

# Ballast Water Risk Assessment Ports of Mumbai and Jawaharlal Nehru India

OCTOBER 2003

*Final Report*

A. C. Anil, C. Clarke,  
T. Hayes, R. Hilliard, G. Joshi,  
V. Krishnamurthy, J. Polglaze,  
S. S. Sawant & S. Raaymakers



URS

MERIDIANS



GloBallast Monograph Series No. 11

# Ballast Water Risk Assessment Ports of Mumbai and Jawaharlal Nehru India

October 2003

## *Final Report*

Arga Chandrashekar Anil<sup>2</sup>, Christopher Clarke<sup>1</sup>,  
Terry Hayes<sup>1</sup>, Robert Hilliard<sup>1</sup>, Geeta Joshi<sup>3</sup>,  
Venkat Krishnamurthy<sup>2</sup>, John Polglaze<sup>1</sup>,  
Subhash S. Sawant<sup>2</sup> & Steve Raaymakers<sup>4</sup>

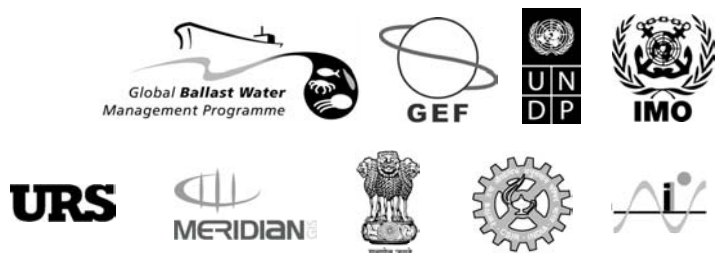

<sup>1</sup> URS Australia Pty Ltd, Perth, Western Australia

<sup>2</sup> National Institute of Oceanography, Dona Paula, Goa

<sup>3</sup> GloBallast - India, Directorate General of Shipping (Ministry of Shipping), Government of India, Mumbai

<sup>4</sup> Programme Coordination Unit, GEF/UNDP/IMO Global Ballast Water Management Programme, International Maritime Organization

---

© International Maritime Organization  
ISSN 1680-3078

*Published in March 2004 by the*  
Programme Coordination Unit  
Global Ballast Water Management Programme  
International Maritime Organization  
4 Albert Embankment, London SE1 7SR, UK  
Tel +44 (0)20 7587 3251  
Fax +44 (0)20 7587 3261  
Email [sraaymak@imo.org](mailto:sraaymak@imo.org)  
Web <http://globallast.imo.org>

***The correct citation of this report is:***

Anil, A.C., Clarke, C., Hayes, T., Hilliard, R., Joshi, G., Krishnamurthy, V., Polglaze, J., Sawant S.S. & Raaymakers, S.  
2004. *Ballast Water Risk Assessment, Ports of Mumbai and Jawaharlal Nehru, India, October 2003: Final Report.*  
GloBallast Monograph Series No. 11. IMO London.

---

The Global Ballast Water Management Programme (GloBallast) is a cooperative initiative of the Global Environment Facility (GEF), United Nations Development Programme (UNDP) and International Maritime Organization (IMO) to assist developing countries to reduce the transfer of harmful organisms in ships' ballast water.

The GloBallast Monograph Series is published to disseminate information about and results from the programme, as part of the programme's global information clearing-house functions.

*The opinions expressed in this document are not necessarily those of GEF, UNDP or IMO.*

## Acknowledgements

---

The Ballast Water Risk Assessment for the Ports of Mumbai and Jawaharlal Nehru was undertaken during 2002 and funded by the GEF/UNDP/IMO Global Ballast Water Management Programme and the Government of India. The study team (Appendix 2) thanks the following for their help and assistance:

Mr Sanjoy Chakrabarty	Former Country Focal Point, Ministry of Shipping, Mumbai.
Mr S. N. Chakrabartty	Director, Planning and Research Department, Mumbai Port Trust.
Dr Gustaaf Hallegraeff	University of Tasmania, Hobart, Tasmania.
Dr Keith Hayes	CSIRO Marine Research, Hobart, Tasmania.
Dr Chad Hewitt	Biosecurity Unit, New Zealand Ministry of Fisheries, Auckland.
Dr Fred Wells	Western Australian Museum, Perth, Western Australia.

The report was formatted and prepared for print by Leonard Webster.

## Acronyms

---

BW	Ballast water
BWM	Ballast water management
BWRA	Ballast Water Risk Assessment
BWRF	Ballast Water Reporting Form (the standard IMO BWRF is shown in Appendix 1)
CFP	Country Focal Point (of the GloBallast Programme in each Pilot Country)
CFP/A	Country Focal Point Assistant
CRIMP	Centre for Research on Introduced Marine Pests (now part of CSIRO Marine Research, Hobart, Tasmania)
CSIRO	Commonwealth Scientific and Industrial Research Organisation (Australia)
CSPO	Commercial Sea Port of Odessa (port authority)
DGS	Directorate General of Shipping (Ministry of Shipping), India
DSS	Decision support system (for BW management)
DWT	Deadweight tonnage (typically reported in metric tonnes)
GIS	Geographic information system
GISP	Global Invasive Species Programme
GloBallast	GEF/UNDP/IMO Global Ballast Water Management Programme
GT	Gross tonnage (usually recorded in metric tonnes)
GUI	Graphic User Interface
IACSS	Information and Analytical Centre for Shipping Safety, State Department of Maritime and Inland Water Transport, Ministry of Transport of Ukraine.
IALA	International Association of Lighthouse Authorities
IBSS	Institute of Biology of the Southern Seas (Odessa Branch) of the Ukraine National Academy of Science
IHO	International Hydrographic Organization
IMO	International Maritime Organization
IUCN	The World Conservation Union
JNP	Jawaharlal Nehru Port
JNPT	Jawaharlal Nehru Port Trust
LAT	Lowest Astronomical Tide
MESA	Multivariate environmental similarity analysis
MEPC	Marine Environment Protection Committee (of the IMO)
MP	Mumbai Port
MPT	Mumbai Port Trust
NEMISIS	National Estuarine & Marine Invasive Species Information System (managed by SERC)
NIMPIS	National Introduced Marine Pests Information System (managed by CSIRO, Australia)
NIO	National Institute of Oceanography (India)
NIS	Non-indigenous species
OBO	Ore/bulk oil tankers (an rather unsuccessful vessel class now used for oil transport only)
OS	Operating System (of any personal or mainframe computer)
PCU	Programme Coordination Unit (of the GloBallast Programme based at IMO London)
PRIMER	Plymouth Routines In Marine Environmental Research
PBBS	Port Biological Baseline Survey
ROR	Relative overall risk
SAP	(Regional) Strategic Action Plan
SERC	Smithsonian Environmental Research Center (Washington DC, United States)
SIPBS	State Inspection for Protection of the Black Sea
VLCC	Very large crude carrier (200,000 – 300,000 DWT)
ULCC	Ultra large crude carrier (over 300,000 DWT)

## Glossary of Terms and Definitions

---

The following terms and definitions are summarised from various sources including Carlton (1985, 1996, 2002), Cohen & Carlton (1995), Hilliard *et al.* (1997a), Leppäkoski *et al.* (2002), Williamson *et al.* (2002) and the GloBallast *BWRA User Guide*. The latter document contains more detailed definitions with explanatory notes, plus a glossary of maritime terms.

<b>Ballast water</b>	Any water and associated sediment used to manipulate the trim and stability of a vessel.
<b>Bioinvasion</b>	A broad based term that refers to both human-assisted introductions and natural range expansions.
<b>Border</b>	The first entrance point into an economy's jurisdiction.
<b>Cost benefit analysis</b>	Analysis of the cost and benefits of a course of action to determine whether it should be undertaken.
<b>Cryptogenic</b>	A species that is not demonstrably native or introduced.
<b>Disease</b>	Clinical or non-clinical infection with an aetiological agent.
<b>Domestic routes/shipping</b>	Intra-national coastal voyages (between domestic ports).
<b>Established introduction</b>	A non-indigenous species that has produced at least one self-sustaining population in its introduced range.
<b>Foreign routes/shipping</b>	International voyages (between countries).
<b>Fouling organism</b>	Any plant or animal that attaches to natural and man-made substrates such as piers, navigation buoys or hull of ship, such as seaweed, barnacles or mussels.
<b>Harmful marine species</b>	A non-indigenous species that threatens human health, economic or environmental values.
<b>Hazard</b>	A situation that under certain conditions will cause harm. The likelihood of these conditions and the magnitude of the subsequent harm is a measure of the risk.
<b>Indigenous/native species</b>	A species with a long natural presence that extends into the pre-historic record.
<b>Inoculation</b>	Any partial or complete discharge of ballast tank water that contains organisms which are not native to the bioregion of the receiving waters (analogous to the potentially harmful introduction of disease – causing agents into a body – as the outcome depends on inoculum strength and exposure incidence).
<b>Intentional introduction</b>	The purposeful transfer or deliberate release of a non-indigenous species into a natural or semi-natural habitat located beyond its natural range.

<b>Introduced species</b>	A species that has been intentionally or unintentionally transferred by human activity into a region beyond its natural range.
<b>Invasive species</b>	An established introduced species that spreads rapidly through a range of natural or semi-natural habitats and ecosystems, mostly by its own means.
<b>Marine pest</b>	A harmful introduced species (i.e. an introduced species that threatens human health, economic or environmental values).
<b>Non-invasive</b>	An established introduced species that remains localised within its new environment and shows minimal ability to spread despite several decades of opportunity.
<b>Pathogen</b>	A virus, bacteria or other agent that causes disease or illness.
<b>Pathway (Route)</b>	The geographic route or corridor from point A to point B (see Vector).
<b>Port Biological Baseline Survey (PBBS)</b>	A biological survey to identify the types of introduced marine species in a port.
<b>Risk</b>	The likelihood and magnitude of a harmful event.
<b>Risk assessment</b>	Undertaking the tasks required to determine the level of risk.
<b>Risk analysis</b>	Evaluating a risk to determine if, and what type of, actions are worth taking to reduce the risk.
<b>Risk management</b>	The organisational framework and activities that are directed towards identifying and reducing risks.
<b>Risk species</b>	A species deemed likely to become a harmful species if it is introduced to a region beyond its natural range, as based on inductive evaluation of available evidence.
<b>Translocation</b>	The transfer of an organism or its propagules into a location outside its natural range by a human activity.
<b>Unintentional introduction</b>	An unwitting (and typically unknowing) introduction resulting from a human activity unrelated to the introduced species involved (e.g. via water used for ballasting a ship or for transferring an aquaculture species).
<b>Vector</b>	The physical means or agent by which a species is transferred from one place to another (e.g. BW, a ship's hull, or inside a shipment of commercial oysters)

## Lead Agencies

---

### Lead Agency for General BW Issues in India:

Contact person: Mr Ajoy Chatterjee,  
Position: Chief Surveyor to the Government of India and GloBallast Programme  
Country Focal Point  
Organization: Directorate General of Shipping, Ministry of Shipping  
Address: Jahaz Bhavan, Walchand Hirachand Marg,  
Mumbai 400 001, India  
Tel: 91-22-2261-1788  
Fax: 91-22-2261-3655  
Email: [cs@dgshipping.com](mailto:cs@dgshipping.com)

### Primary contact for BW Risk Assessments in India:

Contact person: Dr A.C. Anil  
Position: Scientist & Head, Marine Corrosion & Materials Research  
Organization: National Institute of Oceanography  
Address: Dona Paula, Goa 403 004, India  
Tel: 91-832-245-404  
Fax: 91-832-245-602  
Email: [acanil@darya.nio.org](mailto:acanil@darya.nio.org)  
Web: <http://www.nio.org>



## Executive Summary

---

The introduction of harmful aquatic organisms and pathogens to new environments via ships' ballast water (BW) and other vectors has been identified as one of the four greatest threats to the world's oceans. The International Maritime Organization (IMO) is working to address the BW vector through various initiatives. One initiative has been the provision of technical assistance to developing countries through the GEF/UNDP/IMO Global Ballast Water Management Programme (GloBallast).

Core activities of the GloBallast Programme are being undertaken at Demonstration Sites in six Pilot Countries. These sites are the ports at Sepetiba (Brazil), Dalian (China), Mumbai (India), Khark Island (Iran), Odessa (Ukraine) and Saldanha Bay (South Africa). One of these activities (Activity 3.1) has been to trial a standardised method of BW risk assessment (BWRA) at each of the six Demonstration Sites. Risk assessment is a fundamental starting point for any country contemplating implementing a formal system to manage the transfer and introduction of harmful aquatic organisms and pathogens in ships' BW, whether under existing IMO Ballast Water Guidelines (A.868(20)) or the new international Convention.

To maximise certainty while seeking cost-effectiveness and a relatively simple, widely applicable system, a semi-quantitative approach was followed, using widely-supported computer software. The semi-quantitative method aims to minimise subjectivity by using as much quantitative data as possible, to identify the riskiest ballast tank discharges with respect to a Demonstration Site's current pattern of trade. Unlike a fully quantitative approach, it does not attempt to predict the specific risk posed by each intended tank discharge of individual vessels, nor the level of certainty attached to such predictions. However, by helping a Demonstration Site to determine its riskiest trading routes, exploring the semi-quantitative BWRA provides a coherent method for identifying which BW sources deserve more vessel monitoring and management efforts than others.

This report describes the BWRA activity undertaken for the neighbouring ports of Mumbai and Jawaharlal Nehru, which form the Mumbai Demonstration Site and are managed by the Mumbai Port Trust (MPT) and Jawaharlal Nehru Port Trust (JNPT) respectively. This capacity-building activity commenced in January 2002, with URS Australia Pty Ltd (URS) contracted to the Programme Coordination Unit (PCU) to provide BWRA training and software. Under the terms of reference, the consultants worked closely with their counterparts in a project team co-managed by URS and the Country Focal Point Assistant (CFPA) for completing all required tasks. These tasks required two in-country visits by the consultants (in March and October 2002) to install the BWRA software and provide 'hands-on' instruction and guidance. Most of the data collation tasks were undertaken before, between and during these visits, with gap-filling work undertaken by the consultants prior to a short 'project wrap-up' visit in February 2003.

The first step was to collate and computerise data from IMO Ballast Water Reporting Forms (BWRFs) to identify the source ports from which BW is imported to the Demonstration Site. For periods or vessel arrivals where BWRFs were not collected or were incomplete, gap-filling data were extracted from the port shipping records obtained from terminals and offices managed by the MPT and JNPT. These records also helped identify which next ports of call may have been a destination port for any BW taken up at Mumbai.

A multivariate procedure was then used to determine the relative environmental similarity between the Demonstration Site and each of its BW source and destination ports. Comparing port-to-port environmental similarities provides a relative measure of the risk of organism survival, establishment and potential spread. This is the basis of the 'environmental matching' method adopted by the project, which facilitates estimating the risk of BW introductions when the range and types of potentially harmful species that could be introduced from a particular source port are poorly known.

Another objective of the BWRA Activity was to identify 'high-risk' species that may be transferred to and/or from the Demonstration Site. The customised BWRA database provided by URS therefore

contained tables and interfaces for storing and managing the names, distribution and other information on risk species. Thus the taxonomic details, bioregional distribution, native/introduced status and level of threat assigned to a species were stored in the database for display, review and update as well as for the BWRA analysis. For the purposes of the BWRA and its 'first-pass' risk assessment, a risk species was considered to be any introduced, cryptogenic or native species that might pose a threat to marine ecological, social and/or commercial resources and values if successfully transferred to or from a Demonstration Site.

During each visit the consultants worked alongside their Pilot Country counterparts to provide skills-transfer as part of the capacity building objectives of the programme, with the project team divided into three groups. Group A mapped the port and its resources using ArcView GIS. This group included counterparts from the National Institute of Oceanography (NIO) at Goa, who helped collate much of the required GIS data. Group B was responsible for managing the customised Access database supplied by the consultants, and for entering, checking and managing the BW discharge data, as recorded on the BWRFs voluntarily submitted by arriving ships and/or derived from the port's shipping records. Group B used the database to identify BW source and destination ports, and is designed for ongoing input and management of BWRFs. Group C was also based at the NIO, and undertook the environmental matching and risk species components of the Activity, using the PRIMER package to perform the multivariate analyses for determining the environmental distances between Mumbai-JNP and their source and destination ports.

The various BW discharge, environmental matching and risk species data described above were then processed by the database with other risk factors, including voyage duration and tank size, to provide preliminary indication of:

- (a) the relative overall risk posed by each BW source port, and
- (b) which destination ports appeared most at risk from any BW uplifted at the Demonstration Site.

This was achieved using a project standard approach, although the database also facilitates instant modifications of the calculations for exploratory and demonstration purposes. The GloBallast BWRA also adopted a 'whole-of-port' approach to compare the subject port (Demonstration Site) with all of its BW source and destination ports. The project has therefore established at the NIO an integrated database and geographic information system (GIS) that manages and displays:

- ballast water data obtained from arriving ship BWRFs and port shipping records;
- information on the Demonstration Site's navigational, physical and environmental conditions and aquatic resources,
- port-to-port environmental matching data,
- risk species data, and
- risk coefficients and graphical categories of risk for ballast discharges.

The results, which were graphically displayed on user-friendly GIS port and world maps as well as in ranked output tables, help determine the types of management responses.

From the 3,581 vessel visit records and 4,934 associated BW tank records in the 2000-2002 database that was developed for Mumbai-JNP, the total number of identified BW source ports was 82. The three source ports supplying the highest frequencies of BW discharges were Karachi (13.9% of all recorded discharges), Singapore (10.9%) and Colombo (10.1%). These were followed by Jebel Ali (UAE; 8%), Kandla (India; 5.8%), Mohammed Bin Qasim (Pakistan; 4.0%), Dubai and Fujairah (UAE; both 3.9%). Of the 82 identified source ports, the top six and sixteen provided >50% and >75% of all source-identified discharges respectively. The top 24 ports contributed a further 15%, i.e. only 24 (29%) of the 82 source ports accounted for 90% of all source-identified BW discharges.

The total volume of BW discharged from the identified source ports was 2,619,625 tonnes. The source port rankings in terms of the BW volume discharged were similar but not the same as those ranked for discharge frequencies. Thus the source ports providing the largest BW volumes discharged at Mumbai-JNP were Sikka (17.4%), Chennai (12.8%) and Cochin (9.7%) in India, followed by Singapore (8.1%), Dubai (4.8%), Kandla (4.7%) and Surat (4.2%). The top five source ports provided >50% of the total discharged volume, and the next seven ports a further 25%, i.e. only 12 of the identified source ports (14.6%) accounted for >75% of the total source-identified BW discharge at Mumbai-JNP. Of the top 20 ports which accounted for almost 90% of the volume, 12 were in India, two were in the UAE (Dubai and Jebel Ali), and one each in the Netherlands (Rotterdam), Oman (Salalah), Pakistan (Karachi), Singapore, South Africa (Richards Bay) and Sri Lanka (Colombo).

Of the identified 82 BW source ports and 108 potential BW destination ports (i.e. Next Ports of Call), sufficient port environmental data were obtained to include 77% of the former and 71% of the latter in the multivariate similarity analysis by PRIMER. These ports accounted for 95.7% of recorded BW tank discharges and 92.5% of all recorded departures respectively.

To allow all identified BW source and next ports of Mumbai-JNP to be part of the risk assessment, the ports with missing environmental data were provided with environmental matching coefficient estimates, based on their port type and geographic location with respect to the nearest comparable port with a calculated coefficient. The environmental matching results show that Mumbai-JNP has a moderately high environmental similarity to 28% of its trading ports (coefficients between 0.5-0.7). All ports with an environmental matching coefficient >0.535 were humid tropical ports in Asia and Africa that experience relatively intense seasonal monsoons. The most environmentally similar ports to Mumbai-JNP were Mangalore (0.64), Pondichery (C3 estimated), Marmagao (0.62) and Porbandar (0.61). The most environmentally dissimilar ports trading with Mumbai-JNP in 2000-2002 were cool temperate estuary ports in northern Europe (i.e. Hamburg, Ilyichevsk and Antwerpen; all <0.2).

From the 3,581 visit records in the Mumbai-JNP database, the project standard BWRA identified that eleven of the 82 identified source ports represented the highest risk group (in terms of their BW source frequency, volume, voyage duration, environmental similarity and assigned risk species). These ports, nine of which were Indian plus Colombo (Sri Lanka) and Singapore, provided the top 20% of the total relative risk. The highest risk ports were led by Marmagao and Mangalore, with Colombo a close third and the first non-Indian port in the ranking. Karachi (Pakistan) was ranked as a high risk port in 12<sup>th</sup> overall position. The highest ranked ports beyond South Asia were firstly Singapore (ranked 10<sup>th</sup>), followed by Nagasaki in Japan (ranked 14<sup>th</sup> as a high risk port). The highest ranked port beyond the South and East Asian regions was Durban in South Africa (ranked 25<sup>th</sup> with a medium risk). There forty-two source ports ranked in the low (19) and lowest (23) risk categories. These were a mixture of cool, hot-salty and/or riverine ports with a wide distribution. The source port with the lowest risk was the cool freshwater port of Antwerpen in Belgium.

Based on Mumbai-JNP's current pattern of trade (as implied by the 2000-2002 database), the results suggest that BW sourced from Europe and the Red Sea/Gulf pose less threat than many ports in India, other South Asian countries and the humid South-East Asian region. In fact the take-home message was that Mumbai-JNP's current shipping trade causes most risk to be posed by relatively local 'port-hopping' by harmful species that establish and acclimate in other Indian or nearby foreign ports, rather than from remote comparable regions such as the Caribbean and Gulf of Mexico. The presence of the East Asian green lipped mussel (*Perna viridis*) and the Caribbean black-striped mussel (*Mytilopsis sallei*) in the navy dock at Mumbai-JNP conform with this conclusion. Thus *P. viridis* is common in Malay Peninsula and other East Asian ports that regularly trade with Mumbai-JNP, while *M. sallei* is believed to have 'port-hopped' from its earlier establishment inside Visakhapatnam (a major bulk export port on India's east coast that has more frequent vessel arrivals from Atlantic ports than Mumbai-JNP).

Unlike the above fouling organisms, none of the noxious phytoplankton species in the Mumbai-JNP bioregion have clear-cut origins, and some have the potential to increase the incidence and/or severity

of red tides within heavily developed, eutrophying coastal systems. Because India is a large tropical/sub-tropical country with a large number of rapidly urbanising estuarine and lagoonal ports, possible BW mediated transfers of water-borne pathogens (such as cholera) and parasites also needs to be considered. Since cholera outbreaks do occur on the Indian subcontinent, running the BWRA with its calculation options tailored to identifying the transfer of unwanted pathogenic strains of *Vibrio* bacteria or other water-borne diseases would be useful (i.e. for predicting which ports on the subcontinent pose the highest risk to Mumbai-JNP should they report an outbreak, in terms of their shipping and BW trade, voyage duration and environmental similarity).

The results of the project standard 'first-pass' risk assessment imply that Mumbai-JNP is susceptible to unwanted introduced species which establish populations in similar tidal creek/estuarine environment harbours between Karachi and the Pondichery-Visakhapatnam region. This appears logical given Mumbai-JNPs biogeographic location and current pattern of trade, and it indicates that the relative risk coefficients should provide a useful benchmark for exploring the risk formula and refining the database. It is also worth noting that the BWRA activity is based on two years of shipping data, so the results can change if there is any major change to the current (2000-2002) pattern of Mumbai-JNP trade assembled in the database.

The 'port-hopping' risk mentioned above signifies that India's domestic port-to-port shipping is an important vector and therefore, as with other large nations such as Australia, warrants active BW management and use of BWRFs, especially to help determine the intra-national pattern of BW transfers. Thus delineation of BW-mediated species invasions and public health risks for any Indian port will need to measure and contrast the influence of domestic arrivals versus international arrivals, together with port proximity (facilitating both natural and BW tank dispersion of organisms), and use of a more port-oriented rather than bioregional approach for the database's storage and treatment of the risk species data.

In the case of the 'reverse' BWRA for Mumbai-JNP, there is no doubt both ports annually 'export' a considerable volume of ballast water, with most of this being transferred to other ports in relatively small but frequent quantities within the tanks of container ships, general cargo ships, small bulk carriers, ro-ro vessels and vegetable oil (chemical) tankers. The 2000/2001 ratio of total imported cargo to total exported cargo indicates that some ~1.5 million tonnes of BW is exported annually.

The most frequent destination port appeared to be Colombo, which has a moderate environmental matching as it experiences a comparable climate regime but is a breakwater harbour located on an open sandy coast without significant tidal creek habitats or major river. Ports more at risk from unwanted species transfers from Mumbai-JNP were identified as Mangalore, Pondichery, Marmagao, Porbandar, Muhammad Bin Qasim and Singapore. It was clear that Mumbai-JNP forms a significant hub in the Indian Ocean, with most trading voyages occurring between the Red Sea and Indo-Malay peninsula. Of the top 17 ports accounting for 80% of the destinations recorded by departing vessels, five were Indian, seven were in the Middle East and others were single ports in Malaysia, Pakistan, Singapore, Sri Lanka and United States. Of the risk species assigned to the Mumbai-JNP bioregion, fouling tube worms, bivalve molluscs and potentially noxious phytoplankton were identified as potentially the most economically and ecologically harmful organisms.

Of the various BWRA objectives and tasks, reliable identification of destination ports that receive the largest amounts of BW exported from Mumbai-JNP was the least successful task. It was confounded by the lack of specific questions on the IMO-standard BWRFs, and the uncertainty of knowing if the Next of Port Call recorded on a BWRF is where BW is actually discharged. Thus presently there is no mechanism enabling a 'reverse BWRA' to be undertaken reliably. In the case of Mumbai-JNP, many visiting vessels types do not uniformly discharge or uptake their full capacity of ballast water (especially Ro-Ro vessels, general cargo ships and container vessels), with many of their previous and next ports of call involving part cargo discharge and loading. If more reliable forward-looking BWRA's are to be undertaken to identify destination ports in the future, supplementary questions will

need to be added to the present BWRP, including the names of the three last ports of call as well as the port where discharges from each partially or completely ballasted tank are predicted.

The main objectives of the BWRA Activity were successfully completed during the 14 month course of this project, with the various tasks and exploratory/demonstration software providing a foundation to facilitate the regional promulgation of further BW management activities by India. Project outputs included a trained in-country risk assessment team base at the National Institute of Oceanography (NIO) in Goa, and an operational BWRA system and *User Guide* for use as a demonstration tool in the region. These have improved India's ability to provide assistance, technical advice, guidance and encouragement to other port States in South Asia.

# Table of Contents

---

<b>Acknowledgements</b> .....	<b>i</b>
<b>Acronyms</b> .....	<b>ii</b>
<b>Glossary of Terms and Definitions</b> .....	<b>iii</b>
<b>Lead Agencies</b> .....	<b>v</b>
<b>Executive Summary</b> .....	<b>vi</b>
<b>1 Introduction and Background</b> .....	<b>1</b>
<b>2 Aims and Objectives</b> .....	<b>5</b>
<b>3 Methods</b> .....	<b>6</b>
3.1 Overview and work schedule.....	6
3.2 Resource mapping of the demonstration port.....	9
3.3 De-ballasting/ballasting patterns .....	10
3.4 Identification of source ports.....	11
3.5 Identification of destination ports.....	12
3.6 BWRF database.....	13
3.7 Environmental parameters.....	15
3.8 Environmental similarity analysis.....	17
3.9 Risk species .....	18
3.10 Risk assessment.....	22
3.11 Training and capacity building .....	27
3.12 Identification of information gaps.....	29
<b>4 Results</b> .....	<b>30</b>
4.1 Description of port.....	30
4.2 Resource mapping.....	32
4.3 De-ballasting/ballasting patterns .....	34
4.4 Identification of source ports.....	41
4.5 Identification of destination ports.....	44
4.6 Environmental similarity analysis .....	45
4.7 Risk species threat.....	50
4.8 Risk assessment results .....	54
4.9 Training and capacity building .....	57
4.10 Identification of information gaps.....	58
<b>5 Conclusions and Recommendations</b> .....	<b>60</b>
5.1 Recommendations .....	60
5.2 BWRA recommendations and plans by Pilot Country .....	61
<b>6 Location and maintenance of the BWRA System</b> .....	<b>62</b>
<b>References</b> .....	<b>63</b>

**APPENDIX 1: Copy of IMO Ballast Water Reporting Form**

**APPENDIX 2: Risk Assessment Team for Mumbai-JNP**

**APPENDIX 3: Check-list of project requirements**

**APPENDIX 4: Information sources used for collating Port Environmental Data**

**APPENDIX 5: Sources and references of Risk Species information**

**APPENDIX 6: Name, UN code, coordinates and environmental parameters of the 357 ports used for the multivariate similarity analyses for all Demonstration Sites**

**APPENDIX 7: Consultants' Terms of Reference**

<b>Figure 1.</b>	Locations of the six GloBallast Demonstration Sites and their various ballast water source and destination ports.....	3
<b>Figure 2.</b>	Location of Mumbai-JNP and other ports in South Asia .....	4
<b>Figure 3.</b>	Schematic of the GloBallast BWRA system .....	6
<b>Figure 4.</b>	Thematic layers used for the Port Map GIS.....	9
<b>Figure 5.</b>	Working page of the Excel spreadsheet used to estimate BW discharges .....	12
<b>Figure 6.</b>	The three tabs of the GUI used for entering the BWRF data .....	15
<b>Figure 7.</b>	Part of the GIS world map of marine bioregions, showing the code names of those in the South Asian region .....	19
<b>Figure 8.</b>	Complete GIS world map showing the marine bioregions [to improve clarity, not all bioregion codes are shown in this example].....	20
<b>Figure 9.</b>	Database GUI used for manipulating the BWRA calculation and weightings .....	23
<b>Figure 10.</b>	Annual wind rose typical of the Mumbai region .....	30
<b>Figure 11.</b>	Part of the GIS Port Map showing the navigation, infrastructure and active berth layers for the ports of Mumbai and JNP. ....	32
<b>Figure 12.</b>	Part of the GIS Port Map showing the active berth and marine habitat layers.....	33
<b>Figure 13.</b>	BW discharge statistics displayed by GIS port map for the Mumbai docks .....	36
<b>Figure 14.</b>	BW discharge statistics displayed by GIS port map for the Pir Pau terminal .....	37
<b>Figure 15a.</b>	BW discharge statistics displayed for the Butcher Island products terminal .....	37
<b>Figure 15b.</b>	BW discharge statistics displayed for the Butcher Island crude terminal .....	38
<b>Figure 16a.</b>	BW discharge statistics displayed by the port map for the JNP Ro-Ro terminal.....	38
<b>Figure 16b.</b>	BW discharge statistics displayed for the JNP Chemical terminal.....	39
<b>Figure 17a.</b>	BW discharge statistics displayed for the JNP Container terminal .....	39
<b>Figure 17b.</b>	BW discharge statistics displayed for the JNP Dry Bulk terminal .....	40
<b>Figure 18.</b>	GIS output showing the location and relative importance of BW source ports with respect to frequency of tank discharges (C1) at Mumbai-JNP.....	42
<b>Figure 19.</b>	GIS output showing location and relative importance of the source ports with respect to the volume of BW discharges (C2) recorded for Mumbai-JNP. ....	42
<b>Figure 20.</b>	GIS output showing the location and frequency of destination ports, recorded as the Next Port of Call in the Mumbai-JNP BWRFs and shipping records. ....	44
<b>Figure 21.</b>	GIS outputs showing the location and environmental matching coefficients (C3) of BW source ports identified for Mumbai-JNP.....	46
<b>Figure 22.</b>	GIS outputs showing the location and environmental matching coefficients (C3) of the destination ports identified for Mumbai-JNP. ....	46
<b>Figure 23.</b>	GIS output showing the location and risk species threat coefficients (C4) of the BW source ports identified for Mumbai-JNP.....	51
<b>Figure 24.</b>	GIS outputs showing the location and categories of relative overall risk (ROR-cat) of source ports identified for Mumbai-JNP.....	54
<b>Figure 25.</b>	Frequency distribution of the standardised ROR values.....	57

# 1 Introduction and Background

---

The introduction of harmful aquatic organisms and pathogens to new environments via ships' ballast water (BW) and other vectors, has been identified as one of the four greatest threats to the world's oceans. The International Maritime Organization (IMO) is working to address the BW vector through a number of initiatives, including:

- adoption of the *IMO Guidelines for the control and management of ships' ballast water to minimize the transfer of harmful aquatic organisms and pathogens* (A.868(20));
- developing a new international legal instrument (*International Convention for the Control and Management of Ships' Ballast Water and Sediments*, as adopted by IMO in February 2004); and
- providing technical assistance to developing countries through the GEF/UNDP/IMO Global Ballast Water Management Programme (GloBallast).

Core activities of the GloBallast Programme are being undertaken at Demonstration Sites in six Pilot Countries. These sites are the ports at Sepetiba (Brazil), Dalian (China), Mumbai (India), Khark Island (Iran), Odessa (Ukraine) and Saldanha Bay (South Africa). Activities carried out at the Demonstration Sites will be replicated at additional sites in each region as the programme progresses (further information at <http://globallast.imo.org>).

One of GloBallast's core activities (Activity 3.1) has been to trial a standardised method of BW risk assessment (BWRA) at each of the six Demonstration Sites. Risk assessment is a fundamental starting point for any country contemplating implementing a formal system to manage the transfer and introduction of harmful aquatic organisms and pathogens in ships' BW, whether under the existing IMO Ballast Water Guidelines (A.868(20)) or the new Convention.

A port State may wish to apply its BW management regime uniformly to all vessels that call at its ports, or it may wish to assess the relative risk of these vessels to its coastal marine resources and apply its regime selectively. Uniform application or the 'blanket' approach offers the advantages of simplified administration and no requirement for 'judgement calls' to be made. This approach also requires substantially less information management effort. If applied strictly, the uniform approach offers greater protection from unanticipated bio-invaders, as it does not depend on the reliability of a decision support system that may not be complete. However, the key disadvantage of the strict blanket approach are the BW management costs imposed on vessels which otherwise might not be forced to take action. It also requires a substantial vessel monitoring and crew education effort to ensure all foreign and domestic flagged ships are properly complying with the required BW management actions.

A few nations have started to develop and test systems that allow more selective application of BW management requirements, based on voyage-specific risk assessments. This 'selective' approach offers to reduce the numbers of vessels subject to BW controls and monitoring, and is amenable to nations that wish to reduce the introduction, and/or domestic spread, of 'targeted' marine species only. More rigorous measures can be justified on ships deemed to be of high risk if fewer restrictions are placed on low risk vessels.

For countries/ports that choose the selective approach, it is essential to establish an organized means of evaluating the potential risk posed by each arriving vessel, through a 'Decision Support System' (DSS). However, this approach places commensurate information technology and management burdens on the port State, and its effectiveness depends on the quality of the information and database systems that support it. A selective approach that is based on a group of targeted species may also leave the country/port vulnerable to unknown risks from non-targeted species.



Before a port State decides on whether to adopt the blanket or the selective approach, it needs to carry out some form of risk assessment for each port under consideration. Ballast water risk assessments (BWRAs) can be grouped into three categories<sup>1</sup>:

- **Qualitative Risk Identification:** this is the simplest approach, and is based on subjective parameters drawn from previous experience, established principals and relationships and expert opinion, resulting in simple allocations of ‘low’, ‘medium’ and ‘high’ risk. However it is often the case that subjective assessments tend to overestimate low probability/high consequence events and underestimate higher probability/lower consequence events (e.g. Haugom *et al*, in Leppäkoski *et al*. 2002).
- **Semi-Quantitative Ranking of Risk:** this ‘middle’ approach seeks to increase objectivity and minimise the need for subjective opinions by using quantitative data and ranking of proportional results wherever possible. The aim is to improve clarity of process and results, thereby avoiding the subjective risk-perception issues that can arise in qualitative approaches.
- **Quantitative Risk Assessment:** this is the most comprehensive approach which aims to achieve a full probabilistic analysis of the risk of BW introductions, including measures of confidence. It requires significant collation and analysis of physico-chemical, biological and voyage-specific data, including key lifecycle and tolerance data for every pre-designated species of risk (‘target species’), port environmental conditions, ship/voyage characteristics, the BW management measures applied, and input and evaluation of all uncertainties. The approach requires a high level of resourcing, computer networking and sophisticated techniques that are still being developed<sup>1</sup>.

The purpose of GloBallast Activity 3.1 has been to conduct initial, first-pass BWRAs for each Demonstration Site. To maximise certainty while seeking cost-effectiveness and a relatively simple, widely applicable system, the middle (semi-quantitative) approach was selected.

The first step of the GloBallast method is to collate data from IMO Ballast Water Reporting Forms (BWRFs) (as contained in Resolution A.868(20); see Appendix 1) to identify the source ports from which BW is imported to the demonstration port. For periods or vessel arrivals where BWRFs were not collected or are incomplete, gap-filling data can be extracted from port shipping records.

Source port/discharge port environmental comparisons are then carried out and combined with other risk factors, including voyage duration and risk species profiles, to give a preliminary indication of overall risk posed by each source port. The results help determine the types of management responses required, while the BWRA process provides a foundation block enabling application of more sophisticated BW management DSSs by Pilot Countries.

The GloBallast approach is not the only one available but is considered to combine the best elements of the semi-quantitative method to provide useful results within the available budget (US\$250,000 spread across the six pilot countries). It has also taken a ‘whole-of-port’ approach which compares the subject port (Demonstration Site) with all of its BW source and destination ports. The outputs include published reports, trained in-country risk assessment teams and an operational BWRA system for use as demonstration tools in each of the six main developing regions of the world, plus a platform and database to facilitate further DSS development. The GloBallast BWRA activity has therefore established an integrated database and information system to manage and display:

- ballast water data from arriving ship BWRFs and port shipping records;
- data on the demonstration port’s physical and environmental conditions and aquatic resources,
- port-to-port environmental matching data,

---

<sup>1</sup> for further details see the GloBallast *BWRA User Guide*.

- risk species data, and
- ballast water discharge risk coefficients.

The results provide a knowledge base that will help the Pilot Countries and other port States to evaluate the risks currently posed by BW introductions, identify high priority areas for action, and decide whether to apply a blanket or selective BW management regime. If a selective regime is adopted, vessel and voyage-specific risk assessments can then be applied using systems such as those being developed and trialled by the Australian Quarantine & Inspection Service (AQIS Decision Support System), Det Norsk Veritas in Norway (EMBLA system) and the Cawthron Institute in New Zealand (SHIPPING EXPLORER), and/or by further development of the GloBallast system. If a uniform approach is adopted, the results help identify which routes and vessel types warrant the most vigilance in terms of BW management compliance checking and verification monitoring, including ship inspections and ballast tank sampling.

The geographical spread and broad representativeness of the six Demonstration Sites also means that the results help plug a very large gap in the existing global knowledge base. Figure 1 indicates the broad global spread of the GloBallast risk assessment activity. As a result of this activity, comprehensive data are now available on source port and destination port linkages, environmental parameters, environmental matching coefficients, risk species and relative overall risk of BW transfers for the six GloBallast Demonstration Sites and a total of 723 ports around the world. Project outcomes will therefore place governments, scientists, the shipping industry and the general public in a stronger, more enlightened position to deal with the BW problem.



**Figure 1.** Locations of the six GloBallast Demonstration Sites and their various ballast water source and destination ports.

This report describes and presents the results of the first Ballast Water Risk Assessment (BWRA) carried out for the neighbouring Mumbai and Jawaharlal Nehru ports (Mumbai-JNP) during 2002. This GloBallast Demonstrate Site comprises a large and historic ‘city’ port and associated terminals, plus a modern container and bulk terminal port developed on reclaimed land on the nearby Sheva Island within Mumbai bay (Figure 2).

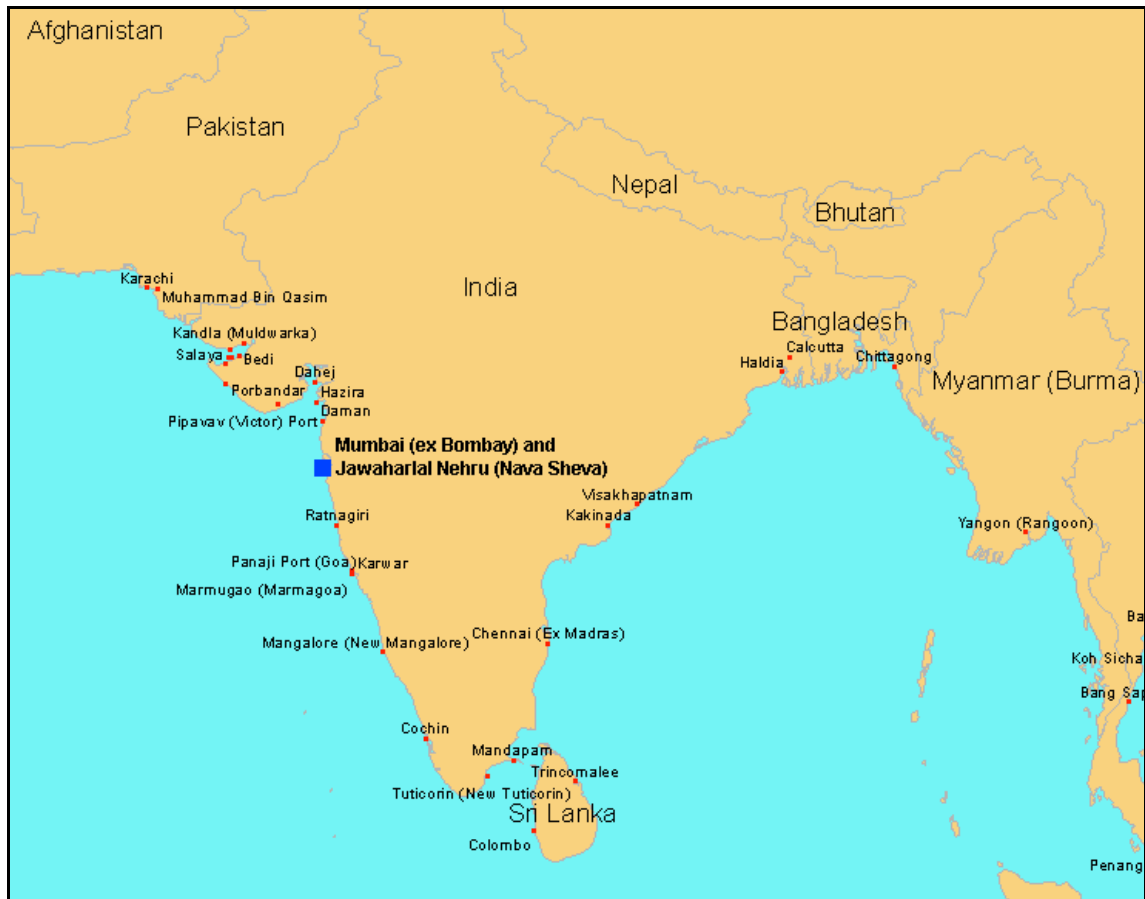

*Figure 2. Location of Mumbai-JNP and other ports in South Asia*

## **2 Aims and Objectives**

---

The aims of the GloBallast BWRA for Mumbai-JNP were set by the GloBallast Programme Coordination Unit (PCU), in accordance with Terms of Reference developed by the PCU Technical Adviser (Appendix 7) and were to:

1. Assess and describe as far as possible from available data, the risk profile of invasive aquatic species being both introduced to and exported from Mumbai-JNP in ships' BW, and to identify the source ports and destination ports posing the highest risk for such introductions.
2. Help determine the types of management responses that are required, and provide the foundation blocks for implementing a more sophisticated BW management system for Mumbai-JNP.
3. Provide training and capacity building to in-country personnel, resulting in a fully trained risk assessment team and operational risk assessment system, for ongoing use by the Pilot Country, replication at additional ports and use as a demonstration tool in the region.

The specific objectives of the BWRA for Mumbai-JNP were to:

1. Identify, describe and map on a Geographic Information System (GIS) all coastal and marine resources (biological, social/cultural and commercial) in and around the port that might be impacted by introduced marine species.
2. Characterise, describe and map (on GIS) de-ballasting and ballasting patterns in and around the port including locations, times, frequencies and volumes of BW discharges and uptakes.
3. Identify all ports/locations from which BW is imported (source ports).
4. Identify all ports/locations to which BW is exported (destination ports).
5. Establish a database at the nominated in-country agency for the efficient ongoing collection, management and analysis of the data collected at Mumbai-JNP via standard IMO BWRFs.
6. Characterise as far as possible from existing data, the physical, chemical and biological environments for Mumbai-JNP and each of their source and destination ports.
7. Develop environmental similarity matrices and indices to compare Mumbai-JNP with each of their source ports and destination ports, as a key basis of the risk assessment.
8. Identify as far as possible from existing data, any high-risk species present at the source ports that might pose a threat of introduction to Mumbai-JNP, and any high-risk species present at this port that might be exported to a destination port.
9. Identify any information gaps that limit the ability to undertake the aims and objectives and recommend management actions to address these gaps.

## 3 Methods

### 3.1 Overview and work schedule

The BWRA Activity for Mumbai-JNP was conducted by URS Australia Pty Ltd (URS) under contract to the GloBallast Programme Coordination Unit (PCU), in accordance with the Terms of Reference (Appendix 7). The consultants worked alongside their Pilot Country counterparts during the country visits to provide training and skills-transfer as part of the capacity building objectives of the programme. Structure and membership of the joint project team is shown in Appendix 2.

The consultants adopted an innovative, modular approach that integrated three widely used computer software packages to provide a user-friendly tool for conducting, exploring and demonstrating semi-quantitative BWRA. As shown in Figure 3, the key software comprised:

- Microsoft Access - for the main database;
- PRIMER 5 [*Plymouth Routines In Marine Environmental Research*] - a versatile multivariate analysis package from the United Kingdom enabling convenient multivariate analysis of the port environmental data; and
- ESRI ArcView 3.2 Geographic Information System (GIS) - to graphically display the results in a convenient, readily interpretable format using port and world maps.

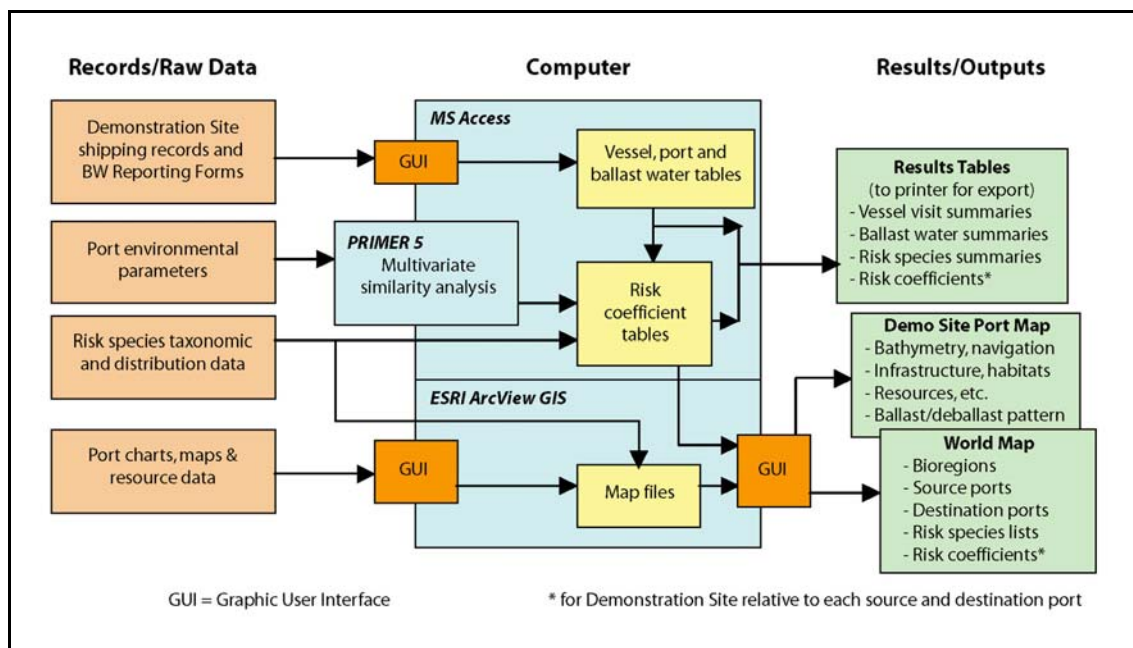

Figure 3. Schematic of the GloBallast BWRA system

The work schedule commenced with project briefing meetings with personnel from all six Demonstration Sites to arrange logistics and resource needs, during the third meeting of the GloBallast Programme's Global Task Force, held in Goa, India on 16-18 January 2002 (Appendix 3). The majority of tasks subsequently undertaken for Mumbai-JNP were completed during two in-country visits by the consultants (11-15 March and 11-22 November 2002), with information searches and data collation undertaken by both consultant and pilot country team members between and after these visits. A two-day 'project wrap-up' visit was subsequently made by one of the consultants, working at the Directorate General of Shipping (DGS) in Mumbai on 19-20 February 2003.

The specific tasks of the week-long first visit were to:

- Install and test the Access, ArcView and PRIMER software and the functionality of the computer system at Mumbai (DGS Offices) and the National Institute of Oceanography (NIO) at Goa.
- Familiarise the project team with the GloBallast BWRA method by seminar and work-shopping.
- Visit the MPT and JNPT offices and undertake a tour of the port facilities with the Deputy Harbour Masters to obtain information on trading patterns and ballasting practises of visiting ships and improve understanding of the surrounding coastal habitats and marine resources.
- Review available BWRFs and port shipping records to identify trading patterns, vessel types, key BW source ports and likely destination ports.
- Commence GIS guidance and developing the port map for the Demonstration Site.
- Commence training on the use of the various Graphic User Interfaces (GUI) of the Access Database for inputting and editing BW discharge data.
- Check available port environmental data and identify potential in-country and regional sources of same.
- Commence listing risk species and identifying potential in-country or regional sources of same.
- Identify critical information gaps and the data assembly work required before the second visit.

During the longer second visit by the consultants, the environmental and risk species data were added to the database, more vessel arrival, BW and voyage data were entered and checked, the first BWRA was undertaken, and a workshop was held to review the initial results and identify future actions.

During the third visit in February 2003, the consultants supplied the CFP-A with updated versions of the database and *BWRA User Guide* on CD-ROM, which included additional source port environment and risk species data (as obtained from the BWRA Activities conducted at the other five Demonstration Sites). The results of the March 2003 version, plus subsequent corrections to some of the vessel visit records and environmental matching assignments (made by the CFP-A in consultation with URS), are reported here.

Throughout the schedule, the joint project team was divided into three groups to facilitate training and progress (Appendix 2). Group A was responsible for developing the port map and graphically displaying results via the GIS. All coastal and marine resources (biological, social/cultural and commercial) in and around the port that might be impacted by aquatic bio-invasions were mapped using the ArcView GIS, using specific layers to show the bathymetry, navigation aids, port infrastructure and tables of the port's de-ballasting/ballasting patterns (including frequencies and volumes of discharges and uptakes for the berth locations).

Group B was responsible for managing the customised Access database supplied by the consultants, and for entering, checking and managing the BW data, as collated from the BWRFs submitted by arriving ships (and/or derived from shipping records for periods or arrivals when BWRFs were not obtained or incomplete). The Access database was designed for ongoing input and management of future BWRFs.

**The requirement for arriving ships to submit to the relevant port State authority a completed form that complies with the IMO BWRF (Appendix 1) is a fundamental and essential first basic step for any port State wishing to commence a BW management programme<sup>2</sup>.**

---

<sup>2</sup> Several port States (e.g. Australia) and Demonstration Sites (e.g. Dalian, Odessa, Sepetiba) have produced their own BWRFs, the latter using translated formats to permit improved BWRF understanding and

Database management was subsequently transferred to the NIO Group C counterparts in Goa, where it was used to identify source and destination ports, enter the Group C data and perform the first BWRAs.

Of the three Group B counterparts assigned by the CFP to the BWRA activity, two were the Dock Masters for the Ports of Mumbai and Jawaharlal Nehru who had very limited available time for Database instruction, preferring to act as co-ordinators for the supply of port shipping record information and collected BWRFs. The third Group B counterpart was the GloBallast Programme CFP-A based at the DGS office in Mumbai, who was assigned the role of entering supplied BWRFs into the BWRA database. Although it was advised that this would be a heavy work load and there was a project requirement to train more than single counterparts, no other counterparts were assigned.

Group C was responsible for collating the port environmental and risk species data, undertaking port-to-port environmental similarity analyses and performing the BWRA. Thirty four environmental variables were collated for the Demonstration Site and the majority of its source and destination ports<sup>3</sup>, including sea water and air temperatures, salinities, seasonal rainfall, tidal regimes and proximity to a standardised set of intertidal and subtidal habitats. Where water temperature data or salinity data could not be found for a source or destination port, values were derived for the riverine, estuarine or coastal location of the port with respect to the temperature and salinity data ranges of its IUCN marine bioregion, plus ocean maps depicting sea surface temperature/salinity contours at quarter degree and degree scales (as obtained from CRIMP [now CSIRO Marine Research], URS and other sources; Appendix 4).

The multivariate analysis of the port environmental data was undertaken using the *PRIMER* package, with the similarity values between Mumbai-JNP and its source and destination ports converted into environmental matching coefficients then added to the database. Species in or near source ports that were deemed to pose a threat if introduced to the Demonstration Site, together with species at the Demonstration Site that might be exported to a destination port, were identified from all available sources found by the project team.

These sources included preliminary results from the Port Biological Baseline Surveys (PBBS; as recently completed at each Demonstration Site by another GloBallast Activity), plus searches of 'on-line' databases such as those under ongoing development by the Smithsonian Environmental Research Center (SERC), the Australian Centre for Research on Introduced Marine Pests (CRIMP; now CSIRO Marine Research), the Baltic Regional Marine Invasions Database and the Global Invasive Species Programme (GISP) (Appendix 5). The species taxonomic information and bioregional distributions were also added to the Access database. The combined BW discharge, environmental matching and risk species coefficients provided the basis of the semi-quantitative risk assessment.

Graphic User Interfaces (GUIs) customised by the consultants for the Access database and ArcView GIS were used to generate results tables and graphical outputs that were displayed on interactive maps of the Demonstration Site and World bioregions. The various BWRA outputs can be printed, exported to other software, or viewed interactively to enhance the user-friendliness and management utility of the system.

---

completion by local shipping. Such BWRFs need to include all questions of the IMO standard form. Problems arising from voluntary submission of BWRFs are described in Section 4.10.

<sup>3</sup> The complete set of source and destination ports identified for the six Demonstration Sites (723) remained unknown until the end of the BWRF/port record data collation, database entry and checking phases (i.e. end of the second round of in-country visits; 22 December 2002). A gap-filling effort was made by the consultants to obtain the environmental parameters during January 2003, but this had to focus on the most frequently recorded of these ports, since there was insufficient time or resources to order charts and search for the environmental data for all of them (the majority of which were associated with few or only single vessel arrivals). For these ports, their environmental matching values were provided by a comparison method described in Section 4.6.

The methods used to attain each objective of the BWRA Activity are summarised in the following sections, with technical details of the risk assessment procedures provided in the GloBallast *BWRA User Guide*. This manual was developed by the consultants to facilitate BWRA training and demonstrations for all six GloBallast Pilot Countries. The *BWRA User Guide* comprises a separate document that accompanies this report, and is available from the GloBallast PCU (<http://globallast.imo.org>).

### 3.2 Resource mapping of the demonstration port

The port resources were mapped using ArcView GIS to display the bathymetric, navigational and infrastructure features, including habitats and social-cultural features. The scope of the Mumbai-JNP port map includes the open seaway west of Mumbai, the dredged Jawahar Dweep approach channel and nearby anchorages, and all docks and terminals at Mumbai and JNP. The GIS port map also extends east and south to include coastal habitats along the Thane and Dharamtar Creeks.

It was confirmed there were no vector-based electronic nautical charts for the Mumbai region. NIO counterparts therefore generated the baseline bathymetry and navigation layers by digitising salient details of port infrastructure, navigation channels and anchorages from three nautical charts obtained by the consultants from a chart agent in Mumbai. These were Admiralty hydrographic charts No. 2621 (1:60,000) covering the greater Mumbai-JNP area, No. 2624 (1:20,000) for the Port of Mumbai, and No. 2627 (1:20,000) for JNP.

Based on the guidance and instructions left by the consultants during the first visit, NIO cartographers digitally captured urban infrastructure and social cultural information from these charts, with the overlapping and more detailed features on the 1:20,000 charts taking precedence, and attribute data attached to the key graphical objects. Point and pattern symbols developed by NIO for the navigational features were based on the international IHO/IALA system.

During the consultants second visit, the intertidal habitats delineated from the chart information were supplemented by subtidal and other habitat information provided by Group C. A berth layer was added and gap-filling work on the symbol and graphical objects was completed. For clarity and convenience of data management and display, each ‘theme’ of information was added by NIO as a separate layer that followed the BWRA project-standard scheme shown in Figure 4.

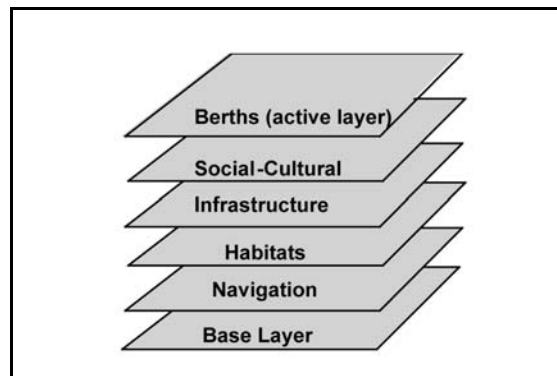

**Figure 4.** Thematic layers used for the Port Map GIS

The protocol for the five main layers are described in the *BWRA User Guide* and summarised below:

**Base Layer:** The base layer includes important planimetric features such as depth contours, jetties, important channels and other permanent or at least semi-permanent ‘reference’ features that are unlikely to change or move. The key features of the base layer for Mumbai-JNP comprised:



- Coastlines of the mainland and various islands within greater Mumbai-JNP area (as depicted by the high tide mark on the nautical charts).
- The low tide mark (i.e. the 0 metre bathymetric contour of hydrographic charts).
- 5 metre isobath (often the first continuous contour below the low tide mark).
- 10 metre, 20 metre and 30 metre isobaths.
- Edges of the main shipping channels (often blue or purple lines showing the boundary of depths maintained by port dredging programs).

The colour scheme of the base layer followed that of standard nautical charts to maintain the familiar land/sea depth effect.

**Navigational Layer:** The standard navigational symbols of the IHO/IALA system were followed as closely as possible. ArcView's symbol libraries do not contain these international navigation symbols, and convenient third-party symbology could not be found despite extensive searches of public domain web resources. Closest-match point and pattern symbols were therefore developed for this purpose, using the UK Hydrographic Office Chart No. 5011 (= IHO INT 1) as the source.

**Habitat Layer:** This layer used a standardised, logical colour scheme to facilitate recognition of the main intertidal and subtidal habitat types in and near the port. It contains coastal habitat information assembled by Group C, with some of the natural and artificial habitat boundaries based on notes and map annotations made by BWRA team members during a port tour undertaken on an MPT launch at the beginning of the second visit in November 2002. Delineation of some intertidal and subtidal habitat boundaries was supplemented from seafloor and coastal features displayed on the hydrographic charts described above. These included the intertidal mud flats, sand beaches and rocky shorelines, plus symbols denoting the presence of sand, mud or rocky substrate

**Infrastructure Layer:** This shows the urban and developed land areas near the port, including major and minor roads and railway lines.

**Social-Cultural Layer:** Social-cultural features include sites or boundaries of recognised coastal reserves, wildlife conservation areas, fishery areas and/or aquaculture sites, including any recognised recreational fishing sites. Coastal or marine sites of cultural, heritage or archaeological significance, such as an important temple or historic shipwreck site, form part of this layer.

**Berth Layer:** An 'active' berth layer was added to show the principal berthing and anchoring areas at Mumbai-JNP. Their names and numbering system were based on information in MPT and JNPT publications obtained by Group B. The same nomenclature was also used for the berthing area information stored in the Access database, to allow display of statistical summaries of the BW source and discharge data on the correct locations of the GIS port map (the *GloBallast BWRA User Guide* shows how the database-GIS link is established).

### 3.3 De-ballasting/ballasting patterns

The deballasting/ballasting patterns at Mumbai-JNP are very complex owing to the number and geographic spread of the various docks, terminals and offshore cargo-transfer points, and the wide range of domestic and overseas vessel types using the port. Port trade and ballasting/deballasting activities were discussed during consultant/counterpart meetings at DGS (11 March and 14 November 2002), the port tour (12 March 2002) and at JNPT (12-13 November 2002). Pilotage rules, draft requirements, container barging and cargo-transfer activities in the anchorage areas were also discussed during these meetings.

Further information was gleaned from spreadsheet records of non-standard BWRFs that MPT and JNPT had commenced using on a voluntary basis in August 2000<sup>4</sup>, plus analysis of available BWRFs and port shipping records held at JNPT and the spreadsheet records obtained for the MPT, Pir Pau and Butcher Island terminals. This work was undertaken during and after both the first and second visits to improve the database visit record size and reliability, and to check, gap-fill, modify or remove incomplete, absent or illogical database entries for BWRFs that had not been archived and were therefore unavailable.

For the terminals dedicated to importing crude, exporting refined products and importing chemical liquids it was relatively simple to check (or identify) what BW discharge or uptake volumes were occurring, although BW sources for many visits remained unclear (records using the *Last Port of Call* instead of specifically reported BW source port/s can be misleading). In the case of the container, break-bulk, Ro-Ro and general cargo trade, the majority of vessels involved were either part discharging cargo, part loading cargo or a combination of both, and thus it was not possible to determine specific sources and volumes of discharged BW unless reasonably complete BWRFs were available (Section 3.1).

### 3.4 Identification of source ports

To provide confidence as to which ports were predominant sources of BW discharged at Mumbai-JNP, over 3000 vessel visit records spanning arrivals from January 2000 to July 2002 were collated from three main sources and added to the Access database. These sources were:

- (a) Excel spreadsheet records developed at DGS that contained vessel visit and BW entries estimated from port shipping records for January-August 2000, plus records of BWRFs collected on a voluntarily basis from August 2000 to December 2001 by MPT (226 records) and JNPT (1832 records);
- (b) 965 records from part-archived BWRFs, as entered by CFP-A into various ‘monthly’ databases between the consultants first and second visits and by Group B members during and after the second visit;
- (c) additional spreadsheets of port records containing 558 tanker visits between April 2001 and March 2002, as obtained for the Pir Pau and Butcher Point terminals from MPT’s Planning & Research Department during the consultants second visit.

A total of 3581 visit records and details for 1018 vessels had therefore been entered into the final database by the time of the consultants wrap-up visit in February 2003. For vessel visits recorded before BWRFs were collected, or which had submitted incomplete or no form following the generally port-wide introduction of BWRFs in August 2000, gap-filling details were sought from port shipping records. However these records show only the *Last Port of Call*, which may not be the BW source. To identify which last ports of call were probable BW sources, cross-checks were made of source ports and last ports of call reported in other BWRFs by the same or similar types of vessel using the same terminal.

The Lloyds *Fairplay Port Guide* and *Lloyds Ship Register*<sup>5</sup> were also used to help confirm source port trade and to check or add the name, IMO number, type and DWT of arriving ships respectively. Before any new port was added to the database, the port and country name spelling, its location coordinates, bioregion and unique UN Port Code number were checked using the Lloyds *Fairplay World Ports Guide* and world bioregion list in the database (port data input is detailed in the *GloBallast BWRA User Guide*).

<sup>4</sup> These spreadsheet records listed basic vessel visit information, including vessel name, arrival and departure dates, last and next ports of call, and total reported BW discharge or uptake only. The particular visit berth or terminal was not recorded.

<sup>5</sup> A CD-ROM version of the 2001 *Lloyds Ship Register* was supplied to each Demonstration Site by PCU. These are much faster to use than the large ‘directory style’ hard-copy volumes.

Gaps in the 2000-2001 spreadsheets, entered BWRF records and the additional Pir Pau/Butcher Island records supplied by MPT were therefore filled by checking, for each arrival, its name, type and DWT, its last port/s of call and apparent charter/liner trade, and by using a customised Excel spreadsheet supplied by the consultants to estimate the amount BW discharged or taken up<sup>6</sup> (Figure 5). This was not possible for the majority of vessels arriving at the break-bulk and general cargo berths in the MPT docks or transferring cargo between vessels or barges in the ‘bundlers’ (MPTs anchorages), with the number of sufficiently completed BWRFs enabling a database record restricted to 531.

These record checking and gap-filling exercises were undertaken by the consultants in July and October 2002 (in Australia), in November 2002 (by Group B and C members during the second visit), and in January 2003 (before the wrap-up visit). In summary, the present (February 2003) database for Mumbai-JNP was constructed by:

- entering visit details from the spreadsheets, port shipping records and BWRFs, using the *Fairplay Port Guide* and *Lloyds Ship Register* to add or correct port details, vessel name, IMO number, type and DWT; plus
- cross-checking unusual or incomplete entries using port shipping records (for JNPT visits only), plus the *Lloyds Ship Register*, *Fairplay Port Guide* and the customised Excel spreadsheet to correct illogical or missing BW discharges, sources or dates.

This Excel spreadsheet can be used to estimate BW discharged by ships when Ballast Water Report Form is unavailable, incomplete or incorrect. [Examples are provided in Rows 1-4; use next available row for checking any ship which did not submit or complete BWRF correctly]

NB: You can customise the BW coefficients (in Worksheet 2) to represent the average percentage discharged by each ship type at your port, by using data from reliable BWRFs (see Worksheet 2: "BW Coefficients").

File / Port Record ID No	Information obtained from Port Shipping Records and				Lloyds Register (IMO Number)		1>Loading 2:Unloading 3:Both			Add from Lloyds Register		Ship Type Code	BW coeff. for:			Estimated Discharge (tonnes)	
	Arrival Date	Ship Name	IMO Number	Cross check GT / Call Siga	Last Country	Last Port of Call	Next Port of Call	Discharge reported	Berth / Location	DWT	Vessel Type		Loadin g	Unloadin g	Both		
1	29-Jan-99	Osam	4687730	-	Bulgaria	Kostanza	Tischar	No record	POL2	1	15,000	Crude oil tanker	A13A	35.0%	0.0%	3.2%	5,250
2	02-Feb-99	Burdur	7777777	-	Turkey	Istanbul	Marseilles	?	B6	3	18,610	Container ship	A33A	15.0%	0.0%	1.0%	186
3	03-Mar-99	Osam	4687730	-	Bulgaria	Tischar	Kostanza	1,200	POL1	2	75,275	Crude oil tanker	A13A	35.0%	0.0%	3.2%	0
4	17-Jun-99	Bulky Maru	2345677	-	Malta	Malta	Karachi	'Yes'	A2	1	156,000	General bulk carrier	A21A	39.0%	2.0%	5.0%	60,840
5																	?
6																	?
7																	?
8																	?
9																	?
10																	?
11																	?
12																	?
13																	?
14																	?

Figure 5. Working page of the Excel spreadsheet used to estimate BW discharges

### 3.5 Identification of destination ports

Since ‘prevention is better than cure’, it is usually most effective to address environmental problems as close to their source as possible. In the case of ballast-mediated aquatic bio-invasions, actions helping prevent ships taking up harmful organisms from ballasting areas may be more effective than trying to treat the organisms once they are inside the tanks, or trying to manage the problem at the discharge port. To date, however, the majority of actions addressing ballast-mediated introductions have been driven and undertaken by ports and port States that receive BW, with little activity occurring at the locations of BW uptake. The GloBallast programme has therefore been attempting to shift some of the focus from shipboard/point-of-discharge measures towards reducing the uptake of organisms in the first place.

Knowing the destinations where departing vessels will discharge BW is an important step in helping port States to reduce the spread of unwanted and potentially harmful species (either introduced or native to their own ports) to their trading partners. It is also critical for preventing unwanted species

<sup>6</sup> The BW spreadsheet contains coefficients of ballast water taken up or discharged when loading or discharging cargo (as percentages of DWT for each vessel type), based on ballast water capacity and discharge data from other studies, BWRFs and *Lloyds Ship Register*.

translocations between a State's domestic ports and/or its neighbouring foreign ports. Determining the destinations of BW exported from the Demonstration Site was therefore an objective of the GloBallast BWRA (Section 2).

Both the BWRFs and port shipping records for Mumbai-JNP list the *Next Port of Call* of all departing vessels, and these were added to the database for analysis. However the next port of call may not be where BW carried by a departing ship is discharged, either fully or partly. For example, the next port may be a bunkering, crew-change or maintenance port, a port where a 'top-up' or other minor cargo is loaded, or a convenient 'hub' port where ships anchor and wait for new sailing instructions. A problem specific to the Mumbai-JNP Demonstration Site stemmed from not uncommon movements of container vessels, general cargo ships and bulk carriers between these two ports, and hence the declaration of either Mumbai or JNP as being the 'Next' or 'Last' port of call on their BWRFs collected by MPT or JNPT. Since the Database treats Mumbai-JNP as a single port (allocated to the UN Port Code INBOM), such records did not provide any clue as to BW sources or destinations. This problem was solvable for arrivals to JNP owing to the accessibility of its computerised port shipping records, unlike the case for Mumbai where less sophisticated, paper reliant record systems provided no ready 'look-up' capabilities (Section 4.3).

To overcome this problem, a supplementary question needs to be added to the present IMO BWRF, i.e. requesting the name of the port where discharge from each ballast tank is predicted. These ports can be predicted by ships engaged on a regular liner service (e.g. most container ships, vehicle carriers, Ro-Ro ships, LNG carriers and some bulk carriers). However for other ship types (and occasionally the former) ship officers cannot reliably anticipate where BW discharges will be necessary. For example, for bulk carriers, general cargo ships and tankers engaged in spot charter work (or when completing a charter period), these vessels may often depart in ballast having a received a general sailing order to proceed towards a strategic location until further instructions.

In the case of Mumbai-JNP, there is considerable importation of coal, iron ore, timber and other raw commodities requiring visiting general cargo ships and bulk carriers to uplift ballast water whilst unloading to maintain trim, stability and in some cases air draft (i.e. space between the hatch coamings and gantries). The next ports of call were therefore added to the vessel visit data and examined, so that the Pilot Country team could gain experience and appreciate the problem of identifying ballast water destinations.

Adding the next port of call also improves the trading history for each vessel, and these can be useful when trouble-shooting missing or incorrect BWRF data. As with the source ports, any new next port of call added to the database was provided with its country name, UN Port Code, world bioregion and location coordinates to enable its frequency of use by departing vessels to be displayed on the GIS world map (port input details are in the GloBallast *BWRA User Guide*).

### 3.6 BWRF database

The Access database developed by the consultants manages all items on the IMO standard BWRF. Entry, editing and management of the BWRF records are undertaken using a series of GUIs, as described in Section 2 of the *BWRA User Guide*. The three 'tab' pages of the GUI used for general BWRF data and the individual ballast tank inputs are shown in Figure 6.

Items not listed on the BWRF but required by the database to run the risk analysis and display the results on the GIS include the geographic coordinates, bioregion and UN code (a unique five letter identifier) of every source and destination port, plus the DWT and berthing location of every arrival at the Demonstration Site.

Many berthing locations had to be identified from the port shipping records because the BWRA objectives include identifying the locations *within* a Demonstration Site where deballasting/ballasting occurs (Section 2). This was not insurmountable at JNP owing to the discreteness of its berthing

terminals and usually the existence of a berth record for recorded BWRFs. In the case of MPT's three docks, however, visit records did not distinguish individual berths or docks and there was no accessible information allowing convenient separation (Section 4.3).

Another item frequently requiring look-up was the vessel's deadweight tonnage (DWT) since the BWRF requests only the gross tonnage (GT). As noted in Section 3.4, adding the DWT (present in the *Lloyds Ship Register*) enables convenient checks of reported volumes and gap-filling of missing values (see below).

Not all of the BWRF question fields need to be completed by a ship's officer to provide a visit record that can be saved to the database and later included in the risk analysis. A basic visit record can be established if three key items are entered. These are outlined in red on the input GUIs (Figure 6) and are:

- Vessel identification - a unique 7 digit IMO number that remains the same for the life of the ship, irrespective of any name changes;
- Arrival date; and
- A ballast tank code (which appears on the 'Add Tank' sheet and provides an 'All Tanks' option for BWRFs that were submitted without individual tank details).

Without these items the database cannot save a vessel visit / tank record or any other associated information. Whether or not a saved record is included by the database for the risk analysis depends on which other BWRF fields were completed or gap-filled. Key items are the source port and volume for each (or all) ballast tanks discharged, and the berthing location. As described in Sections 3.4 and 3.5, important BWRF information that is missing or incorrect can usually be substituted or corrected by cross-checking with port shipping records, the *Lloyds Ship Register* and a comprehensive port directory such as the *Fairplay* guide. However this is very time-consuming and, if there are no convenient 'look-up' features offered by the port's shipping record system, impractical. It is far more efficient and reliable for port officers to ensure the BWRF has been filled in correctly and completely at the time of submission, and to annotate the berth on this form prior to its dispatch to record keepers/database entry (Section 4.10).

The Access database contains reference tables to hold the checked details of every vessel and port previously added. A new visit record is therefore made by entering the arrival date then using a series of drop-down lists to select the vessel, source port, last port, next port, destination port and tank details (Figure 6). This avoids the need to re-enter the same information over and over again, as well as the risk of generating false, 'replicate' vessel, port or tank names due to spelling mistakes on the BWRF.

Spelling mistakes on BWRFs were very common. All data-entry and database managers therefore need to understand how to avoid transcribing such errors by carefully checking all names and ID numbers using the database drop-down lists and, where necessary, by referring to a reliable ship registry or port directory when entering the details of a new vessel or port respectively.

The most easily-trained and efficient database operators are those with previous port and maritime experience since they (a) bring knowledge of the local shipping trade, (b) are familiar with the problems of searching for vessel names (e.g. *Tokyo Maru 2*, *Tokyo Maru II*, *Tokyo Maru No. 11* etc), and (c) are aware that the official name of many ports in Europe, Africa and South America may be quite different from the English name (e.g. Vlissingen versus Flushing).

The figure displays three sequential screenshots of the 'Ballast Water Reporting Form' GUI, each showing a different tab selected in the top navigation bar: 'Vessel Information', 'Ballast Water Tanks', and 'Ballast Water History'.

**1. Vessel Information**  
 This tab contains fields for vessel details: IMO Number (with a 'Last Visit' button), Vessel Name, Type, DWT, Owner, GT, Flag, and Call Sign. It also includes 'Port Information' for Arrival, Last, and Next ports, each with Country and Port dropdowns, and a 'Set as default' checkbox. An 'Arrival' section has Date (dd/mm/yyyy) and Shipping Agent fields. 'Add New Vessel...' and 'Add New Port...' buttons are at the bottom.

**2. Ballast Water**  
 This tab is divided into 'Ballast Control Actions' and 'Ballast Water Tanks'. The 'Ballast Control Actions' section includes a 'Specify units' dropdown, input fields for 'Total ballast water on board' and 'Total ballast water capacity', and a large text area for 'If exchanges were not conducted, state other control action(s) taken:'. Below this is another text area for 'If none, state reason why not:'. The 'Ballast Water Tanks' section has checkboxes for 'Ballast water management plan on board?' and 'Has this been implemented?', and input fields for 'Total No. of tanks on board', 'No. of tanks in ballast', 'No. of tanks exchanged', and 'No. of tanks not exchanged'. The '5. IMO Ballast Guidelines' section includes a checkbox for 'IMO Ballast Guidelines on board (Res. A868(20))?' and a 'Responsible Officer' dropdown.

**4. Ballast Water History**  
 This tab features a table for recording deballasted tanks. The table has columns: Tank Code, Source Date, Source Port, Source Latitude, Source Longitude, and Source Volume. Below the table are 'Add Tank...', 'Remove Tank', and 'Save Visit Details' buttons.

Figure 6. The three tabs of the GUI used for entering the BWRf data

### 3.7 Environmental parameters

During the briefing meetings in January 2002, the consultants provided a preliminary list of environmental parameters that would be used to generate the environmental matching coefficients between the Demonstration Sites and their main BW source ports and destination ports (Appendix 3).

The provisional list was based on review of previous port-to-port environmental analyses undertaken for twelve trading ports in northeast Australia (Hilliard *et al.* 1997b). The final list of 34 parameters used for the six Pilot Countries (Table 1) was selected in February 2002, during a joint review of the provisional list by the consultants and scientists of the Institute of Biology of the Southern Seas (IBSS) in Odessa<sup>7</sup>.

**Table 1. Port environmental parameters used by the Environmental Similarity Analysis**

	<b>Name</b>	<b>Variable Type</b>
1.	Port type <sup>8</sup>	Categorical (1-6)
2.	Mean water temperature during warmest season (°C)	Scalable
3.	Maximum water temperature at warmest time of year (°C)	“
4.	Mean water temperature during coolest season (°C)	“
5.	Minimum water temperature at coolest time of year (°C)	“
6.	Mean day-time air temperature recorded in warmest season (°C)	“
7.	Maximum day-time air temperature recorded in warmest season (°C)	“
8.	Mean night-time air temperature recorded in coolest season(°C)	“
9.	Minimum night-time air temperature recorded in coolest season (°C)	“
10.	Mean water salinity during wettest period of the year (ppt)	“
11.	Lowest water salinity at wettest time of the year (ppt)	“
12.	Mean water salinity during driest period of year (ppt).	“
13.	Maximum water salinity at driest time of year (ppt).	“
14.	Mean spring tidal range (metres)	“
15.	Mean neap tidal Range (metres)	“
16.	Total rainfall during driest 6 months (millimetres)	“
17.	Total rainfall during wettest 6 months (millimetres)	“
18.	Fewest months accounting for 75% of total annual rainfall	Integer
19.	Distance to nearest river mouth (kilometres; negative value if upstream)	Scalable
20.	Catchment size of nearest river with significant flow (square kilometres)	“
<u>Logarithmic distance categories (0-5): From the closest BW discharge location to nearest:</u>		
21.	Smooth artificial wall	Categorical
22.	Rocky artificial wall	“
23.	Wooden pilings	“
24.	High tide salt marsh/lagoon, saline flats or sabkah	“
25.	Sand beach	“
26.	Shingle, stony or cobble beach	“
27.	Low tide mud flat	“
28.	Mangrove fringe/mangrove forest	“
29.	Natural rocky shore or cliff	“
30.	Subtidal firm sandy sediments	“
31.	Subtidal soft muddy sediments	“
32.	Seagrass meadow <sup>9</sup>	“
33.	Rocky reef or pavement	“
34.	Coral reef (with carbonate framework)	“

The 34 parameters were steadily collated during course of BWRA activities for all Demonstration Sites. They were taken or derived from data and information culled from a wide range of government, port and scientific publications, internet web sites, port survey reports and sampling records, SST and salinity charts, climate databases, atlases, national tide-tables, nautical charts, coastal sensitivity and oil spill habitat maps, oil spill contingency plans, aerial photographs, national habitat databases and local expert advice (Appendix 4). The most difficult to find were reliable water temperature and

<sup>7</sup> Distance categories from the berthing area/s to the nearest rocky artificial wall, smooth artificial wall and wooden artificial substrate were suggested by IBSS as they provide different types of hard port habitat.

<sup>8</sup> Offshore terminal or mooring / Natural bay / Breakwater harbour / Tidal creek / Estuary / River port.

<sup>9</sup> Kelp forest/macroalgae bank was not included but should be considered for future analysis.

salinity data, particularly for identifying the averages, maxima and minima for ports in or near estuaries (Section 3.12).

A preliminary list of frequently recorded BW source ports and destination ports for Mumbai-JNP was made at the end of the first in-country visit in April 2002 (the complete list did not become available until near the end of the second in-country visit; Section 3.1). It was agreed that the environmental parameters for these ports should be sought between the first and second consultants' visits, with the Group C counterparts focussing on important ports in India and the consultants focussing on more distant ports in Asia, Middle East and Europe. To facilitate this task the consultants provided a customised Excel spreadsheet for collating the environmental data, which included guidance and reminder notes plus a format enabling direct export to PRIMER (Section 3.8).

Near the end of the second in-country visit, sufficient port environmental data had been collated to generate environmental matching coefficients for approximately 35% of all ports identified as trading with Mumbai-JNP, with estimates provided for ports where unobtained/incomplete data would have prevented their inclusion in the multivariate similarity analysis (Section 4.6). The percentage of ports with calculated environmental coefficients was subsequently expanded by a gap-filling exercise undertaken by the consultants between 22 December 2002 and 31 January 2003. These were added to the updated BWRA provided at the third meeting in February 2003 (Section 3.1) and reported here.

### 3.8 Environmental similarity analysis

The more a BW receival port is environmentally similar to a BW source port, the greater the chance that organisms discharged with the imported BW can tolerate their new environment and maintain sufficient numbers to grow, reproduce and develop a viable population. Comparing port-to-port environmental similarities therefore provides a relative measure of the risk of organism survival, establishment and potential spread. This is the basis of the 'environmental matching' method, and it facilitates estimating the risk of BW introductions when the range and types of potentially harmful species that could be introduced from a particular source port or its bioregion are poorly known.

A limitation of the environmental matching approach is that several harmful species appear capable of tolerating relatively wide temperature and salinity regimes<sup>10</sup>. As discussed, other risk factors include the frequency of ship visits/BW discharges, the volume of BW discharged, voyage times and ballast tank size and any management measures applied during the voyage. While environmental matching alone does not provide a complete measure of risk, an analysis of 'real world' invasions indicates that if any one factor is to be used alone, environmental matching is probably the best single indicator of risk.

Classic examples include the two-way transfer and relatively rapid spread of harmful and other unwanted species between the Ponto-Caspian and North American watersheds (some via stepping stones in western Europe, and *northern* Australian ports that have extremely high risk factors in terms of frequency and volumes of BW discharges (the very large bulk export ports of Port Headland, Dampier and Hay Point and smaller bulk export ports like Weipa and Abbot Point), but which have not experienced any significant harmful invasions (due to a low environmental matching with their source ports). Conversely, in southern Australia and in particular Tasmania, ports which have relatively low risk factors in terms of frequency and volumes of BW discharges, have been the entry points of the most harmful aquatic bio-invasions (due to a high environmental matching with their source ports).

The environmental distances between Mumbai-JNP and its source and destination ports were determined using a multivariate method in the PRIMER package. Of the various distance measures available in PRIMER, the normalised Euclidean distance is the most appropriate. Normalisation of the various input parameters removes the problem of scale differences, and the method can manage a mix

---

<sup>10</sup> For example, the Asian date mussel (*Musculista senhousia*) has been reported from Vladivostok to Singapore.



of scalable, integer and even categorical values, provided the latter reflect a logical sequence of intensity or distance/location steps. Individual variables cannot be weighted but the predominance of temperature variables (8) and salinity/salinity-related parameters (also 8; see Table 1) ensured they exert a strong influence on the results. Air temperature extrema, rainfall and tidal parameters were included owing to their influence on the survivorship of intertidal and shallow subtidal organisms<sup>11</sup>. The similarity values produced by PRIMER were examined using its clustering and ordination modules, then exported back to the Excel file for conversion into environmental matching coefficients before insertion into the database<sup>12</sup>.

To provide consistent and comparable results, the similarity analysis was conducted on a wide geographical range of ports; i.e. from cold water ports in high latitude areas to warm water ports in tropical regions, as well as from up-river terminals to those located in relatively exposed offshore waters. This avoids the possibility of generating spurious patterns among a set of ports located in neighbouring and/or relatively similar regions. Collating the environmental parameters for the frequent source and destination ports of all six Demonstration Sites into a single Excel spreadsheet achieved this, as well as permitting direct comparisons between the results from these sites<sup>13</sup>.

The Excel file used for collating the port environmental data also contains linked spreadsheets used for their export to PRIMER, as well as for re-importing the results and converting them into environmental matching coefficients. In fact the database can import any type of environment matching value obtained by any method, provided the values are placed in an Excel spreadsheet in the format expected by the database's import feature. Details on the treatment of the environmental variables and the production, checking, conversion and import of the similarity measures are given in the *BWRA User Guide*.

### 3.9 Risk species

One of the BWRA objectives was to identify 'high-risk' species that may be transferred to and/or from the Demonstration Sites (Section 2). The Access database was therefore provided with tables for storing the names, distribution and other information on risk species. For the purposes of the BWRA and its 'first-pass' risk assessment, a risk species was considered to be any introduced, cryptogenic or native species that might pose a threat if transferred from a source port to a Demonstration Site. The taxonomic details, bioregion distribution, native/introduced status and level of threat assigned to a species are also stored in the database and can be displayed for review, edit and update.

The database manages the bioregional locations and status of each entered species using the same bioregions displayed on the GIS world map (Figures 7, 8). This map is used as a backdrop for displaying the source and destination ports and associated BWRA results, and was compiled from a bioregion map provided by the Australian Centre for Research on Introduced marine Pests (CRIMP). The boundaries of some bioregions were subsequently modified according to advice provided by Group C marine scientists in five of the six the Pilot Countries, with careful review of the South Asian boundaries by NIO scientists confirming that no change was necessary for its coastal regions (Figure 7). However the modifications included adding new bioregions for several large river systems to accommodate some important river ports that trade with one or more of the Demonstration Sites. In the case of India, the upstream port of Calcutta may merit inclusion in a bioregion comprising the

---

<sup>11</sup> While ecosystem disturbance, pollution, eutrophication and other impacts on habitats and water quality can increase the 'invasibility' of port environments (particularly for *r*-selected species), these were not included owing to the problem of obtaining reliable measures of their spatial extent and temporal nature at each port.

<sup>12</sup> As described in the *BWRA User Guide*, a simple proportional conversion of the similarity values was made so that each matching coefficient lay between 1 (a perfect environmental match) and 0.01 (least matching), since it is unsafe to assume a port environment can be totally hostile no matter how distant.

<sup>13</sup> The total number of ports with a complete set of environmental parameters obtained by the end of the data collation phase was 357. These were provided to all Demonstration Sites during the third consultant's visit in February-March 2003 and used for this report.

Ganges delta, although these brackish waters annually occupy a large portion of the upper Bay of Bengal (CIO-III bioregion) during the summer monsoon (Figure 7).

The map presently displays 204 discrete bioregions which are coded in similar fashion as those in the IUCN scheme of marine bioregions from which they were derived (Kelleher *et al.* 1995; see Appendix 3 of the GloBallast *BWRA User Guide* for details). Bioregions serve multiple purposes and are required for several reasons. Many marine regions of the world remain poorly surveyed and have a limited marine taxonomy literature. This causes a patchy and essentially artificial distribution of recorded marine species distributions. Few marine species surveys have been undertaken in port environments and there are very few bioregions which contain more than one port that has undertaken a PBBS.

Bioregions represent environmentally similar geographic areas. Thus if a species is found established in one part of a bioregion, there is a good chance it can spread via natural or human-mediated processes to other sites in the same bioregion. A conservative approach was therefore adopted for the GloBallast BWRA, whereby a risk species, if recorded in at least one location of a bioregion, is assumed potentially present at all source ports within the same bioregion. This type of approach will remain necessary until a lot more PBBSs are conducted and published. Because taxonomic analyses of the PBBS samples of the Demonstration Sites had not been completed by the consultants second visits, the reverse stance was adopted for these ports (i.e. it was assumed they did *not* contain any risk species recorded at other location/s in their bioregion).

The corresponding set of bioregions stored in the database has particular sets of risk species assigned to them. The species and associated data added to the database over the course of the Activity were collated from a wide range of sources. These included preliminary lists of organisms found by the recent GloBallast PBBS of Mumbai-JNP (which became available during the second consultants visit). Counterpart and URS members of Group C also investigated the possible existence of introduced species lists held by marine biologists at institutions and agencies in the South Asian region, but none were found.

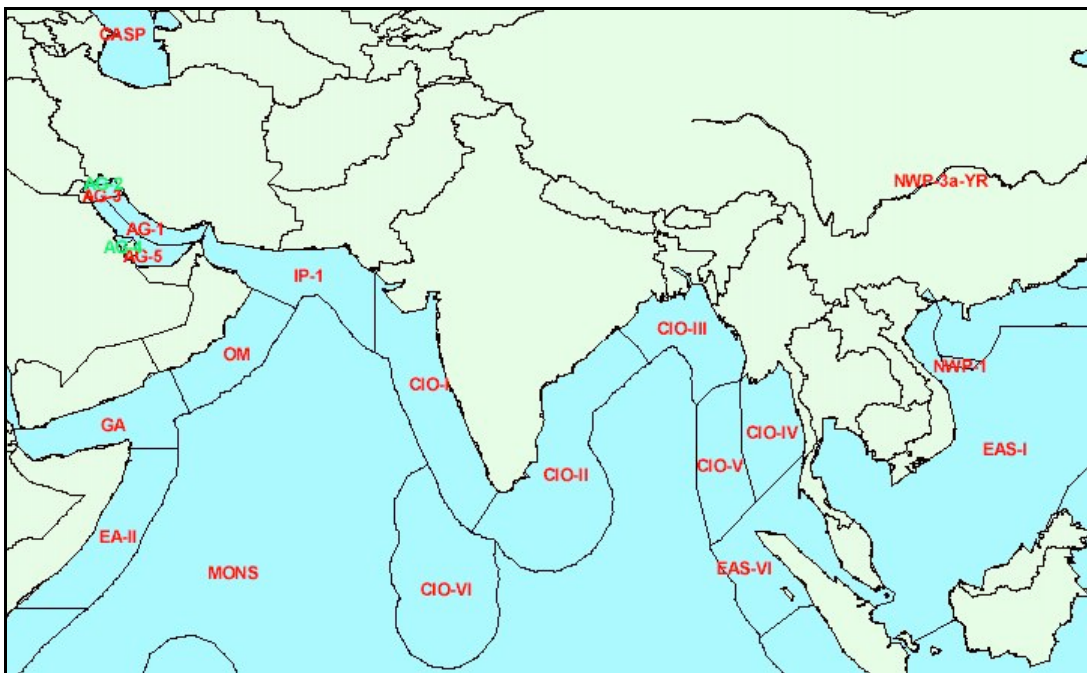

**Figure 7.** Part of the GIS world map of marine bioregions, showing the code names of those in the South Asian region

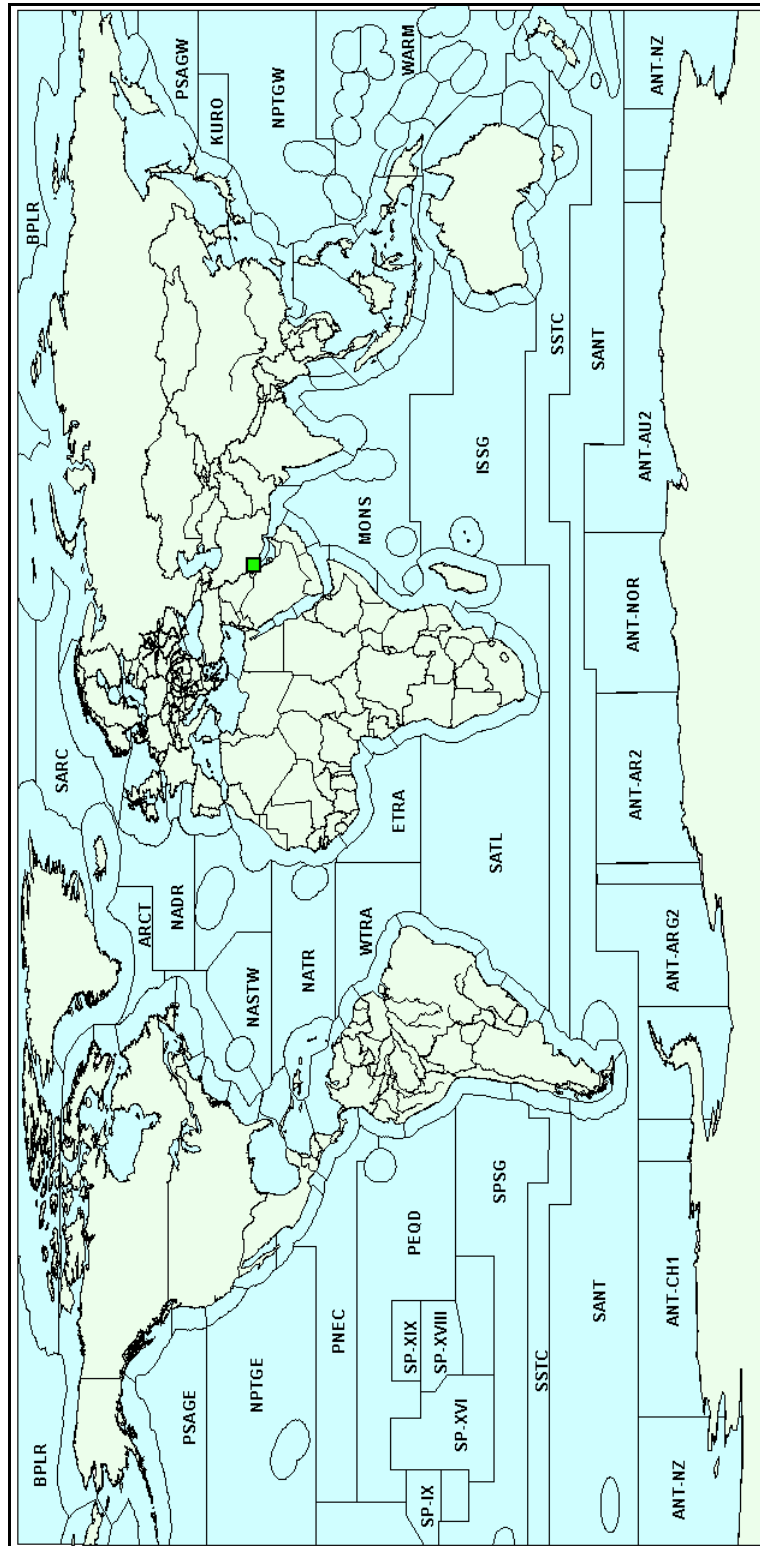

*Figure 8. Complete GIS world map showing the marine bioregions [to improve clarity, not all bioregion codes are shown in this example]*

Sources used for developing the risk species database are listed in Appendix 5 and included a range of literature plus international and regional internet databases, including those being developed by the Smithsonian Environmental Research Center's (SERC) National Estuarine & Marine Invasive Species Information System (NEMISIS), CSIRO's National Introduced Marine Pests Information System (NIMPIS), the Global Invasive Species Programme's (GISP) Global Invasive Species Database, and the Baltic, Nordic and Gulf of Mexico web sites. The database used for the 'first-pass' risk assessments and provided to the Demonstration Sites during the consultants last visit (February 2003) contains 421 species but these do not represent a complete or definitive global list. Thus the database tables and their associated Excel reference file represent a working source and convenient utility of risk species information that can be readily updated and improved.

To provide a measure of the risk species threat posed by each source port, the database analyses the status of each species assigned to each bioregion and generates a set of coefficients that are added to the project-standard calculation of relative overall risk (Section 3.10). The following description is summarised from Section 6 of the *GloBallast BWRA User Guide*, which describes how the species data are managed and used by the BWRA system.

The database allows each species to be assigned to one of three levels of threat, with each level weighted in log rhythmic fashion as follows:

- **Lowest threat level:** This is assigned to species with no special status other than their reported or strongly suspected introduction by BW and/or hull fouling<sup>14</sup> in at least one bioregion (i.e. population/s with demonstrated genetic ability to survive transfer and establish in regions beyond their native range). A fixed weighting (1) is applied to each of these species when present in bioregions outside their native range. This was also the default level assigned to any new species when first added to the database.
- **Intermediate threat level:** This level is assigned to any species suspected to be a harmful species or invasive pest. Risk species assigned to this level receive a default weighting value of 3 in both their native and introduced bioregions.
- **Highest threat level:** This level is assigned to known harmful invasive species, as reported in institutional or government lists of aquatic nuisance species and pests, and/or in peer-reviewed scientific journals. The default weighting value applied to these species is 10.

The database allows users to change the threat status level assigned to each species, as well as the size of the second and third level default weighting values. A third type of risk species weighting option is also available. This can be used to proportionally increase the weight of all source port threat coefficients by increasing its default value of 1. The four default values (1, 3, 10 and 1) provided a 'project standard' result to permit unbiased comparisons between the 'first-pass' BWRA results for each Demonstration Site.

The database calculated the coefficient of 'risk species threat' posed by each source port, with each port value representing a proportion of the total risk species threat. The latter was the sum of all weighted risk species assigned to the bioregion of all source ports that export BW to the Demonstration Site. Species assigned to more than one bioregion are summed only once, and the algorithm automatically discounted any species that was native in the Demonstration Site's bioregion. It included any introduced species assigned to the bioregion of the Demonstration Site

---

<sup>14</sup> At the outset of the project, species capable of transfer only by ballast water were planned to be added to the database. However many species may be introduced by hull fouling as well as BW, with the principal vector for many of these remaining unclear. Group C scientists in all Pilot Countries were unanimous in their preference for including all species introduced by ballast water and/or hull fouling in the project standard BWRA database. For future BWRAs a 'vector status' value could be assigned to each species in the database, so that risk assessments could be focussed on either or both of these shipping-mediated vectors.

since, as discussed above, the Demonstration Site was assumed to be free of risk species. This was the default position of the project-standard BWRA<sup>15</sup>.

The risk species coefficient for each source port is therefore calculated by firstly summing the number of non-indigenous species (NIS) in that port's bioregion which have no suspected or known harmful status. This provides a measure of the low level 'weedy' and sometimes cosmopolitan species which, although having no acknowledged harmful status, have proven transfer credentials that could enable their establishment in another port with probably low but nevertheless unpredictable biological or economic consequences. This number is then added to the sums of suspected and known harmful species in the same bioregion (these include any native species identified as such by Group C local scientists). The default calculation for the risk species coefficient for each source port (C) is thus:

$$C_{\text{Source Port}} = (\text{NIS} + [\text{Suspected Harmfuls} \times 3] + [\text{Known Harmfuls} \times 10]) / \text{Total Sum}_{\text{All Source Ports}}$$

The C values lie between 0-1 and represent an objective measure of the relative total species threat, since the only subjective components within the project standard BWRA database were the 'universal' assignments of species to particular levels of threat, plus the weightings attached to these levels. Note that the C values for source ports inside the same bioregion will be the same, and that the Total Sum divisor does not represent all species in the database, but only those assigned to bioregions containing source port/s that actually trade with the Demonstration Site. It should also be noted there are several limitations from incorporating a risk species coefficient into the default calculation of the 'first-pass' BWRAs. These included:

- Use of an incomplete list of species that were assigned to one of the three levels of threat (introductions, suspected harmful species, known invaders).
- Significant knowledge gaps on the global distribution of many native, cryptogenic and introduced species (as a consequence of the limited number of species surveys that remain geographically biased to parts of North America, Europe and Australian/New Zealand).
- Gaps and constraints in the taxonomy and reliable identifications for many aquatic species groups.

Such limitations must be taken into account when considering the weighting of the risk species coefficient relative to the other risk factors such as environmental matching.

### 3.10 Risk assessment

#### *Approach*

The database employed the BW discharge, port environmental matching and bioregion species distribution/threat data to calculate, as objectively as possible, the relative risk of a harmful species introduction to a Demonstration Site, as posed by discharges of BW and associated organisms that had been ballasted at each of its identified source ports. A GUI enabling convenient alteration of the risk calculations and weighting values (Figure 9), plus use of ArcView to geographically display results, improves the system's value as an exploratory utility and demonstration tool.

The semi-quantitative method aims to identify the riskiest tank discharges with respect to a Demonstration Site's present pattern of trade. Unlike a fully quantitative approach, it does not attempt to predict the specific risk posed by each intended tank discharge of individual vessels, nor the level of confidence attached to such predictions. However, by helping a Demonstration Site to determine its riskiest trading routes, exploring the semi-quantitative BWRA provides a coherent method for identifying which BW sources deserve more vessel monitoring and management efforts than others, plus the significance of local, regional and distant trading routes and associated vessel types.

<sup>15</sup> When the taxonomic identifications of the recent port biological baseline surveys are completed, risk species confirmed as already present at a Demonstration Site may be identified for the BWRA database maintained for that site. Their deletion would reduce the size of the risk species coefficients obtained by the 'first-pass' BWRA such as reported here, but the revised database should not be copied for undertaking other port BWRAs.

Factor Description	Factor Formula
Risk Reduction Factor for Max BW Discharge Volume (R1)	IIF([Max BW Volume Discharge Per Tank]<100,0.4,IIF([Max BW Volume Discharge Per Tank]<500,0.6,IIF([Max BW Volume Discharge Per Tank]<1000,0.8,1)))
Risk Reduction Factor for Min BW Storage (R2)	IIF([Min BW Storage (Days)]>50,0.2,IIF([Min BW Storage (Days)]>20,0.4,IIF([Min BW Storage (Days)]>10,0.6,IIF([Min BW Storage (Days)]>5,0.8,1)))
Weight for Suspected Pests	3
Weight for Known Pests	10
Weight for the Risk Species Value	1
Relative Overall Risk Coefficient	[(Percentage of Tank Discharges] + [(Percentage of BW Volume Discharges] * [Tank Vol Size Risk Reduction]) + [(Relative Risk Species Weighting Value] * [Storage Risk Reduction]) + [Env Matching Coefficient)]/4
Risk Category Assessment	IIF([Relative Risk Ratio]<0.2,"5 - Lowest",IIF([Relative Risk Ratio]<0.4,"4 - Low",IIF([Relative Risk Ratio]<0.6,"3 - Medium",IIF([Relative Risk Ratio]<0.8,"2 - High","1 - Highest")))

To restore the default formula for the SELECTED Factor, click this button.

Figure 9. Database GUI used for manipulating the BWRA calculation and weightings

### Risk coefficients and risk reduction factors

For each source port, the database used four coefficients of risk (C1-C4) and two risk reduction factors (R1, R2) to produce a relative overall measure of the risk of a harmful species introduction at the Demonstration Site. The database GUI shown in Figure 9 can be used to remove one or more of these components, or alter the way they are treated, from the default 'project-standard' formula which was used for the first-pass BWRA. The four risk coefficients calculated for each source port were:

- C1 – proportion of the total number of ballast tank discharges made at the Demonstration Site,
- C2 – proportion of the total volume of BW discharged at the Demonstration Site,
- C3 – port-to-port environmental similarity, as expressed by the matching coefficient,
- C4 – source port's contribution to the total risk species threat to the Demonstration Site, as posed by the contemporary pattern of trade (1999-2002).

In biological terms, C1 and C2 represent the frequency and size of organism 'inoculations' respectively. C3 provides a measure of the likely survivability of these inoculated organisms, and C4 the relative threat posed by the organisms within each inoculation. Each coefficient has values between 0-1 except C3, where the lowest value was set to 0.01 (it is unsafe to assume a port environment can be sufficiently hostile to prevent survival/establishment of every transferred introduced species; Section 3.8).

The two risk reduction factors calculated by the database were R1 (effect of ballast tank size on C2) and R2 (effect of tank storage time on C4). R1 represents the effect of tank size on the number and viability of organisms that survive the voyage, since water quality typically deteriorates more rapidly

in small tanks than large tanks (owing to the volume/tank wall ratio and other effects such as more rapid temperature change, with mortality rates generally higher in small tanks). As described below, no risk reduction was applied to any source port dispatching vessels with tank volumes greater than 1000 tonnes.

R2 represents the effect of tank storage time on the range and viability of discharged organisms. Survival of most phytoplankton and aerobic biota inside any tank decreases with time, with relatively high survival rates reported for voyages less than 5 days (as shown below, this was adopted as the cut-off point for any risk reduction due to in-tank mortality). If the focus is only on long-lived anaerobes, dinoflagellate cysts or pathogens (all of which have long tank survival rates), then R2 can be deleted from the BWRA calculation, using the GUI shown in Figure 9 (details are in the GloBallast *BWRA User Guide*).

The database calculates the tank storage time by subtracting the reported tank discharge date from the ballast uptake date. For incomplete BWRFs with missing discharge or uptake dates, the vessel arrival date plus a standard voyage duration at 14 knots<sup>16</sup> were used to estimate the BW uptake date for adding to the database. The database automatically provides values for R1 and R2 using a log rhythmic approach<sup>17</sup>, with the project-standard BWRA applying the following default (but adjustable) R1 and R2 risk-reduction weightings to C2 and C4 respectively:

<b>R1</b>	Maximum tank volume discharged (tonnes) in the database record for each source port	<100	100-500	500-1000	>1000	
W4	Default risk-reduction weighting applied to C2	0.4	0.6	0.8	1	
<b>R2</b>	Minimum tank storage time (days) in the database record for each source port	<5	5-10	10-20	20-50	>50
W5	Default risk-reduction weighting applied to C4	1	0.8	0.6	0.4	0.2

Although all information reported in the ballast tank exchange section of the BWRFs was entered into the database, the 'first-pass' BWRA did not use these data to apply a risk reduction factor for each source port route for the following reasons:

- implementation of the BWRFs at the Demonstration Sites has been relatively recent, and the tank exchange did not provide a sufficiently consistent or reliable sample of ballast importation for most sites (Section 3.4);
- BWRF implementation was generally on a voluntary basis, with no formal mechanism compelling all vessels to submit fully completed forms at Mumbai-JNP;
- insufficient vessel inspection/ tank monitoring data were available for checking claimed exchanges and their locations (often unrecorded);
- discounting whether or not effective exchange/s were taking place (a) removed the need to predict the size of the risk reduction, and (b) was precautionary with respect to the ability of exchanges to remove all organisms taken up at the time of ballasting.

### **BWRA calculation**

As shown in Figure 9 and described in the GloBallast *BWRA User Guide*, the database GUI allows the six components of the BWRA calculation and the five weighting factors to be altered from the default,

<sup>16</sup> The voyage duration between ports for particular vessel speeds are tabled in many maritime guides and atlases, such as the Lloyds *Maritime Atlas of World Ports and Shipping Places* and the 2001 *Fairplay Port Directory*.

<sup>17</sup> As with the risk species threat level weightings, a log rhythmic approach is appropriate for risk reduction factors in biological risk assessments.

‘project-standard’ setting. The GUI can therefore be used to explore how particular risk components and their treatment influence the final result, and also improves the demonstration value of the system. One example is the way the environmental matching coefficient (C3) is treated by the BWRA calculation. For scientists who consider that C3 should be treated as an independent coefficient of risk (see below), then the formula for calculating the relative overall risk (ROR) posed by a source port is:

$$(1) \quad ROR = (C1 + [C2 \times R1_{w4}] + C3 + [C4 \times R2_{w5}]) / 4$$

Equation (1) is the default setting used for the project-standard BWRA for each Demonstration Site. In this case, ROR is the combined measure of the proportional ‘inoculation’ frequency (C1) and size (C2), the relative similarity of the source port/Demonstration Site environmental conditions (C3), and the relative level threat posed by the status of species assigned to the source port’s bioregion (C4). The division by 4 keeps the result in the 0-1 range to allow the convenient expression of the ROR as a ratio or percentage of the total risk posed by all the source ports.

For those who consider the proportional risk species threat (C4) should provide the focal point of the risk calculation, they may prefer to treat C3 as a risk reduction factor for influencing the size of C4, rather than using it as an independent ‘surrogate’ coefficient to help cover unidentified or unknown species. The GUI allows the formula to be changed to reflect this approach, in which case C3 would be applied as follows:

$$(2) \quad ROR = (C1 + [C2 \times R1_{w4}] + [C3 \times C4 \times R2_{w5}]) / 3$$

*[divisor is now 3 because of the reduced number of summed coefficients].*

For a source port in a bioregion with a large number of risk species (eg. a relatively high C4 of 0.2) but with an environment very dissimilar to the Demonstration Site (e.g. C3 = 0.2), then Equation (2) would reduce C4 to 0.04 (i.e. an 80% reduction). If the minimum tank storage time was relatively long (e.g. R2 was between 10-20 days for the quickest voyages, so W5 = 0.6), then C4 would be further reduced to 0.024 (i.e. an 88% reduction to its initial value).

**Table 2. Examples showing how Equation (1) provides more conservative outcomes than (2) for typical situations\***

(*when C1 and C2 are less than 50%)		Relative Overall Risk	Proportion of discharge Frequency	Proportion of discharge Volume	Environmental matching	Relative Risk species threat
		ROR	C1	C2	C3	C4
ROR = [C1 + C2 + C3 + C4] / 4	Equation (1)	0.150	0.1	0.1	0.2	0.2
ROR = [C1 + C2 + (C3 x C4)] / 3	Equation (2)	0.080	0.1	0.1	0.2	0.2
ROR = [C1 + C2 + C3 + C4] / 4	Equation (1)	0.200	0.2	0.2	0.2	0.2
ROR = [C1 + C2 + (C3 x C4)] / 3	Equation (2)	0.147	0.2	0.2	0.2	0.2
ROR = [C1 + C2 + C3 + C4] / 4	Equation (1)	0.350	0.5	0.5	0.2	0.2
ROR = [C1 + C2 + (C3 x C4)] / 3	Equation (2)	0.347	0.5	0.5	0.2	0.2
ROR = [C1 + C2 + C3 + C4] / 4	Equation (1)	0.400	0.6	0.6	0.2	0.2
ROR = [C1 + C2 + (C3 x C4)] / 3	Equation (2)	0.413	0.6	0.6	0.2	0.2
ROR = [C1 + C2 + C3 + C4] / 4	Equation (1)	0.450	0.7	0.7	0.2	0.2
ROR = [C1 + C2 + (C3 x C4)] / 3	Equation (2)	0.480	0.7	0.7	0.2	0.2
ROR = [C1 + C2 + C3 + C4] / 4	Equation (1)	0.550	0.9	0.9	0.2	0.2
ROR = [C1 + C2 + (C3 x C4)] / 3	Equation (2)	0.613	0.9	0.9	0.2	0.2

Equation (2) is logical provided the database contains an accurate distribution of appropriately weighted risk species in the various source port bioregions (including native species considered potentially harmful if they established in other areas). However Equation (2) is less conservative than Equation (1), particularly if there are doubts that C4 provides a true picture of potential risk species threat. As shown in Table 2, Equation (1) produces higher ROR values, unless a single source port accounts for over 50% of the frequency (C1) and volume (C2) of the total discharges at a Demonstration Site (this is highly unlikely). The database also allows users to increase the influence



of C4 on the ROR by increasing the default value of the overall W3 weighting factor from 1 (but see the caution in Section 3.10). Increasing the size of C4 has more affect in Equation (1) because C3 has no direct influence on the size of C4.

### ***Managing and displaying the results***

When the database is requested to calculate the BWRA, it generates a large output table that lists all sources of tank discharges recorded at the Demonstration Site, as entered from the BWRFs and/or derived from the port's shipping records. The table shows the ROR values plus their component coefficients and reduction factors. Because the Demonstration Sites have a large number of source ports (80-160), trends are difficult to see within long columns of tabled values.

The ROR results are therefore further manipulated by the database to provide additional columns showing:

- the risk category of each source port, as placed in one of five levels of risk for displaying on the GIS world map;
- a standardised distribution of the ROR results, i.e. from 1 (highest ROR value) to 0 (lowest value).

The five risk categories are labelled 'highest', 'high', 'moderate', 'low' or 'lowest', with their boundaries set at equal linear intervals along the 0-100% scale of cumulative percentage risk (i.e. at 80%, 60%, 40% and 20% intervals). This is the default setting used for the project-standard BWRA. The database GUI (Figure 9) allows users to shift one or more of these boundaries to any point on the scale. For example, a log-based distribution of the five risk categories may be preferred and is easy to produce using the GUI.

In the case of the standardisation, the database applies the following simple manipulation to expand the distribution of ROR values to occupy the 0-1 range, where 1 represents the maximum ROR value and 0 the minimum value:

$$ROR_{\text{STANDARDISED}} = (ROR - ROR_{\text{MINIMUM}}) \times 1 / (ROR_{\text{MAXIMUM}} - ROR_{\text{MINIMUM}})$$

This facilitates comparisons between BWRA results from other sites, as well as from different treatments of the ROR formula and/or the weightings. As with the ArcView GIS, the database was designed to optimise the user-friendliness, flexibility and management utility of the system.

### ***Rationale for undertaking 'Project Standard' BWRA***

The flexibility provided by the database allows users to investigate and demonstrate various permutations and avenues without requiring specialised knowledge in database construction and editing. However it was important to apply a consistent, straightforward approach to the 'first-pass' BWRA for each Demonstration Site, so their outcomes could be compared and contrasted to help (a) evaluate the system and approach, and (b) identify areas where changes could improve future use.

Each Demonstration Site has a particular trade profile and associated pattern of deballasting/ballasting. Their divergent geographic locations further contributes to their possession of unique sets of BW source ports which have relatively limited overlap. Thus if results from any two or more Demonstration Sites are to be compared, all of their shared and non-shared source ports and bioregions need to be combined for calculating the environmental matching and risk species threat coefficients.

It was therefore decided that, because the six sites effectively span the globe, the 'project-standard' BWRA undertaken for each site should use the same global set of source port environment and risk species data. This ensures the port-to-port similarities and risk species threats were based on the widest possible range of port conditions and species distributions, thereby reducing the potential for spurious results resulting from overly narrow regional approaches (Section 3.8).

### 3.11 Training and capacity building

Members of the consultants team worked with their Indian counterparts to provide BWRA guidance, training, software and associated materials on the following occasions:

<b>Occasion/ Date [working days]</b>	<b>BWA Activity Tasks</b>	<b>Consultants</b>	<b>Location and Counterparts*</b>
Activity Kick-Off January 2002 [1.5 days]	Presentation, briefing and logistics meetings to: Identify equipment and counterpart requirements Develop provisional pilot country visit schedule	R Hilliard	NIO, Goa. CFP / CFPAs from all Pilot Countries
1 <sup>st</sup> Country Visit March 2002 [5 days]	Introductory discussions Install and check computer software Review BWRFs and identify port record locations Commence training and capacity building at DGSO Commence BWRF database development & training Begin GIS mapping of port and resources in NIO Review port environmental data and sources in NIO Seminar on multivariate similarity analysis at NIO Identify data collation/input tasks before 2 <sup>nd</sup> visit End of visit logistics meeting at DGSO.	R Healy T Hayes R Hilliard	DGS Mumbai; JNP Sheva Is.; NIO, Goa  Group A counterparts Group B counterparts Group C counterparts
2 <sup>nd</sup> Country Visit November 2002 [12 days]	Update Database GUIs, add-ins & make ODBC links Port tour of Mumbai and JNP provided by MPT-JNPT Complete GIS mapping of port and resources at NIO Collate and enter port shipping records from JNPT Locate Butcher Point oil terminal shipping records. Further BWRF database instruction at DGSO Continued guidance and capacity building at NIO Port environmental data assembly and input at NIO Complete environmental similarity analysis training Generate environmental matching coefficients at NIO Review bioregions and add species data to database. Complete NIO training with initial BW risk analysis Hold seminar at DGSO to review BWRA activity and discuss initial results. Discuss pilot country needs at DGSO for future BWRA	C Clarke T Hayes R Hilliard	DGS Mumbai; JNP Sheva Is; NIO, Goa.  Group A counterparts Group B counterparts Group C counterparts
3 <sup>rd</sup> 'Wrap-up' Visit February 2003 [2 days]	Provide database containing all port environmental and risk species data obtained for the six Demo Sites Provide updated <i>BWRA User Guide</i> and final training on BWRA system operation Review and discuss updated BWRA results.	C Clarke	DGS Mumbai; CFP India Group B leader Group C leader

\* refer Appendix 2 for project team structure and counterpart details.

At the kick-off meeting in January 2001, CFP/CFPAs were briefed on the nature, objectives and requirements of the activity. An introductory PowerPoint presentation describing the BWRA system proposed for achieving the BWRF objectives was made, and logistics meetings with individual Pilot Countries subsequently held. A project check-list and briefing document were distributed listing the computer hardware and peripherals required at each Demonstration Site plus the proposed structure of the joint Pilot Country-consultants project team (see Appendices 2 and 3). Appropriate experience of Pilot Country counterparts for the three groups forming the team was emphasised during the kick-off meetings.

During the subsequent in-country visits by the consultants, the main BWRA training and capacity-building components provided to Pilot Country counterparts were as follows:

- Supply of software licences and User Guide and installation of ESRI ArcView 3.2 and PRIMER 5.
- Guidance for GIS port mapping of marine resources and habitats.
- Supply of 2001 CD-ROM edition of the *Lloyds Ship Register* (direct from PCU) and a customised Excel spreadsheet file for convenient collation of vessel identification and DWT data and reliable estimation of BW discharges from port shipping records (for the pre-BWRF period and BWRF checking).
- Guidance, ‘hands-on’ training and assistance with the Access database and BWRF management<sup>18</sup>,
- Guidance, ‘hands-on’ training and glossaries of terminology on the collation, checking, gap-filling and computerisation of BWRFs and principles of database management.
- Guidance and assistance on (a) search, collation and computer entry of environmental data for important BW source and destination ports, and (b) the terminology, networking, data collation and management requirements for species information used for the risk species threat coefficient.
- Tutorial, ‘hands-on’ training and assistance on theory, requirements and mechanics of multivariate similarity analyses of port and coastal environmental data.
- Tutorial, guidance, ‘hands-on’ training, seminars and PowerPoint material on BWRA approaches, methods and results evaluation.
- Supply of electronic *BWRA User Guide* with glossaries and technical appendices.

To promote collaboration, understanding and continuity among the three groups, the consultants arranged for group counterparts to provide presentations and guidance to other group members during the 2<sup>nd</sup> visit. This was achieved for Groups A and C at the NIO offices in Goa during the second visit, with inter-group presentations involving Pilot Country counterparts in Group B and Group C being limited to the Seminar held at the end of this visit at the DGS offices in Mumbai.

---

<sup>18</sup> As noted in Section 3.1, there was a lack of Group B counterparts to support the CFP-A (Group B leader) in Mumbai following the consultants first visit. The consultants therefore provided ‘distance-support’ between visits for database updates and port shipping record spreadsheet data sent from CFP-A. This resulted in the consultants receiving thirteen separate databases, each containing different groups of visit records (some repeated) plus various new and often replicated entries for new vessel details and port names. The vessel, port, visit record and BW tank records in these individual databases were therefore extracted, sorted, checked as much as possible without access to shipping records (i.e. ship and port details added/corrected) and then recombined by the consultants to produce a single, more coherent single database by the start of the second visit. Visit records from MPT terminals were still insufficient, however, and much port record checking at JNPT was also required to gap-fill and confirm which records were actually Mumbai or JNP terminal visits. Much of the Group B consultant’s effort in the second visit was therefore diverted towards record clarification plus sourcing more visit records for Mumbai. Group C also provided support during the second visit for sourcing visit records for the Butcher Island terminals, and subsequently gap-filling these to allow database entries.

### 3.12 Identification of information gaps

This was a critical part of the activities undertaken during the first in-country visit by the consultants, with attention focussed on locating and checking the following BWRA data-input components:

- Completeness of BWRFs submitted by vessels arriving at the Demonstration Site.
- Gaps, legibility and authenticity of information reported in returned BWRFs.
- Sources and availability of port shipping records for BWRF checking and gap-filling.
- Existence of electronic and paper charts, topographic and coastal resource maps, atlases, aerial photographs and publications for GIS port map.
- Sources, reliability and extent of port environmental data and coastal resource information for Demonstration Site and its trading ports in the Pilot Country and region.
- Sources and extent of marine species records, information and researchers on introduced species in and near the Pilot Country.

At the end of the first country visit, the status of the above were reviewed and a list of gap-filling tasks, as allocated to the Pilot Country groups or consultants and to be undertaken by the second visit, were agreed upon and minuted. Extensive follow-up database sort-out, expansion and gap-filling tasks were subsequently conducted before, during and after the consultants second visit.

## 4 Results

### 4.1 Description of port

#### **General features**

The Ports of Mumbai and Jawaharlal Nehru (Mumbai-JNP) are located on the north-west Indian coast close to 18° 54' N and 72° 49' E (Figures 2, 7, 11). The neighbouring ports are located on either sides of the wide, long entrance channel to Thane Creek, which encapsulates the greater city area of Mumbai. This generally narrow and part-mangrove lined tidal channel delineates Mumbai (Bombay) Island from the mainland, and is linked to various creeks and coastal drainages, including the Amba River (see Section 4.2 for coastal habitat details).

After entering Mumbai's inshore waters near Colāba Point, ships collect a pilot and follow the dredged Main Channel (maintained depth ~11.0 m below chart datum) which leads to the short inner approaches that connect with the various Mumbai and JNP berthing areas (Figure 11). Because of the relatively large tide range (3.6 m and 1.4 in springs and neaps respectively), vessels up to 12.5 m in draft may undertake tidally-assisted arrivals or departures.

#### **Climate and weather**

The humid tropical climate of the Mumbai-JNP region comprises hot, humid summers with cooler and drier winters. The summer (south west) monsoon which influences the Mumbai region occurs during June-September. Day-time temperatures regularly exceed 29°C during summer (typical maxima to +36°C), while night-time temperatures can fall below 24°C in winter (typical lowest minima 19°C). Over 75% of the high annual average rainfall (2246 mm) falls during the two months of the summer monsoon. An annual wind rose showing the dominance of easterly and south-westerly components of the prevailing winds in the area is shown in Figure 10.

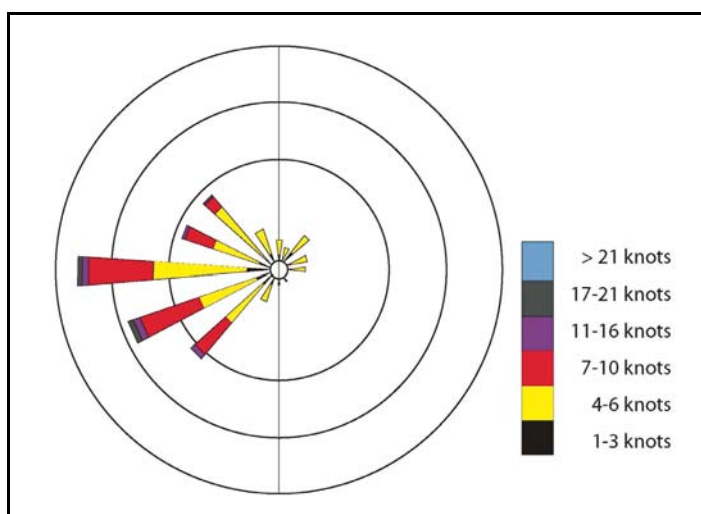

**Figure 10.** Annual wind rose typical of the Mumbai region

#### **Hydrodynamic conditions**

Tidal currents in the port channel areas regularly exceed 3 knots owing to the moderate tidal range, which is close to 3.6 m during springs and 1.4 m during neaps. Strongest tidal flows follow the direction of the central channel, i.e. to the east and north-east during the flood tide and to the south-west and west during the ebb tide. No hydrodynamic modelling study providing a water movement

plot for Mumbai and JNP could be located by Group A for incorporating or linking to the GIS Port Map<sup>19</sup>.

### ***Port facilities and maintenance***

The city docks and other terminals on the west and north sides of the navigation channel are managed by the MPT, while the container, bulk and multi-use berths located on the east side (i.e. on the Nhava Sheva Islands) are managed by the JNPT. The various Mumbai-JNP approach channels and berthing areas are maintained by regular dredging, and are shown in Figure 11 and described below. Figure 11 also shows the spoil grounds, port limits and anchorages (frequently used for transhipments), plus Mumbai's large Naval anchorage and port to the south of the city.

The Port of Mumbai (UN Port Code INBOM) contains the following docks and jetty terminals, as ordered from north to south (Figure 11):

#### ***Pir Pau petrochemical jetties***

- Pir Pau old jetty: 1 petrochemicals berth (7.5 m).
- Pir Pau new jetty: 1 petrochemicals berth (12 m).

#### ***Butcher Island oil terminals***

- Jawahar Dweep: Nos 1-3 products and crude import/export berths (11 - 11.6 m).
- Jawahar Dweep: No. 4 crude oil import and export berth (14.6 m).

#### ***City Docks***

- Prince's Dock: 8 multi-purpose berths (6 – 6.4 m).
- Victoria Dock: 14 multi-purpose berths (6 - 6.7 m).
- Indira Dock: 27 multi-purpose, container, grain and heavy-lift berths (8 - 9.2 m).
- Ballard Pier: 1 container berth (10 m) and 1 passenger/cargo berth (10 m).

#### ***Transshipment anchorages for barge-ship/ship-ship container and other cargo exports/imports***

- Bunders: Various anchorage points on the north side of the Main Channel (7-10 m).

The modern Port of Jawaharlal Nehru (UN Port Code INNSA) was developed at Nhava Sheva and commissioned in 1989. It has continued to develop rapidly and contains the following facilities and berths (from north to south):

#### ***Transshipment anchorage for barge-ship/ship-ship cargo transfers (mostly bagged/dry bulk cargo; 11 m)***

- Nhava Base: Handles the supply vessels supporting the offshore Bombay High oil fields (approximately 1800 vessel movements per year)

#### ***Container Terminal***

- NSICT: 2 berths (13.5 m)
- JNP CT: 3 berths (13.5 m)

---

<sup>19</sup> It is possible one or more useful plots may be present in: V. Abral (1990). Numerical modelling of tidal circulation and tide induced water level variation in Bombay Harbour. *Indian Journal of Marine Sciences* 10, 89-94.

### Bulk terminal

- Ro-Ro/multi-purpose: 1 multi-use berth for Ro-Ro, liquid bulk (incl. naphtha) and general cargo (13.5 m)
- Dry bulk: 1 dry bulk berth (13.5 m)
- BPCL terminal: 2 chemical berths recently commissioned for liquid bulk cargos (13.5 m)

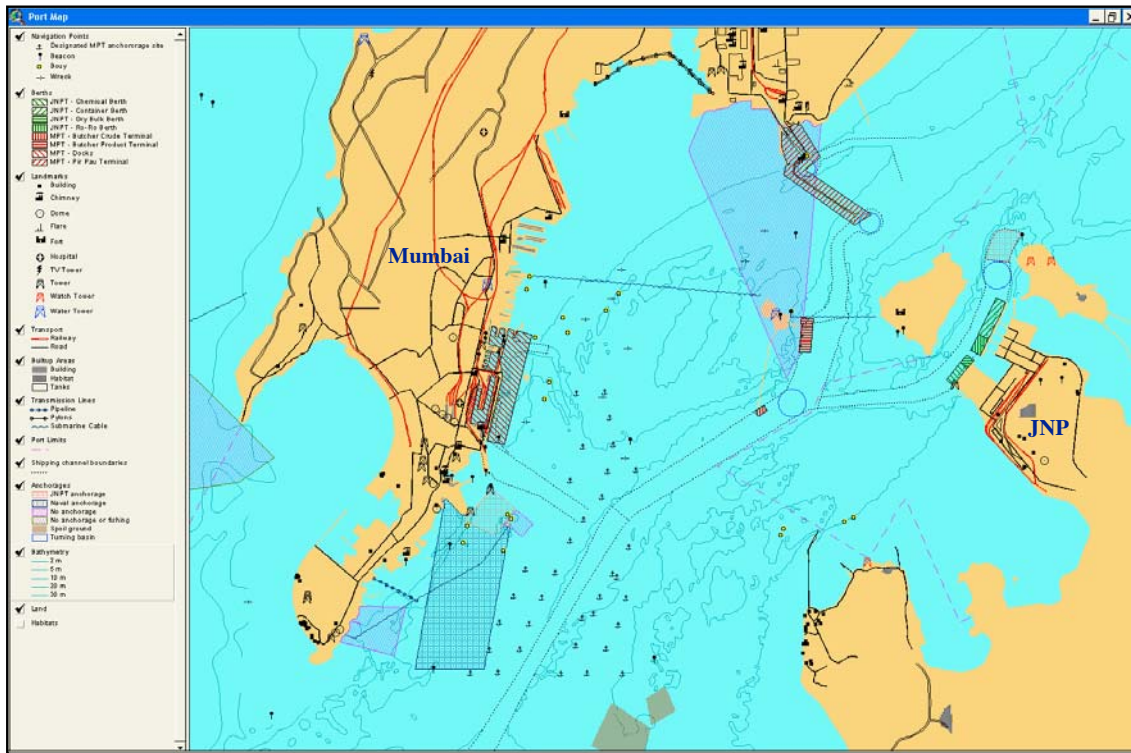

Figure 11. Part of the GIS Port Map showing the navigation, infrastructure and active berth layers for the ports of Mumbai and JNP.

## 4.2 Resource mapping

The subtidal seafloor habitats in the Mumbai-JNP region are dominated by soft muddy sediments, and they are shown on the GIS Port Map (Figure 12). There are no major seagrass, seaweed beds in the estuarine port area owing to the turbidity, depth and reduced salinities during the seasonal monsoons, nor any coral reefs in the region. The intertidal habitats comprise the following:

- Artificial rocky walls along the dock breakwaters and bounding various reclaimed, heightened and stabilised shorelines at JNP and other parts of the Trombay Channel;
- High tidal salt pan areas;
- Rocky and stony shores around some of the islands and points;
- Extensive areas of intertidal muddy shores;
- Mid-to-high tidal fringes of mangrove forest;
- Sand beaches and spits (most developed in Dharamtar Creek to the south-east).

There are no gazetted fishery reserves or wildlife breeding areas in the Mumbai-JNP region, while artesanal fishing and netting is practised at various informal sites in the area. It was decided not to show the location of abandoned fish traps as this would be misleading as to current locations of fishing activity.

The GIS port map show the locations of the Port Biological Baseline Survey (PBBS) sampling sites on a separate layer (Figure 11), so that the final results from each site can be readily added from the final PBBS report. The GIS port map also depicts all the deltaic tidal channels plus the main navigational and urban/developed features near the port, including railways and roads (Figure 11).

Because of the scale of the map and the extent of the urbanised and other developed areas in the Mumbai-JNP region, individual features such as post offices, places of worship or radio masts were not added. The fort and historic Hindu temple on Elephanta Island was added as this remains a significant pilgrimage site in the greater harbour of Mumbai-JNP. Wreck-sites were also added, although none could be identified as having significant archaeological or cultural-heritage value.

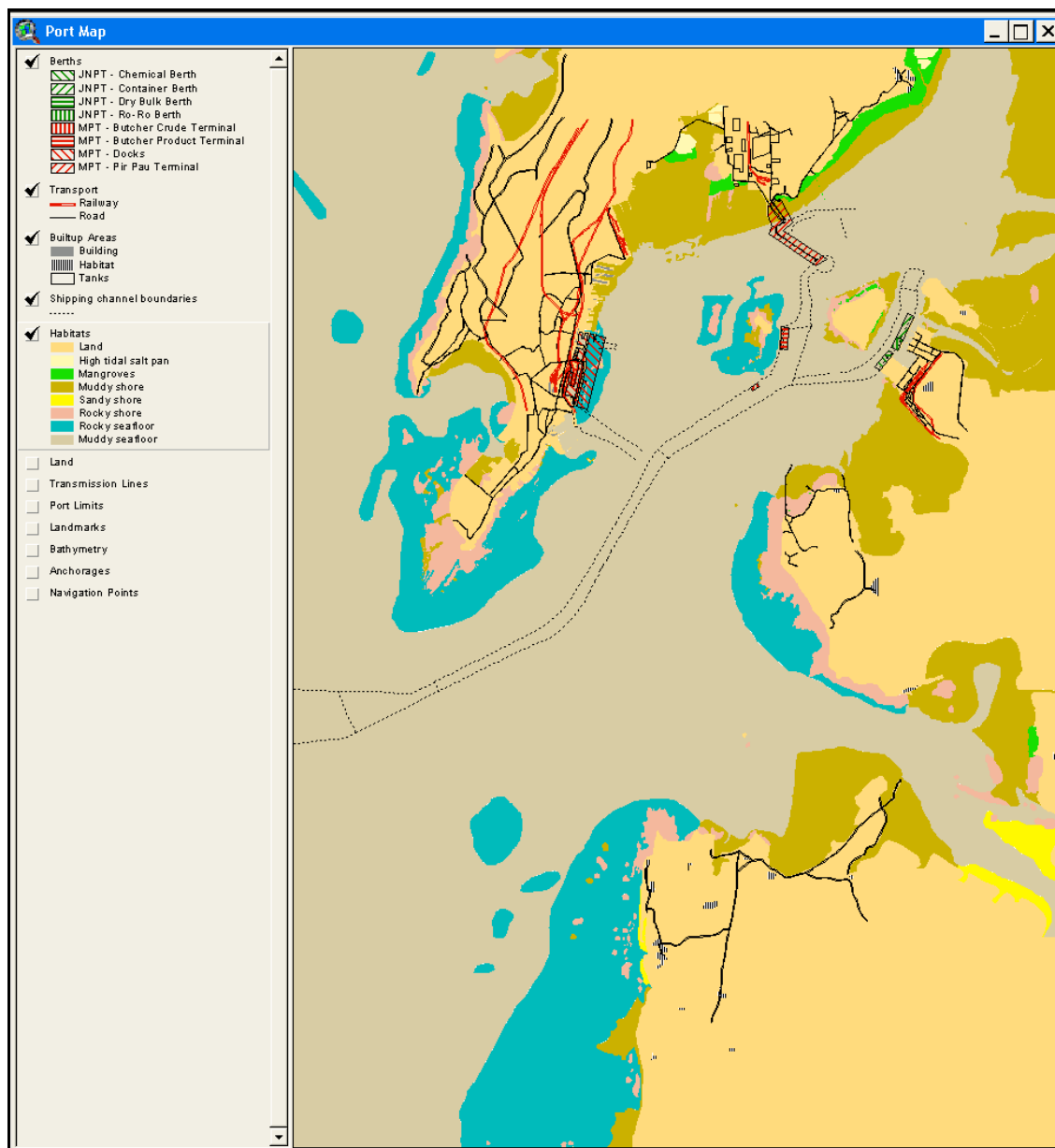

**Figure 12.** Part of the GIS Port Map showing the active berth and marine habitat layers.



### 4.3 De-ballasting/ballasting patterns

During meetings with the MPT and JNPT dock masters in March and November 2002, the navigational rules and deballasting/ ballasting practises of arriving vessels were discussed. Pilotage is compulsory, with boarding occurring near the entrance to the Main Channel. Once entering sheltered water, any cargo-empty vessel arriving during a heavy swell period (most common in the summer monsoon) is allowed to release any 'heavy weather' ballast it may have taken up in the open ocean to improve stability. However this is rare and probably occurs only for empty products tankers going to Butcher Island. As in other ports, the port and pilotage rules require all empty ships to retain sufficient ballast on board to maintain adequate propulsion and steering control, and to minimise windage until berthing is completed. Windage is typically most consistent and significant in the June-July monsoonal season.

It was difficult to establish an overall picture of deballasting/ballasting patterns for Mumbai-JNP because of the large number terminals, transshipment points and berths, many of which are multi-purpose (for break-bulk, palleted, bulk grain, metals, scrap, vegetable oil, containers, Ro-Ro and other cargos), and the difficulty of accessing port shipping records and previously collected BWRFs. For example, during the first visit it was agreed to source copies of MPT's FoxPro files of its port shipping records but these were not available, neither were BWRFs that had been previously collected and entered but unfortunately not archived by DGS.

Many of the general cargo ships, smaller bulk carriers, container vessels and Ro-Ro vessels do not arrive fully loaded, and with some or all their cargo on board destined for:

- unloading (i.e. possible ballast water uptake),
- retention on board (i.e. vessel arriving to take on more cargo, requiring no or relatively small releases of BW), or
- both (i.e. transshipment operations that can require some vessels to discharge ballast trim water during part of the unloading /loading cycle whilst alongside a berth or at anchor in the bunders).

Thus unless vessels submit a reasonably complete BWRf, it is not possible to estimate how much BW they may be taking up or releasing owing to the lack of information concerning the amount of cargo already on board and/or retained on board.

By the end of the consultants first visit it was established that the BWRf records collated until December 2001 (as forwarded to DGS for spreadsheet consolidation by the CFP-A) had been returned at a markedly different rates, covering only ~10% of total MPT arrivals and transshipments versus >90% of JNP berth arrivals (transshipments at JNP are relatively few; typically totalling ~35,000 tonnes per year of bagged and dry bulk commodities such as rock phosphate, ammonium sulphate and sulphur). The disparity was due to several factors, particularly:

- the types of trade and compactness of the JNP terminals, plus their modern, computerised management offices located close to the berths<sup>20</sup>;
- the more spatially dispersed and wider range of domestic, overseas and vessel-transfer trades managed by MPT, plus its more paper-reliant and distant record keeping and accounting offices<sup>21</sup>;
- virtual non-collation of BW records from the MPT Pir Pau and Butcher Island oil terminals.

<sup>20</sup> A computerised Control Room Register was maintained at the JNPT offices which *inter alia* recorded the vessel name, flag, call sign, agent, GRT, NRT, DWT, dates of arrival/departure, last port, next port, cargo import/export and, since 2001, if the arrival was intending to discharge ballast

<sup>21</sup> MPT employs over 20,000 staff across a range of buildings and offices near the port. Shipping records include paper Mumbai HM Arrival (121AR1) and Departure (121DR1) Reports, which between them include the ship name and type, flag, call sign, agent, GRT, NRT, DWT, last port, cargo type, arrival date, next port, cargo onboard and departure date (subsequently entered at various stages into FoxPro (DOS), spreadsheets and other systems for generating accounting records and annual statistics).

Because of the number of berths and lack of specific berth number information on the MPT records, main berthing areas managed by the Database and GIS Port Map were therefore consolidated into the following terminals:

MPT: Docks (i.e. Indira, Victoria and Prince's docks and Ballard Pier); Butcher Island products terminal; Butcher Island crude oil terminal; Pir Pau terminal (old and new petrochemical berths).

JNPT: Container berths; Ro-Ro/multi-use berth; Dry bulk berth; Chemical berths.

It was not possible to differentiate which BWRP records might have come from vessels at the MPT transshipment Bunders versus those in the nearby Docks due to the problem of accessing MPT port records, although the Group B coordinator for MPT noted that the vast majority of visit records allocated to the Docks were from such visits.

By the beginning of the February 2003 wrap-up visit, BW statistics could be extracted from the following 3581 visit records in the Access database which covered the period from 2 January 2000 to 7 July 2002:

MPT Pir Pau terminal:	213 chemical tanker, 219 products tanker, 165 oil tanker, 33 gas tanker visits (18 April 2000 - 23 June 2002).
MPT Butcher products berth:	75 products tanker visits (15 April 2000 - 13 June 2002).
MPT Butcher crude berth:	42 crude oil tanker visits (25 April 2000 - 21 June 2002).
MPT Docks:	154 general cargo ship, 303 container ship, 60 small bulk carrier, 13 ro-ro visits (15 April 2000 - 13 June 2002).
JNPT Container Terminal:	1576 container ship, 196 general cargo ship and 23 ro-ro/other visits (1 January - 23 June 2002).
JNPT Dry Bulk Berth:	76 bulk carrier and 12 general cargo ship visits (1 March 2000 - 1 June 2002).
JNPT Ro-Ro (Multi-Use):	103 ro-ro and vehicle carrier visits, with chemical tankers added to the next berth (1 January 2000 - 1 June 2002).
JNPT Chemical Berths:	315 chemical and products tanker visits (2 January 2000 - 10 June 2002).

It needs to be recognised that these visit records do not provide a complete picture of all cargo vessel arrivals. For example, in 2000-2001 there were approximately 10 vessel visits per day to the Port of Mumbai (3,614 for the year), of which 1,921 were cargo carriers (the remainder were 39 passenger carriers and 1,654 rig supply and miscellaneous movements; MPT summary data obtained by Group B). The MPT Annual Report for the same period shows that total cargo import and export tonnages exceeded 15 million and 9 million tonnes respectively. Given the vast majority of vessels servicing this trade arrive to both discharge and load cargo, the Port of Mumbai is overwhelmingly a net exporter of BW.

This pattern is virtually identical to that at JNP, which imported 6.04 million tonnes and exported 3.81 million tonnes of cargo during 2000/2001. During this period, JNP experienced 3,164 vessel movements, of which 1,507 comprised offshore supply vessels, Naval ships and miscellaneous movements. Vessels arriving to discharge and/or load cargo comprised 1,247 container and general cargo ships, 269 chemical and other tankers, 88 dry bulk carriers and 53 ro-ro/vehicles carriers (JNPT Annual Report summary).

The database stores the amounts and sources of BW discharged recorded for these arrivals, as entered from BWRFs before, during and after the consultants first and second visits, with many of these records partly supplemented and/or wholly derived from port shipping records. Connection of the database to the active berth layer of the GIS Port Map allowed tables summarising the BW discharge statistics to be conveniently displayed for each terminal. Examples of these tables displayed by the GIS Port Map are shown in Figures 13-17 respectively.

Because the database must accept and manage individual tank discharges as discrete units (as recorded in IMO-standard BWRFs; Appendix 1), the need to treat all BW tanks as a single entity for all vessels arriving prior to BWRF use (or which submit non-standard BWRFs or incomplete IMO BWRFs; Section 3.6) reduces the number of individual tank discharges actually made between January 2000 and June 2002, whilst inflating the mean and maximum tank discharge volumes. Thus the latter can reflect the total ballast water capacity of the largest visiting vessels (Figures 15-17). This causes more conservative outcomes in terms of BWRA results, particularly if a source port is exporting BW to the Demonstration site via relatively large vessels arriving in a fully ballasted condition.

While this is an uncommon feature of Mumbai-JNP’s trade, it is worth emphasising that a database containing individual tank data collated from, say, a 12 month set of fully completed BWRFs, will generate more precise BW source port values for the C1, C2 and R1 components (Section 3.10).

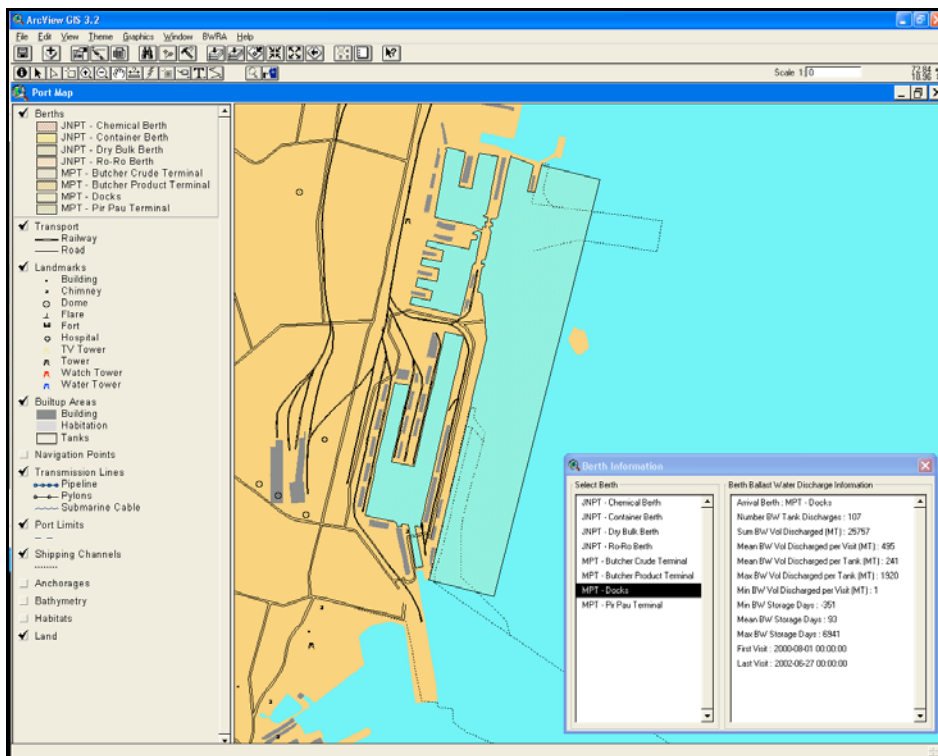

Figure 13. BW discharge statistics displayed by GIS port map for the Mumbai docks

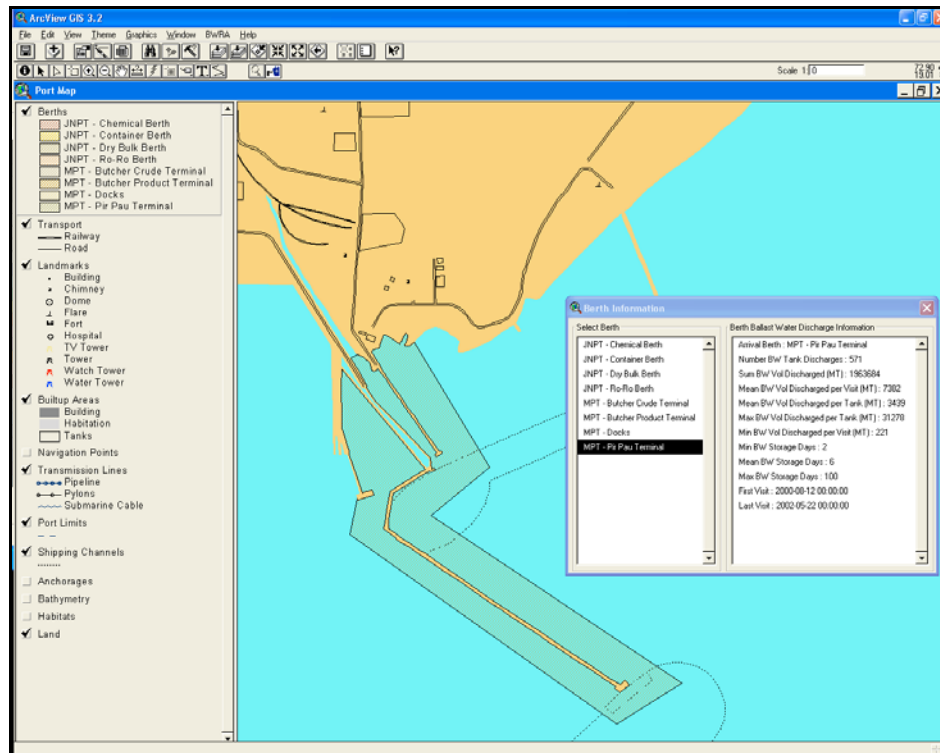

Figure 14. BW discharge statistics displayed by GIS port map for the Pir Pau terminal

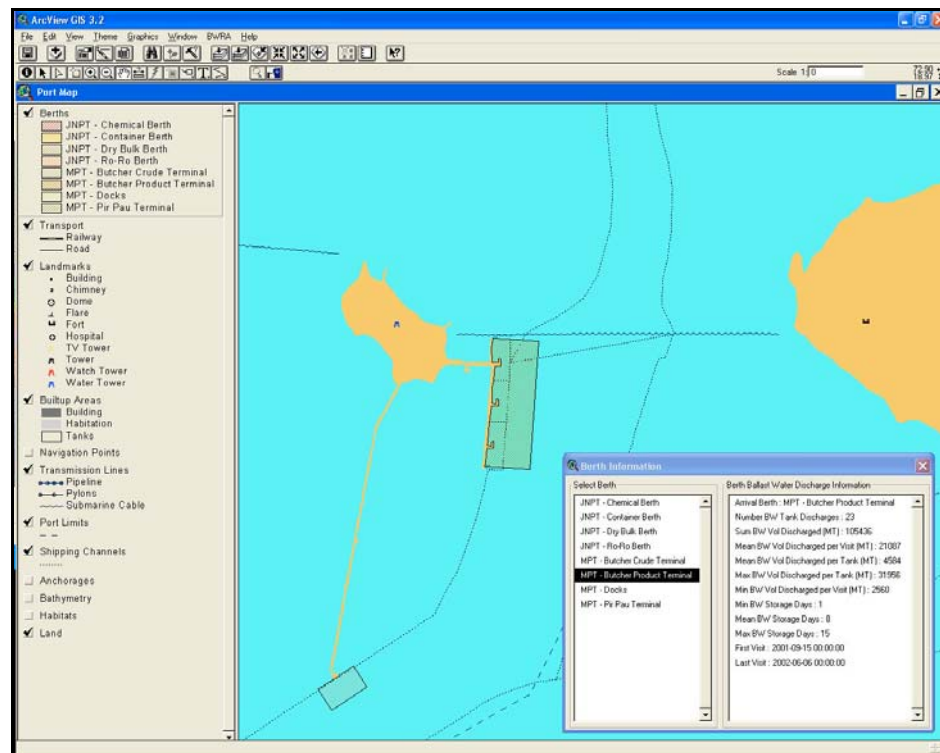

Figure 15a. BW discharge statistics displayed for the Butcher Island products terminal

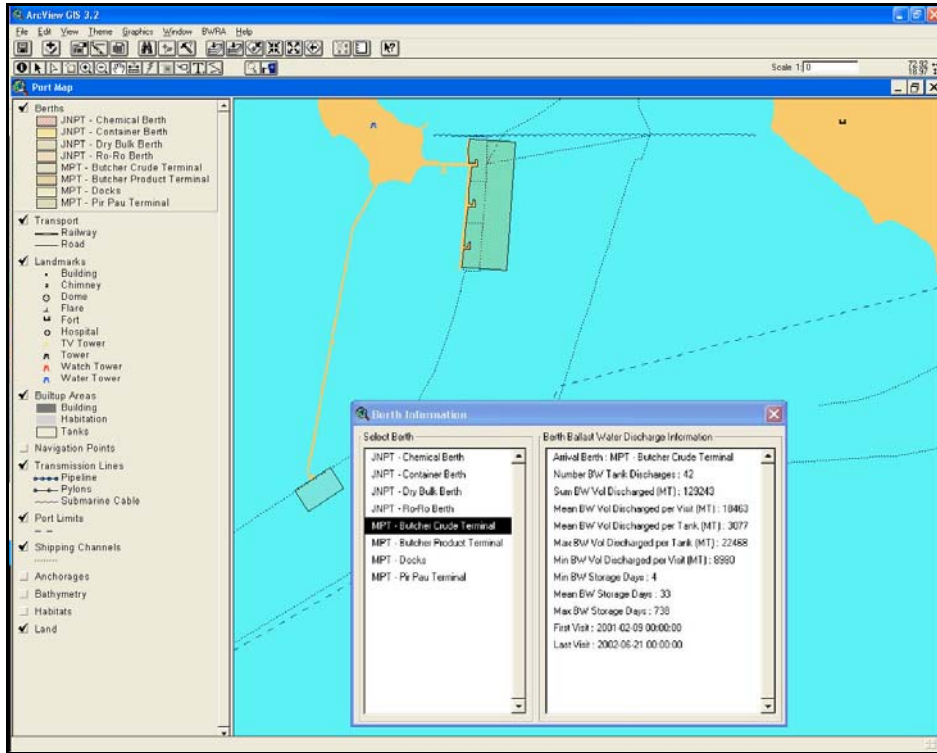

Figure 15b. BW discharge statistics displayed for the Butcher Island crude terminal

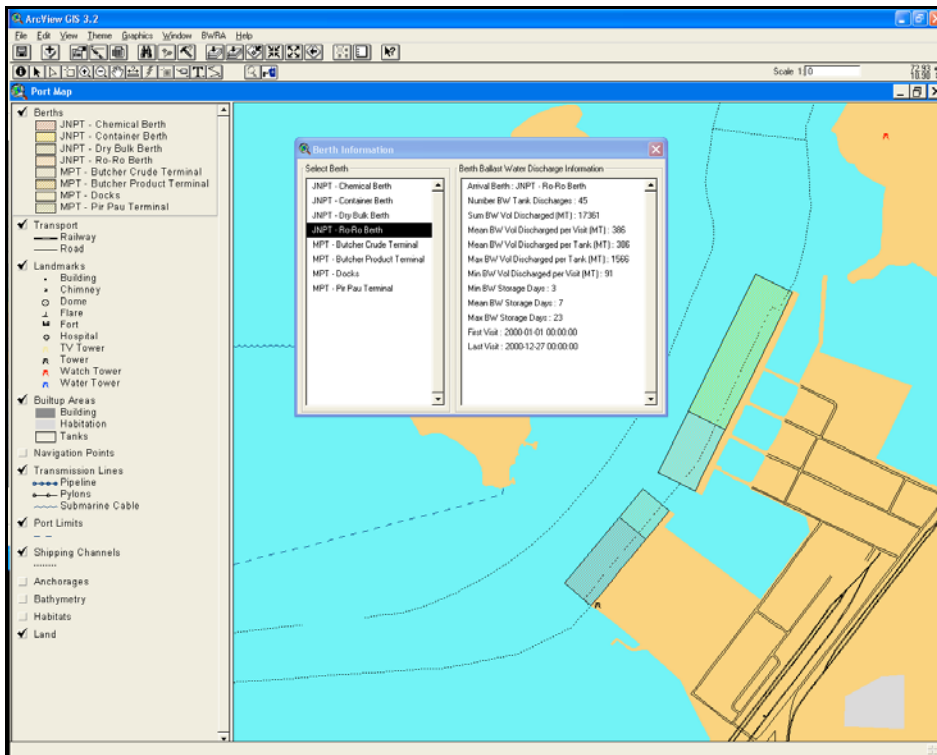

Figure 16a. BW discharge statistics displayed by the port map for the JNP Ro-Ro terminal

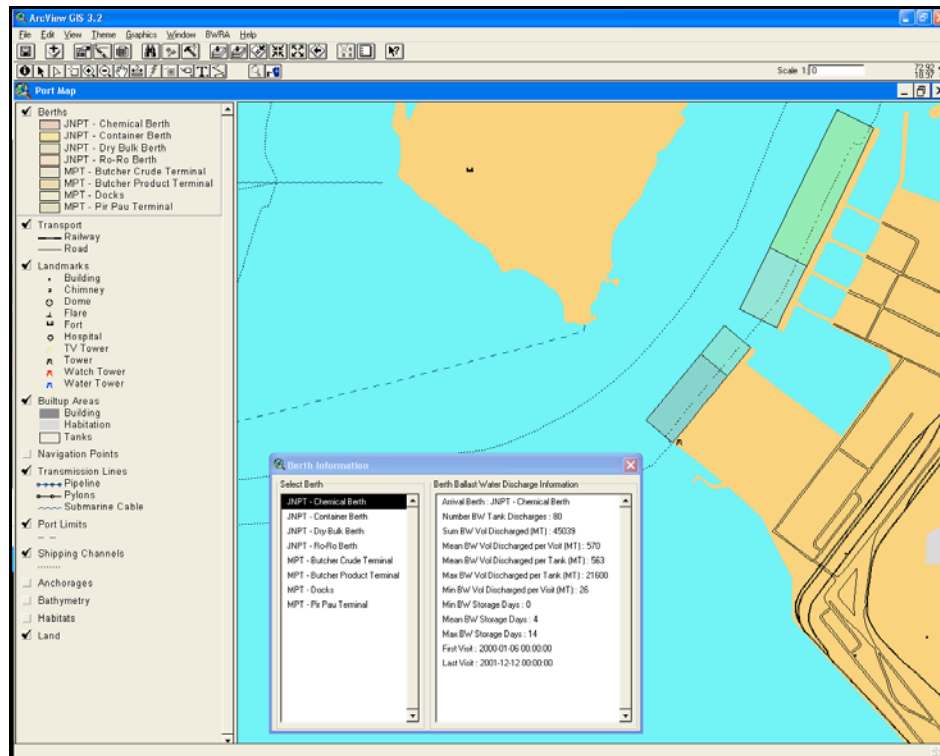

Figure 16b. BW discharge statistics displayed for the JNP Chemical terminal

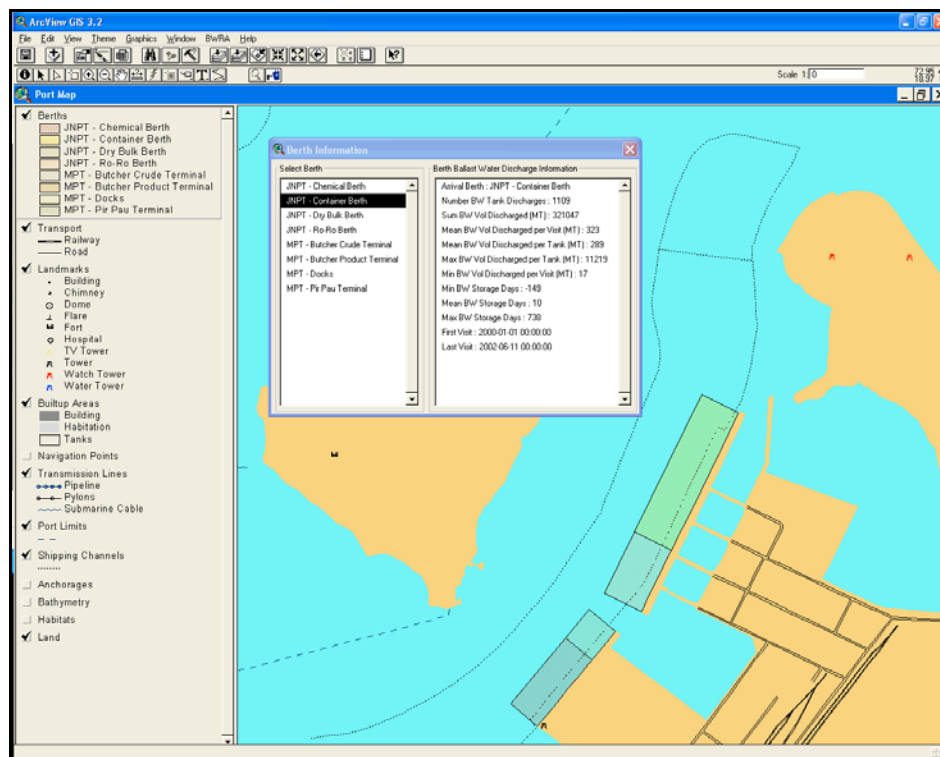

Figure 17a. BW discharge statistics displayed for the JNP Container terminal

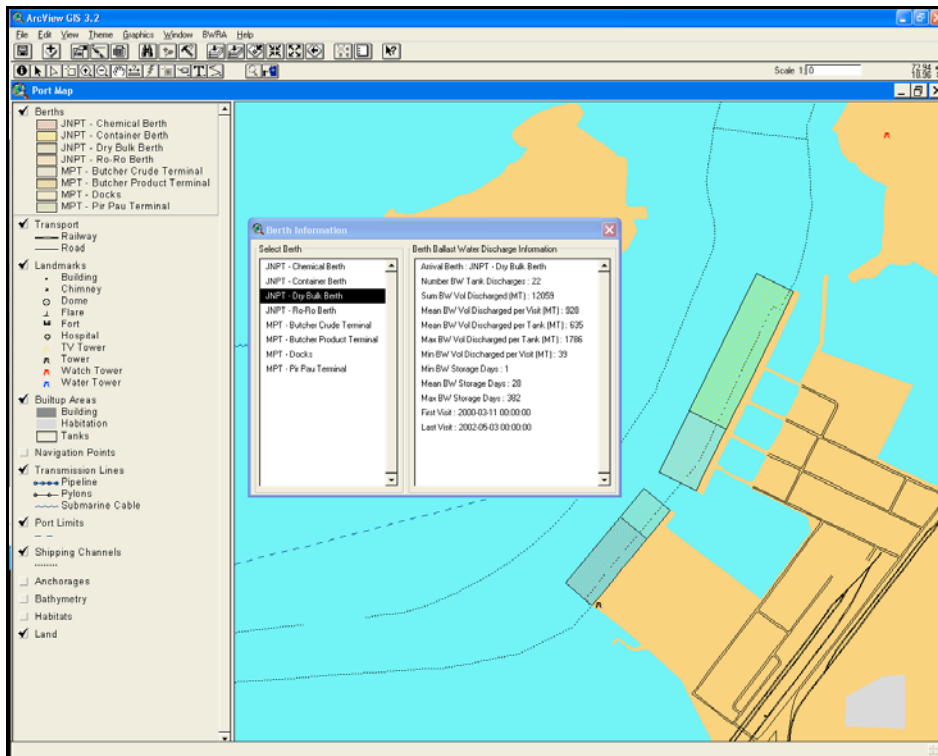

Figure 17b. BW discharge statistics displayed for the JNP Dry Bulk terminal

#### 4.4 Identification of source ports

From the 3,581 vessel visit records and 4,934 associated BW tank records in the 2000-2002 database for Mumbai-JNP, the total number of identified BW source ports was 82 (Table 3). Figure 18 shows output from the GIS world bioregion map depicting the location and relative importance of these source ports with respect to C1 (BW discharge frequency). As with all GIS outputs, the map is 'zoomable' to allow all ports and symbols to be clearly delineated at smaller scales.

The percentage frequency values for the 82 identified source ports listed in Table 3 are the C1 coefficients used to calculate the relative overall risk (Section 3.10). The three source ports 'supplying' the highest frequencies of BW discharges in the database were Karachi (13.9%), Singapore (10.9%) and Colombo (10.1%) (Figure 18). These were followed by Jebel Ali (UAE; %), Kandla (India; 4.2%) and Mohammed Bin Qasim (Pakistan; 4.0%) and Dubai and Fujairah (UAE; both 3.5%).

Of the 82 identified source ports, the top 6 and 16 provided >50% and >75% of the source-identified discharges respectively, while the next 8 ports contributed a further 15%, i.e. only 24 of the 82 source ports (29%) accounted for 90% of all source-identified BW discharges (Table 3).

As noted earlier, the relatively low number of tank records (4,934) compared to visits (3,581), was due to (a) the need to include port shipping records prior to the regular use of BWRFs (all tanks combined), and (b) many vessels recording a single volume for discharged tanks. The total volume of BW discharged from identified source ports of the 4,581 vessel visits was 2,619,625 tonnes. The various discharge percentages for each source port in Table 3 and Figure 19 provide the C2 values used in the risk calculation (Section 3.10).

The port rankings for C2 (BW volume) were similar but not the same as those for C1 (i.e. discharge frequencies, as ranked in Table 3). The source ports providing the largest volume of BW discharged at Mumbai-JNP were Sikka (17.4%), Chennai (12.8%) and Cochin (9.7%) in India, followed by Singapore (8.1%; Table 3). These were followed by Dubai (4.8%), Kandla (4.7%) and Surat (4.2%)(Table 3).

The top five identified source ports provided >50% of the total discharged volume, and the next seven ports a further 25%. Thus only 12 of the identified source ports (14.6%) accounted for >75% of the source-identified BW discharges recorded for Mumbai-JNP. Of the top 20 ports in terms of total discharge volume (89%), 12 were in India, two were in the United Arab Emirates (Dubai and Jebel Ali), and one each in the Netherlands (Rotterdam), Oman (Salalah), Pakistan (Karachi), Singapore, South Africa (Richards Bay) and Sri Lanka (Colombo).



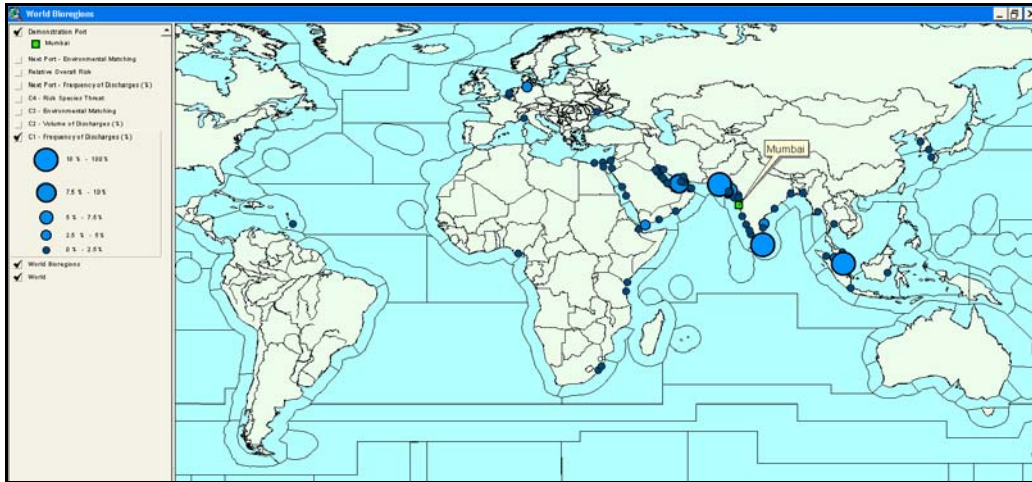

Figure 18. GIS output showing the location and relative importance of BW source ports with respect to frequency of tank discharges (C1) at Mumbai-JNP.

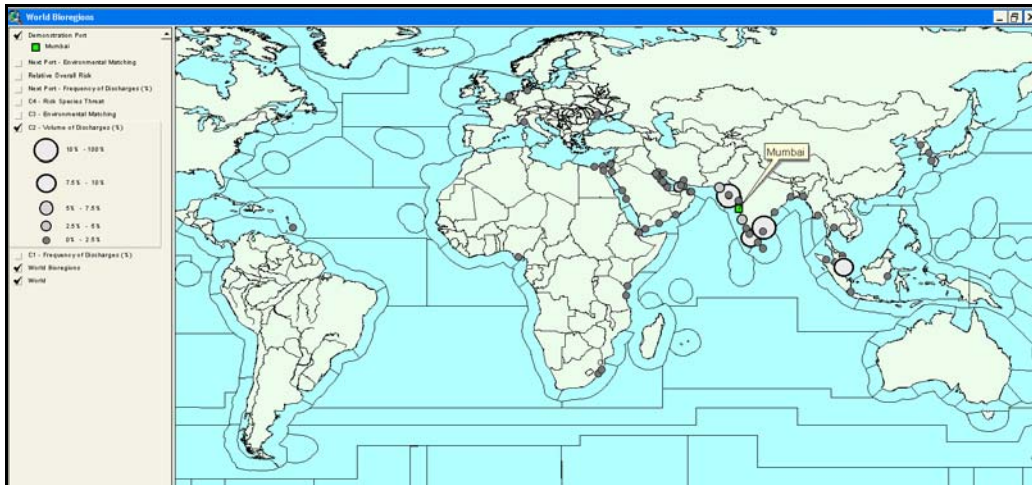

Figure 19. GIS output showing location and relative importance of the source ports with respect to the volume of BW discharges (C2) recorded for Mumbai-JNP.

Table 3. List of identified source ports in Mumbai-JNP database, showing proportions of recorded ballast tank discharges (C1) and volumes (C2)\*

	UN Port Code	Source Port Name	Country	C1*	BW vol. (tonnes)	C2
1	PKKHI	Karachi	Pakistan	14.9%	74,373	2.8%
2	SGSIN	Singapore	Singapore	10.9%	212,834	8.1%
3	LKCMB	Colombo	Sri Lanka	10.1%	45,493	1.7%
4	AEJEA	Jebel Ali	United Arab Emirates	8.0%	75,592	2.9%
5	INIXY	Kandla (Muldwarka)	India	5.8%	122,114	4.7%
6	PKBQM	Muhammad Bin Qasim	Pakistan	4.0%	25,055	1.0%
7	AEDXB	Dubai	United Arab Emirates	3.5%	126,590	4.8%
8	AEFJR	Fujairah (Al-Fujairah)	United Arab Emirates	3.5%	11,248	0.4%
9	DEHAM	Hamburg	Germany Federal Republic Of	3.4%	25,478	1.0%
10	INMAA	Chennai (Ex Madras)	India	2.9%	335,194	12.8%
11	YEADE	Aden	Yemen	2.7%	14,633	0.6%
12	INSIK	Sikka (Jamnagar)	India	2.6%	455,699	17.4%
13	MYPKG	Port Kelang	Malaysia	2.5%	12,011	0.5%
14	INCOK	Cochin	India	2.2%	254,161	9.7%
15	KEMBA	Mombasa	Kenya	2.1%	15,030	0.6%
16	AEKLF	Khorr Al Fakkan	United Arab Emirates	1.9%	9,690	0.4%

\*C1 = percentage proportion of all discharges; C2 = % proportion of total discharge volume

**Table 3 (cont'd).** List of identified source ports in Mumbai-JNP database, showing proportions of recorded ballast tank discharges (C1) and volumes (C2)\*

	UN Port Code	Source Port Name	Country	C1*	BW vol. (tonnes)	C2
17	INTUT	Tuticorin (New Tuticorin)	India	1.9%	63,780	2.4%
18	AEAUH	Abu Dhabi	United Arab Emirates	1.7%	2,961	0.1%
19	INMUN	Mundra	India	1.0%	56,860	2.2%
20	OMSL	Salalah	Oman	1.0%	32,820	1.3%
21	INDAM	Daman	India	0.9%	4,222	0.2%
22	INMRM	Marmugao (Marmagoa)	India	0.9%	95,895	3.7%
23	IRBND	Bandar Abbas	Iran Islamic Republic of	0.9%	6,244	0.2%
24	KWKWI	Kuwait	Kuwait	0.7%	2,950	0.1%
25	BDCGP	Chittagong	Bangladesh	0.6%	14,948	0.6%
26	INSTV	Surat	India	0.6%	109,934	4.2%
27	JOAQJ	Aqaba (El Akaba)	Jordan	0.6%	12,722	0.5%
28	AEQIW	Umm Al Qiwain	United Arab Emirates	0.5%	1,143	0.04%
29	INIXE	Mangalore (New Mangalore)	India	0.5%	59,578	2.27%
30	NLRMT	Rotterdam	Netherlands	0.44%	30,592	1.17%
31	SAJUB	Jubail	Saudi Arabia	0.44%	24,947	0.95%
32	INHAL	Haldia	India	0.37%	14,063	0.54%
33	SAJED	Jeddah	Saudi Arabia	0.37%	1,751	0.07%
34	DJJIB	Djibouti	Djibouti	0.31%	1,523	0.06%
35	EGPSD	Port Said	Egypt	0.31%	3,517	0.13%
36	IDBLW	Belawan Sumatra	Indonesia	0.31%	1,500	0.06%
37	INHAZ	Hazira	India	0.31%	48,903	1.87%
38	INVAD	Vadinar	India	0.31%	53,244	2.03%
39	INVTZ	Visakhapatnam	India	0.25%	34,696	1.32%
40	THLCH	Laem Chabang	Thailand	0.25%	1,633	0.06%
41	TZDAR	Dar Es Salaam	Tanzania United Republic Of	0.25%	816	0.03%
42	ZADUR	Durban	South Africa	0.25%	10,818	0.41%
43	ZARCB	Richards Bay	South Africa	0.25%	33,718	1.29%
44	OMMCT	Muscat	Oman	0.19%	562	0.02%
45	QAUMS	Umm Said	Qatar	0.19%	15,752	0.60%
46	AEAJM	Ajman	United Arab Emirates	0.12%	184	0.01%
47	BHMAN	Manama	Bahrain	0.12%	857	0.03%
48	EGSUZ	Suez (El Suweis)	Egypt	0.12%	11,930	0.5%
49	INCCJ	Calicut	India	0.12%	8,934	0.34%
50	INKRW	Karwar	India	0.12%	1,466	0.06%
51	INPAV	Pipavav (Victor) Port	India	0.12%	599	0.02%
52	KRINC	Inchon	Korea Republic of	0.12%	547	0.02%
53	MYDGN	Dungun (Kuala Dungun)	Malaysia	0.12%	257	0.01%
54	OMOPQ	Port Sultan Qaboos	Oman	0.12%	281	0.01%
55	SAYNB	Yanbu	Saudi Arabia	0.12%	6,850	0.26%
56	BBBGI	Bridgetown	Barbados	0.06%	323	0.01%
57	BEANR	Antwerpen	Belgium	0.06%	405	0.02%
58	CYKYR	Kyrenia	Cyprus	0.06%	3,970	0.15%
59	DKAAB	Aabenraa	Denmark	0.06%	5,635	0.22%
60	EGALY	Alexandria (El Iskandariya)	Egypt	0.06%	754	0.03%
61	IDBPN	Balikpapan Kalimantan	Indonesia	0.06%	7,356	0.28%
62	IDMRK	Merak Java	Indonesia	0.06%	409	0.02%
63	ILASH	Ashdod	Israel	0.06%	136	0.01%
64	INDAH	Dahej	India	0.06%	200	0.01%
65	INPBD	Porbandar	India	0.06%	84	0.00%
66	INPNY	Pondicherry	India	0.06%	5,843	0.22%
67	IRKHK	Khark Island	Iran Islamic Republic of	0.06%	2,427	0.09%
68	ITGOA	Genoa	Italy	0.06%	670	0.03%
69	JPNGS	Nagasaki Nagasaki	Japan	0.06%	303	0.01%
70	KRPUS	Pusan	Korea Republic of	0.06%	313	0.01%
71	MMRGN	Yangon (Rangoon)	Myanmar (Former Burma)	0.06%	1,161	0.04%
72	MYKUA	Kuantan (Tanjong Gelang)	Malaysia	0.06%	179	0.01%
73	UAILK	Ilyichevsk	Ukraine	0.06%	219	0.01%
74	YEMKX	Mukalla	Yemen	0.06%	52	0.00%
75	AEFAT	Fateh Terminal	United Arab Emirates	0.06%	<50	0.00%
76	IQMAB	Mina Al Bakir	Iraq	0.06%	<50	0.00%
77	KWMEA	Mina Al Ahmadi	Kuwait	0.06%	<50	0.00%
78	LYKHO	Khoms	Lybian Arab Jamahiriya	0.06%	<50	0.00%
79	MYLUT	Lutong Sarawak	Malaysia	0.06%	<50	0.00%
80	NGBON	Bonny	Nigeria	0.06%	<50	0.00%
81	SARAR	Ras al Khafji	Saudi Arabia	0.06%	<50	0.00%
82	SARTA	Ras Tanura	Saudi Arabia	0.06%	<50	0.00%

\*C1 = proportion of all discharges; C2 = proportion of total discharge volume (%)

#### 4.5 Identification of destination ports

As discussed in Section 3.5, identification of destination ports for any BW taken up at a Demonstration Site is confounded by the lack specific questions on the BWRP, and the uncertainty of knowing if the Next of Port Call recorded on a BWRP (or in a shipping record) is where BW is actually discharged. Thus presently there is no reporting mechanism enabling a 'reverse BWRA' to be undertaken reliably. This posed a significant constraint for Mumbai-JNP, since it is not clear which of the large number of container ships, general cargo ships and small bulk carriers had or had not uplifted BW whilst alongside berths or in the transshipment anchorages.

To provide an idea of the number of inter-port movements between Mumbai and JNP, Table 4 lists the proportional frequency of reported movements to Mumbai (8.7%) and to JNP (0.7%). Of the other 106 assumed BW destination ports (i.e. Next Ports of Call) identified in the 2000-2002 database, their location and proportional frequency are shown in Figure 20 as well as Table 4. Table 4 lists the top 27 destination ports that accounted for >90% of the reported Next Ports of Call by all recorded vessel departures. Figure 20 and Table 4 show that the Port of Colombo (Sri Lanka; Figure 2) stood out as the most frequent destination port, with 12.5% of all Next Ports of Call. This may be related to (a) the frequency of container liner and other regular services from the Middle East and Europe (which stop at Mumbai before heading south-east to Colombo, the next container hub), (b) regular exports of product and petrochemicals to Sri Lanka, and/or (c) use of Colombo as a strategic 'destination' for initial sailing instructions.

The source and destination plots shown in Figures 19 and 20 show how Mumbai-JNP form a significant hub in the Indian Ocean, with most of their trading voyages occurring in the area between the Red Sea and Gulf (ROPME Sea Area) and the Indo-Malay peninsula.

Of the top 17 ports accounting for 80% of the destinations recorded for vessels departing Mumbai-JNP, five were Indian, seven were in the Middle East (Oman, Egypt, Saudi Arabia, United Arab Emirates) and the others were single ports in Malaysia, Pakistan, Singapore, Sri Lanka and United States (Table 4).

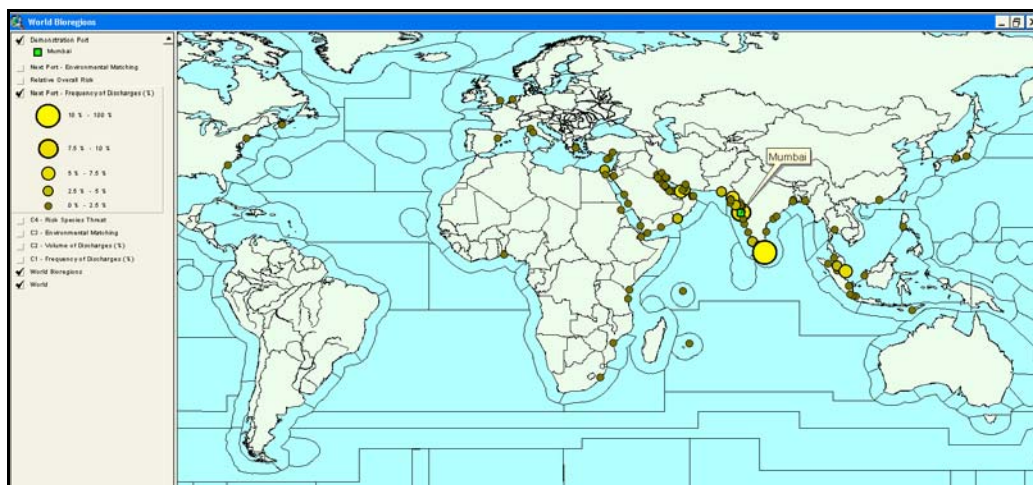

**Figure 20.** GIS output showing the location and frequency of destination ports, recorded as the Next Port of Call in the Mumbai-JNP BWRPs and shipping records.

**Table 4.** BW destination ports accounting for >80% of all vessel departures from Mumbai-JNP in 2000-2002 (recorded as Next Ports of Call).

	UN Port Code	Destination Port (Next Port of Call)	Country	% Proportion of Departures	Cumulative %
1	LKCMB	Colombo	Sri Lanka	12.5	12.5
2	INBOM	Mumbai (Ex Bombay)	India	8.72	21.3
3	SGSIN	Singapore	Singapore	7.42	28.7
4	AEJEA	Jebel Ali	United Arab Emirates	6.94	35.6
5	INIXY	Kandla (Muldwarka)	India	5.49	41.1
6	PKKHI	Karachi	Pakistan	4.78	45.9
7	MYPKG	Port Kelang	Malaysia	4.56	50.5
8	OMSLI	Salalah	Oman	4.19	54.6
9	INCOK	Cochin	India	3.86	58.5
10	EGPSD	Port Said	Egypt	3.64	62.1
11	AEDXB	Dubai	United Arab Emirates	3.30	65.4
12	AEFJR	Fujairah (Al-Fujairah)	United Arab Emirates	3.15	68.6
13	INPAV	Pipavav (Victor) Port	India	3.12	71.7
14	AEKLF	Khor Al Fakkan	United Arab Emirates	2.67	74.4
15	INTUT	Tuticorin (New Tuticorin)	India	2.56	76.9
16	SAJED	Jeddah	Saudi Arabia	2.41	79.4
17	USNYC	New York New York	United States	2.19	81.5
18	EGSUZ	Suez (El Suweis)	Egypt	1.67	83.2
19	INIXE	Mangalore (New Mangalore)	India	1.63	84.8
20	MYPEN	Penang (Georgetown)	Malaysia	0.89	85.7
21	INSIK	Sikka (Jamnagar)	India	0.78	86.5
22	MUPLU	Port Louis	Mauritius	0.78	87.3
23	IDBLW	Belawan Sumatra	Indonesia	0.67	88.0
24	INNSA	Jawaharlal Nehru (Nhava Sheva)	India	0.67	88.6
25	INMAA	Chennai (Ex Madras)	India	0.59	89.2
26	INMUN	Mundra	India	0.56	89.8
27	YEHOD	Hodeidah	Yemen	0.56	90.3

#### 4.6 Environmental similarity analysis

Of the identified 82 BW source ports and 108 destination ports, sufficient port environmental data were obtained to include 77% of the former and 71% of the latter in the multivariate similarity analysis by PRIMER. These ports accounted for 95.7% of recorded BW tank discharges and 92.5% of all recorded departures respectively (Tables 5-6). Details of the 357 ports included in the multivariate analysis carried out for Mumbai-JNP and the other Demonstration Site BWRAs are listed in Appendix 6 (this list is ordered alphabetically using the UN port identification code, in which the first two letters represent the country).

To allow all identified BW source and next ports of Mumbai-JNP to be part of the ‘first-pass’ risk assessment, those ports not included in the multivariate analysis were provided with environment matching coefficient estimates, and are noted as such in the database. The C3 estimates were based on their port type (Section 3.7) and geographic location with respect to the nearest comparable ports for which C3 had been calculated. A precautionary approach was adopted (i.e. the estimated values were made higher than the calculated C3s of comparable ports). Providing C3 estimates allowed the database to include all the identified source ports and next ports when calculating the ROR values and displaying the BWRA results.

The GIS world map outputs that display the C3 values of Mumbai-JNP’s source and destination ports are in Figures 21 and 22 respectively. These plots and Tables 5-6 show that Mumbai-JNP has a moderately high environmental similarity to some 23 (28%) of its trading ports (i.e. C3s in the 0.5 - 0.7 range, with the four ports greater than 0.6). In fact all of the closest ports (C3 >0.535) are in the humid tropical Asian and African regions that experience relatively intense seasonal monsoons.

It is not surprising that the most environmentally similar ports to Mumbai-JNP were Mangalore (0.64), Pondichery (C3 estimated), Marmagao (0.62) and Porbandar (0.61; Table 5). The most environmentally dissimilar ports trading with Mumbai-JNP in 2000-2002 were those in northern

Europe (i.e. Hamburg, Ilyichevsk and Antwerpen), which had C3s at or below 0.2 (Tables 5-6; Figures 21, 22).

As discussed in Section 4.6 and highlighted in Figure 20, the most frequent destination port recorded for Mumbai-JNP (12.5% of all departures) was Colombo, which had a moderate environmental matching (0.54; Table 6; Figure 22). The assumed BW destination ports with the closest environmental matches (i.e. Mangalore [0.64] and Marmagao [0.62]) were ranked 18<sup>th</sup> and 32<sup>rd</sup> as Next Ports of Call (i.e. 1.63% and 0.3%), while Porbandar (C3 of 0.61) and Mandapam (estimated C3 of 0.60) were ranked 43<sup>rd</sup> and 89<sup>th</sup> as assumed BW destination ports.

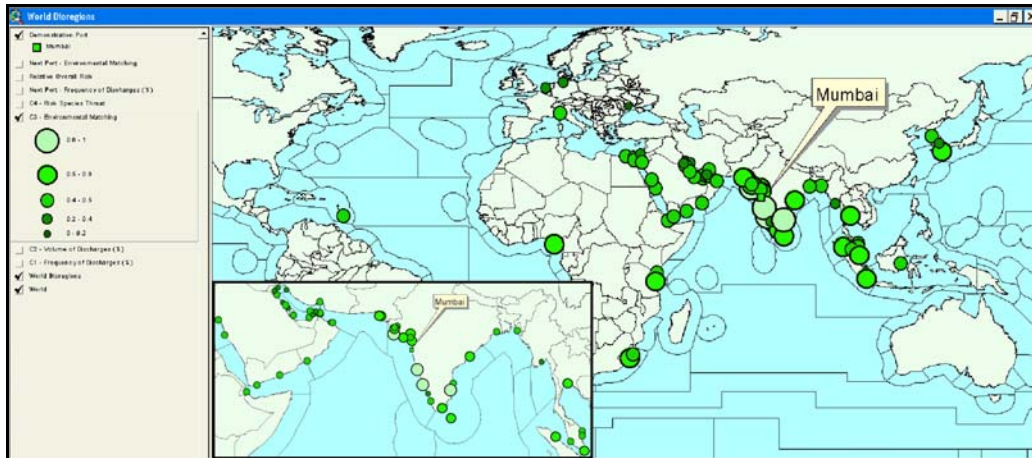

**Figure 21.** GIS outputs showing the location and environmental matching coefficients (C3) of BW source ports identified for Mumbai-JNP.

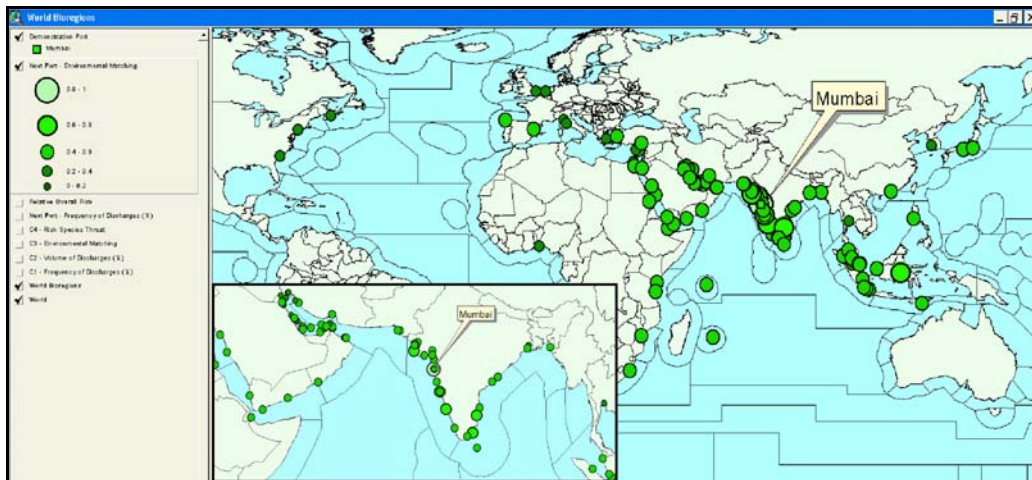

**Figure 22.** GIS outputs showing the location and environmental matching coefficients (C3) of the destination ports identified for Mumbai-JNP.

**Table 5.** Source ports identified for Mumbai-JNP, as ranked according to size of their environmental matching coefficient (C3)

UN Port Code	Source Port Name	Country	Proportion of BW discharged	Environmental Matching (C3)	C3 Estimated
INIXE	Mangalore (New Mangalore)	India	0.50%	0.642	
INPNY	Pondicherry	India	0.06%	0.639	Y
INMRM	Marmugao (Marmagoa)	India	0.93%	0.624	
INPBD	Porbandar	India	0.06%	0.609	
IDBLW	Belawan Sumatra	Indonesia	0.31%	0.593	
NGBON	Bonny	Nigeria	0.06%	0.586	
INTUT	Tuticorin (New Tuticorin)	India	1.87%	0.580	
PKBQM	Muhammad Bin Qasim	Pakistan	3.98%	0.576	
THLCH	Laem Chabang	Thailand	0.25%	0.574	
INPAV	Pipavav (Victor) Port	India	0.12%	0.570	Y
IDMRK	Merak Java	Indonesia	0.06%	0.554	
MYLUT	Lutong Sarawak	Malaysia	0.06%	0.550	Y
INVTZ	Visakhapatnam	India	0.25%	0.547	
LKCMB	Colombo	Sri Lanka	10.07%	0.542	
PKKHI	Karachi	Pakistan	14.86%	0.535	
ZADUR	Durban	South Africa	0.25%	0.534	
SGSIN	Singapore	Singapore	10.95%	0.530	
TZDAR	Dar Es Salaam	Tanzania United Republic Of	0.25%	0.526	
JPNGS	Nagasaki Nagasaki	Japan	0.06%	0.523	
INDAH	Dahej	India	0.06%	0.500	Y
INDAM	Daman	India	0.93%	0.500	Y
INSTV	Surat	India	0.62%	0.500	Y
INVAD	Vadinar	India	0.31%	0.500	
EGSUZ	Suez (El Suweis)	Egypt	0.12%	0.496	
INCOK	Cochin	India	2.24%	0.495	
MYKUA	Kuantan (Tanjong Gelang)	Malaysia	0.06%	0.494	Y
INHAL	Haldia	India	0.37%	0.494	
INMAA	Chennai (Ex Madras)	India	2.92%	0.493	
KEMBA	Mombasa	Kenya	2.05%	0.482	
ZARCB	Richards Bay	South Africa	0.25%	0.477	
SAYNB	Yanbu	Saudi Arabia	0.12%	0.477	
OMOPQ	Port Sultan Qaboos	Oman	0.12%	0.460	Y
OMSLL	Salalah	Oman	1.00%	0.460	Y
SAJED	Jeddah	Saudi Arabia	0.37%	0.459	
MYPKG	Port Kelang	Malaysia	2.49%	0.457	
INSIK	Sikka (Jamnagar)	India	2.61%	0.456	
IRBND	Bandar Abbas	Iran Islamic Republic of	0.87%	0.456	
AEDXB	Dubai	United Arab Emirates	3.54%	0.450	
DKAAB	Aabenraa	Denmark	0.06%	0.450	Y
IDBPN	Balikpapan Kalimantan	Indonesia	0.06%	0.450	Y
INHAZ	Hazira	India	0.31%	0.450	Y
INKRW	Karwar	India	0.12%	0.450	Y
JOAQJ	Aqaba (El Akaba)	Jordan	0.56%	0.450	Y
AEFAT	Fateh Terminal	United Arab Emirates	0.06%	0.446	
KRINC	Inchon	Korea Republic of	0.12%	0.444	
AEKLF	Khor Al Fakkan	United Arab Emirates	1.93%	0.444	
SARAR	Ras al Khafji	Saudi Arabia	0.06%	0.437	
MYDGN	Dungun (Kuala Dungun)	Malaysia	0.12%	0.436	
INMUN	Mundra	India	1.00%	0.435	
YEADE	Aden	Yemen	2.74%	0.423	
YEMKX	Mukalla	Yemen	0.06%	0.419	
BDCGP	Chittagong	Bangladesh	0.62%	0.415	
INIXY	Kandla (Muldwarka)	India	5.78%	0.415	
EGALY	Alexandria (El Iskandariya)	Egypt	0.06%	0.412	
BBBGI	Bridgetown	Barbados	0.06%	0.412	Y
DJJIB	Djibouti	Djibouti	0.31%	0.411	
CYKYR	Kyrenia	Cyprus	0.06%	0.410	
AEAUH	Abu Dhabi	United Arab Emirates	1.68%	0.408	
AEFJR	Fujairah (Al-Fujairah)	United Arab Emirates	3.54%	0.402	
SARTA	Ras Tanura	Saudi Arabia	0.06%	0.401	
AEAJM	Ajman	United Arab Emirates	0.12%	0.401	Y
ITGOA	Genoa	Italy	0.06%	0.400	
LYKHO	Khoms	Lybian Arab Jamahiriya	0.06%	0.400	Y
QAUMS	Umm Said	Qatar	0.19%	0.400	

**Table 5 (cont'd).** Source ports identified for Mumbai-JNP, ranked according to the size of their environmental matching coefficient (C3)

UN Port Code	Source Port Name	Country	Proportion of BW discharged	Environmental Matching (C3)	C3 Estimated
KWMEA	Mina Al Ahmadi	Kuwait	0.06%	<b>0.399</b>	
BHMAN	Manama	Bahrain	0.12%	<b>0.397</b>	
AEJEA	Jebel Ali	United Arab Emirates	7.96%	<b>0.391</b>	
AEQIW	Umm Al Qiwain	United Arab Emirates	0.50%	<b>0.384</b>	
KWKWI	Kuwait	Kuwait	0.68%	<b>0.368</b>	
OMMCT	Muscat	Oman	0.19%	<b>0.351</b>	Y
IQMAB	Mina Al Bakir	Iraq	0.06%	<b>0.336</b>	Y
IRKHK	Khark Island	Iran Islamic Republic of	0.06%	<b>0.331</b>	
KRPUS	Pusan	Korea Republic of	0.06%	<b>0.302</b>	
INCCJ	Calicut	India	0.12%	<b>0.299</b>	Y
SAJUB	Jubail	Saudi Arabia	0.44%	<b>0.297</b>	
MMRGN	Yangon (Rangoon)	Myanmar (Former Burma)	0.06%	<b>0.295</b>	
ILASH	Ashdod	Israel	0.06%	<b>0.262</b>	
NLRTM	Rotterdam	Netherlands	0.44%	<b>0.245</b>	
EGPSD	Port Said	Egypt	0.31%	<b>0.217</b>	
DEHAM	Hamburg	Germany Federal Republic Of	3.36%	<b>0.201</b>	
UAILK	Ilyichevsk	Ukraine	0.06%	<b>0.179</b>	
BEANR	Antwerpen	Belgium	0.06%	<b>0.143</b>	

**Table 6.** Destination ports identified for Mumbai-JNP, ranked according to the size of their environmental matching coefficient (C3)\*

UN Port Code	Port Name	Country	Proportion of Departures	Environmental Matching (C3)	C3 Estimated
INIXE	Mangalore (New Mangalore)	India	1.63	<b>0.642</b>	
INMRM	Marmugao (Marmagoa)	India	0.30	<b>0.624</b>	
INPBD	Porbandar	India	0.19	<b>0.609</b>	
INMDP	Mandapam	India	0.04	<b>0.600</b>	Y
IDBLW	Belawan Sumatra	Indonesia	0.67	<b>0.593</b>	
INTUT	Tuticorin (New Tuticorin)	India	2.56	<b>0.580</b>	
PKBQM	Muhammad Bin Qasim	Pakistan	0.30	<b>0.576</b>	
INPAN	Panaji Port (Goa)	India	0.15	<b>0.571</b>	
INPAV	Pipavav (Victor) Port	India	3.12	<b>0.570</b>	
MYPDI	Port Dickson	Malaysia	0.11	<b>0.564</b>	
IDDUM	Dumai Sumatra	Indonesia	0.04	<b>0.560</b>	
PHMNL	Manila	Philippines	0.04	<b>0.559</b>	
IDKOE	Kupang Timor	Indonesia	0.04	<b>0.554</b>	Y
IDMRK	Merak Java	Indonesia	0.04	<b>0.554</b>	
INVTZ	Visakhapatnam	India	0.11	<b>0.547</b>	
LKCMB	Colombo	Sri Lanka	12.54	<b>0.542</b>	
PKKHI	Karachi	Pakistan	4.78	<b>0.535</b>	
ZADUR	Durban	South Africa	0.30	<b>0.534</b>	
SGSIN	Singapore	Singapore	7.42	<b>0.530</b>	
TZDAR	Dar Es Salaam	Tanzania United Republic Of	0.04	<b>0.526</b>	
IDPLM	Palembang Sumatra	Indonesia	0.04	<b>0.521</b>	Y
INRTC	Ratnagiri	India	0.07	<b>0.520</b>	Y
IDPNJ	Panjang	Indonesia	0.04	<b>0.520</b>	Y
IDPNK	Pontianak Kalimantan	Indonesia	0.04	<b>0.520</b>	Y
IDJKT	Jakarta Java	Indonesia	0.07	<b>0.519</b>	
SDPZU	Port Sudan	Sudan	0.04	<b>0.502</b>	
INDAM	Daman	India	0.22	<b>0.500</b>	Y
INBED	Bedi	India	0.11	<b>0.500</b>	Y
INDAH	Dahej	India	0.07	<b>0.500</b>	Y
INVAD	Vadinar	India	0.19	<b>0.500</b>	

**Table 6 (cont'd).** Destination ports identified for Mumbai-JNP, ranked according to the size of their environmental matching coefficient (C3)

UN Port Code	Port Name	Country	Proportion of Departures	Environmental Matching (C3)	C3 Estimated
EGSUZ	Suez (El Suweis)	Egypt	1.67	0.496	
INCOK	Cochin	India	3.86	0.495	
MYTPP	Tanjong Pelepas	Malaysia	0.04	0.494	Y
INHAI	Haldia	India	0.26	0.494	
INMAA	Chennai (Ex Madras)	India	0.59	0.493	
MYPGU	Pasir Gudang Johor	Malaysia	0.15	0.487	
JPYKK	Yokkaichi Mie	Japan	0.04	0.483	
KEMBA	Mombasa	Kenya	0.30	0.482	
CNCWN	Chiwan (Shenzhen) Guangdong	China	0.04	0.478	
SAYNB	Yanbu	Saudi Arabia	0.22	0.477	
JPNGO	Nagoya Aichi	Japan	0.04	0.475	
OMSLL	Salalah	Oman	4.19	0.460	Y
OMOPQ	Port Sultan Qaboos	Oman	0.19	0.460	Y
OMMFH	Min-Al-Fahal	Oman	0.04	0.460	Y
SAJED	Jeddah	Saudi Arabia	2.41	0.459	
MYPKG	Port Kelang	Malaysia	4.56	0.457	
JPYOK	Yokohama Kanagawa	Japan	0.04	0.457	
INSIK	Sikka (Jamnagar)	India	0.78	0.456	
IRBND	Bandar Abbas	Iran Islamic Republic of	0.19	0.456	
MZBEW	Beira	Mozambique	0.07	0.452	Y
AEDXB	Dubai	United Arab Emirates	3.30	0.450	
INKAK	Kakinada	India	0.11	0.450	Y
INKRW	Karwar	India	0.11	0.450	Y
INHAZ	Hazira	India	0.07	0.450	Y
JOAQJ	Aqaba (El Akaba)	Jordan	0.04	0.450	Y
AEKLF	Khor Al Fakkan	United Arab Emirates	2.67	0.444	
TRDIL	Diliskelesi	Turkey	0.04	0.443	Y
SCPOV	Port Victoria	Seychelles	0.15	0.441	Y
MYPEN	Penang (Georgetown)	Malaysia	0.89	0.436	
INMUN	Mundra	India	0.56	0.435	
YEHOD	Hodeidah	Yemen	0.56	0.433	
SADMN	Damman	Saudi Arabia	0.30	0.429	
MUPLU	Port Louis	Mauritius	0.78	0.426	Y
YEADE	Aden	Yemen	0.52	0.423	
QADOH	Doha	Qatar	0.04	0.422	
YEMKX	Mukalla	Yemen	0.07	0.419	
IRBUZ	Bushehr	Iran Islamic Republic of	0.04	0.417	
BDCGP	Chittagong	Bangladesh	0.19	0.415	
INIXY	Kandla (Muldwarka)	India	5.49	0.415	
AEDAS	Das Island	United Arab Emirates	0.04	0.414	
AESHJ	Sharjah	United Arab Emirates	0.04	0.413	
TRMER	Mersin	Turkey	0.15	0.412	
DJJIB	Djibouti	Djibouti	0.22	0.411	
CYLCA	Larnaca	Cyprus	0.04	0.410	
AEAUH	Abu Dhabi	United Arab Emirates	0.30	0.408	
AEFJR	Fujairah (Al-Fujairah)	United Arab Emirates	3.15	0.402	
KWSAA	Shuaiba	Kuwait	0.11	0.401	
SARTA	Ras Tanura	Saudi Arabia	0.04	0.401	
AEAJM	Ajman	United Arab Emirates	0.07	0.401	Y
QAUMS	Umm Said	Qatar	0.15	0.400	
BHMAN	Manama	Bahrain	0.11	0.397	
BHSIT	Sitra	Bahrain	0.07	0.396	
CYLMS	Limassol	Cyprus	0.04	0.391	
AEJEA	Jebel Ali	United Arab Emirates	6.94	0.391	
AERKT	Ras Al Khaimah	United Arab Emirates	0.04	0.384	Y
THBKK	Bangkok	Thailand	0.07	0.382	
IRBMR	Bandar Mashur	Iran Islamic Republic of	0.04	0.380	
USCHS	Charleston South Carolina	United States	0.04	0.374	
KWKWI	Kuwait	Kuwait	0.15	0.368	
OMMCT	Muscat	Oman	0.48	0.351	Y
IQUQR	Umm Qasr	Iraq	0.07	0.350	Y
IRBKM	Bandar Khomeini	Iran Islamic Republic of	0.11	0.336	
IQMAB	Mina Al Bakir	Iraq	0.04	0.336	Y
ITLIV	Livorno	Italy	0.04	0.335	
IRKHK	Khark Island	Iran Islamic Republic of	0.11	0.331	
ITPSS	Porto Santo Stefano	Italy	0.04	0.330	Y
BJCOO	Cotonou	Benin	0.04	0.317	Y
INCCU	Calcutta	India	0.04	0.299	
SAJUB	Jubail	Saudi Arabia	0.33	0.297	



#### 4.7 Risk species threat

The risk species threat from a BW source port depends on the number of introduced and native species in its bioregion, and their categorisations as unlikely, suspected or known harmful species (Section 3.9). The risk species threat coefficients (C4) for each source port identified for Mumbai-JNP are shown in Figure 23 and listed in Table 7. Table 7 also lists the scores for the introduced, suspected and known harmful species of the source port bioregions, as assigned to the database's species tables by March 2003.

As noted in Section 3.9, these tables and their associated Excel species reference file do not give a complete global list, but provide a working resource enabling convenient update and improvement for each bioregion. Similarly, the 204 bioregions on the GIS world map should not be considered unalterable. Regional resolution of species-presence records is steadily improving in several areas, and this will allow many bioregions to become divided into increasingly smaller units (ultimately approaching the scale of local port waters). It should also be recognised that the distribution of risk species in the database contains a regional bias due to the level of aquatic sampling and taxonomic effort in Australia/New Zealand, Europe and North America. Many of the species listed for these areas can be related to their history of species transfers for aquaculture, plus hull fouling on sailing vessels and the canal-caused invasions of the east Mediterranean (Suez), north-east Europe (Ponto-Caspian river canal links) and Great Lakes (St Lawrence River seaway).

The species in Table 8 include preliminary identifications from the Mumbai-JNP PBBS, plus those listed in published and unpublished reports collated by Group C members (Appendix 5). The regional and often patchy sampling bias needs to be remembered when comparing C4 values between different bioregions, and is a further reason why the independent treatment of C3 for calculating the ROR values is a safer approach (Section 3.10).

Because of the different historical vectors (hull fouling, canals, aquaculture, dry ballast, water ballast, etc), a future version of the BWRA system could provide more accurate C4 values for BW-mediated introduction threats if vector weightings are added to the database for the C4 calculation.

Finally, it is worth noting the database cannot produce 'reverse' C4 values for destination ports (i.e. measures of the relative threat posed by any BW exported from Mumbai-JNP). This requires knowing the sources of all the other BW discharged at each destination port. What can be extracted from the database to assist a 'reverse' BWRA are species assigned to the Mumbai-JNP bioregion, which is CIO-1 (Figure 7, Table 8).

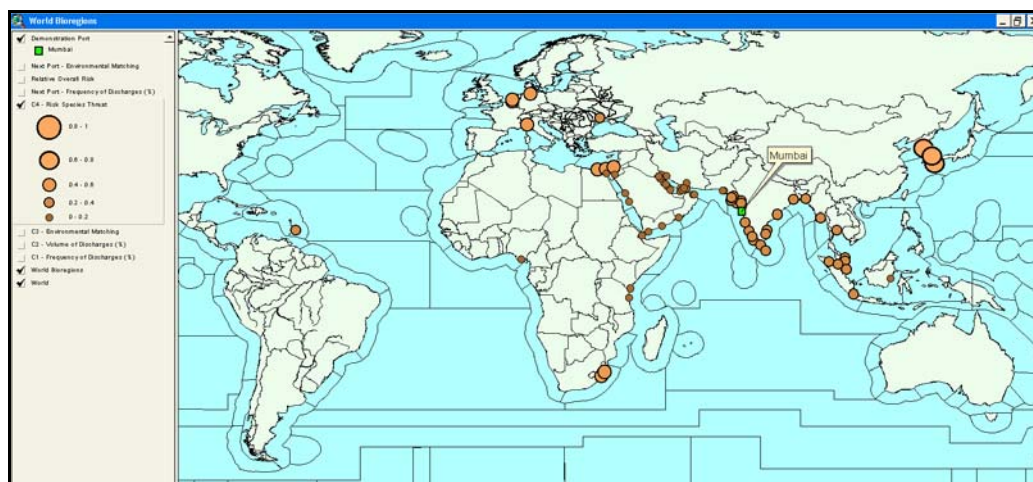

Figure 23. GIS output showing the location and risk species threat coefficients (C4) of the BW source ports identified for Mumbai-JNP

Table 7. Ranking of BW source ports identified for Mumbai-JNP, according to the size of their risk species threat (C4).

Port Code	Source Port	Country	Bio-Region	No. of Introduced Species	Suspected Harmful Species	Known Harmful Species	Total Threat Value	Relative Risk Species Threat (C4)
JPNGS	Nagasaki Nagasaki	Japan	NWP-3a	15	11	12	168	0.600
KRINC	Inchon	Korea Republic of	NWP-4c	15	11	12	168	0.600
KRPUS	Pusan	Korea Republic of	NWP-3a	15	11	12	168	0.600
DKAAB	Aabenraa	Denmark	B-III	39	7	10	160	0.571
BEANR	Antwerpen	Belgium	NEA-II	21	8	10	145	0.518
DEHAM	Hamburg	Germany Federal Republic Of	NEA-II	21	8	10	145	0.518
NLRMT	Rotterdam	Netherlands	NEA-II	21	8	10	145	0.518
ITGOA	Genoa	Italy	MED-II	16	5	11	141	0.504
CYKYR	Kyrenia	Cyprus	MED-V	17	5	10	132	0.471
EGALY	Alexandria (El Iskandariya)	Egypt	MED-V	17	5	10	132	0.471
EGPSD	Port Said	Egypt	MED-V	17	5	10	132	0.471
ILASH	Ashdod	Israel	MED-V	17	5	10	132	0.471
LYKHO	Khoms	Lybian Arab Jamahiriya	MED-IV	17	5	10	132	0.471
ZADUR	Durban	South Africa	WA-V	13	3	9	112	0.400
ZARCB	Richards Bay	South Africa	WA-V	13	3	9	112	0.400
UAILK	Ilyichevsk	Ukraine	MED-IXB	14	5	8	109	0.389
BDCGP	Chittagong	Bangladesh	CIO-III	8	12	5	94	0.336
INCCJ	Calicut	India	CIO-I	8	12	5	94	0.336
INCOK	Cochin	India	CIO-I	8	12	5	94	0.336
INDAH	Dahej	India	CIO-I	8	12	5	94	0.336
INDAM	Daman	India	CIO-I	8	12	5	94	0.336
INHAL	Haldia	India	CIO-III	8	12	5	94	0.336
INHAZ	Hazira	India	CIO-I	8	12	5	94	0.336
INIXE	Mangalore (New Mangalore)	India	CIO-I	8	12	5	94	0.336
INIXY	Kandla (Muldwarka)	India	CIO-I	8	12	5	94	0.336
INKRW	Karwar	India	CIO-I	8	12	5	94	0.336
INMAA	Chennai (Ex Madras)	India	CIO-II	8	12	5	94	0.336
INMRM	Marmugao (Marmagoa)	India	CIO-I	8	12	5	94	0.336
INMUN	Mundra	India	CIO-I	8	12	5	94	0.336
INPAV	Pipavav (Victor) Port	India	CIO-I	8	12	5	94	0.336
INPBD	Porbandar	India	CIO-I	8	12	5	94	0.336
INPNY	Pondicherry	India	CIO-II	8	12	5	94	0.336
INSIK	Sikka (Jamnagar)	India	CIO-I	8	12	5	94	0.336
INTUT	Tuticorin (New Tuticorin)	India	CIO-II	8	12	5	94	0.336
INVAD	Vadinar	India	CIO-I	8	12	5	94	0.336
INVTZ	Visakhapatnam	India	CIO-II	8	12	5	94	0.336
LKCMB	Colombo	Sri Lanka	CIO-II	8	12	5	94	0.336
MMRGN	Yangon (Rangoon)	Myanmar (Former Burma)	CIO-IV	8	12	5	94	0.336
INSTV	Surat	India	CIO-I	8	12	5	94	0.336

**Table 7 (cont'd).** Ranking of BW source ports identified for Mumbai-JNP, according to the size of their risk species threat (C4).

Port Code	Source Port	Country	Bio-Region	No. of Introduced Species	Suspected Harmful Species	Known Harmful Species	Total Threat Value	Relative Risk Species Threat (C4)
IDBLW	Belawan Sumatra	Indonesia	EAS-VI	6	4	5	68	0.243
IDMRK	Merak Java	Indonesia	EAS-VII	6	4	5	68	0.243
MYDGN	Dungun (Kuala Dungun)	Malaysia	EAS-I	6	4	5	68	0.243
MYKUA	Kuantan (Tanjong Gelang)	Malaysia	EAS-I	6	4	5	68	0.243
MYPKG	Port Kelang	Malaysia	EAS-VI	6	4	5	68	0.243
SGSIN	Singapore	Singapore	EAS-VI	6	4	5	68	0.243
THLCH	Laem Chabang	Thailand	EAS-I	6	4	5	68	0.243
MYLUT	Lutong Sarawak	Malaysia	EAS-I	6	4	5	68	0.243
BBBGI	Bridgetown	Barbados	CAR-IV	7	3	4	56	0.200
AEFJR	Fujairah (Al-Fujairah)	United Arab Emirates	IP-1	8	2	4	54	0.193
AEKLF	Khor Al Fakkan	United Arab Emirates	IP-1	8	2	4	54	0.193
OMMCT	Muscat	Oman	IP-1	8	2	4	54	0.193
OMOPQ	Port Sultan Qaboos	Oman	IP-1	8	2	4	54	0.193
PKBQM	Muhammad Bin Qasim	Pakistan	IP-1	8	2	4	54	0.193
PKKHI	Karachi	Pakistan	IP-1	8	2	4	54	0.193
AEFAT	Fateh Terminal	United Arab Emirates	AG-1	4	5	3	49	0.175
IRBND	Bandar Abbas	Iran Islamic Republic of	AG-1	4	5	3	49	0.175
AEAJM	Ajman	United Arab Emirates	AG-5	1	5	3	46	0.164
AEAUH	Abu Dhabi	United Arab Emirates	AG-5	1	5	3	46	0.164
AEDXB	Dubai	United Arab Emirates	AG-5	1	5	3	46	0.164
AEJEA	Jebel Ali	United Arab Emirates	AG-5	1	5	3	46	0.164
AEQIW	Umm Al Qiwain	United Arab Emirates	AG-5	1	5	3	46	0.164
BHMAN	Manama	Bahrain	AG-5	1	5	3	46	0.164
IQMAB	Mina Al Bakir	Iraq	AG-3	1	5	3	46	0.164
IRKHK	Khark Island	Iran Islamic Republic of	AG-3	1	5	3	46	0.164
KWKWI	Kuwait	Kuwait	AG-3	1	5	3	46	0.164
KWMEA	Mina Al Ahmadi	Kuwait	AG-3	1	5	3	46	0.164
QAUMS	Umm Said	Qatar	AG-5	1	5	3	46	0.164
SAJUB	Jubail	Saudi Arabia	AG-3	1	5	3	46	0.164
SARAR	Ras al Khafji	Saudi Arabia	AG-5	1	5	3	46	0.164
SARTA	Ras Tanura	Saudi Arabia	AG-5	1	5	3	46	0.164
OMSLI	Salalah	Oman	OM	6	2	2	32	0.114
EGSUZ	Suez (El Suweis)	Egypt	RS-3	6	0	2	26	0.093
JOAQJ	Aqaba (El Akaba)	Jordan	RS-3	6	0	2	26	0.093
SAJED	Jeddah	Saudi Arabia	RS-2	6	0	2	26	0.093
SAYNB	Yanbu	Saudi Arabia	RS-2	6	0	2	26	0.093
DJJIB	Djibouti	Djibouti	GA	3	2	0	9	0.032
KEMBA	Mombasa	Kenya	EA-III	6	1	0	9	0.032
TZDAR	Dar Es Salaam	Tanzania United Republic Of	EA-III	6	1	0	9	0.032
YEADE	Aden	Yemen	GA	3	2	0	9	0.032
YEMKX	Mukalla	Yemen	GA	3	2	0	9	0.032
IDBPN	Balikpapan Kalimantan	Indonesia	EAS-II	2	2	0	8	0.029
NGBON	Bonny	Nigeria	WA-II	1	0	0	1	0.004

Table 8. Status of risk species assigned to the bioregion of Mumbai-JNP (CIO-I)

Group	Common Name	Species Name	Regional Status	Threat Status
Diatomaceae, Rhizosoleniacea	Polar diatom	<i>Dactylosolen mediterraneus</i> Peragallo	Cryptogenic	Suspected harmful species
Diatomaceae, Rhizosoleniacea	Polar diatom	<i>Peragallo</i>	Cryptogenic	Suspected harmful species
Diatomaceae, Biddulphiaceae	Centric diatom	<i>Chaetoceros curvisetus</i> Cleve	Cryptogenic	Suspected harmful species
Diatomaceae, Coscinodiscoceae	Centric diatom	<i>Coscinodiscus radiatus</i>	Cryptogenic	Suspected harmful species
Diatomaceae, Solenoideae	Centric diatom	<i>Leptocylindrus danicus</i> Cleve	Cryptogenic	Suspected harmful species
Diatomaceae, Coscinodiscoceae	Centric diatom	<i>Skeletonema costatum</i> (Greville) Cleve	Cryptogenic	Known harmful species
Prorocentrates, Prorocentrales	Noxious dinoflagellate	<i>Prorocentrum micans</i> Ehrenberg	Cryptogenic	Suspected harmful species
Peridinales, Gonyaulaceae	Toxic dinoflagellate	<i>Cochlodinium polykrikoides</i>	Cryptogenic	Suspected harmful species
Chlorophyceae	Green algae	<i>Monostroma oxyspermum</i>	Cryptogenic	Not suspected
Silicoflagellatales, Dictyochaceae	Silicoflagellate	<i>Dictyocha fibula</i> Ehrenberg	Cryptogenic	Suspected harmful species
Hydrozoa, Hydroidea	Hydroid	<i>Blackfordia virginica</i>	Cryptogenic	Not suspected
Scyphomedusae	Moon Jellyfish	<i>Aurelia aurita</i>	Cryptogenic	Suspected harmful species
Scyphomedusae	Sea jelly	<i>Phyllorhiza punctata</i>	Native	Not suspected
Polychaeta, Serpulidae	Serpulid tube worm	<i>Ficopomatous enigmaticus</i>	Cryptogenic	Not suspected
Polychaeta, Serpulidae	Serpulid tube worm	<i>Hydroides elegans</i>	Introduced	Known harmful species
Polychaeta, Serpulidae	Serpulid tube worm	<i>Hydroides norvegica</i>	Cryptogenic	Suspected harmful species
Polychaeta, Spionidae	Sedentary spionid worm	<i>Pseudopolydora paucibranchiata</i>	Introduced	Not suspected
Cirripedia, Balanidae	Striped barnacle	<i>Balanus amphitrite amphitrite</i>	Native	Suspected harmful species
Cirripedia, Balanidae	Acorn barnacle	<i>Balanus amphitrite cirratus</i>	Native	Not suspected
Cirripedia, Balanidae	Ivory barnacle	<i>Balanus eburneus</i>	Cryptogenic	Not suspected
Cirripedia, Balanidae	Reticulate barnacle	<i>Balanus reticulatus</i>	Cryptogenic	Not suspected
Cirripedia, Balanidae	Acorn barnacle	<i>Balanus trigonus</i>	Native	Not suspected
Cirripedia, Megabalanidae	Giant barnacle	<i>Megabalanus tintinnabulum</i>	Introduced	Known harmful species
Cirripedia, Megabalanidae	Zebra barnacle	<i>Megabalanus zebra</i>	Cryptogenic	Not suspected
Amphipoda, Ischyroceridae	Sea flea	<i>Jassa marmorata</i>	Introduced	Not suspected
Isopoda, Flabellifera, Limnoriidae	Sea Lice	<i>Cilicæa lateraillei</i>	Cryptogenic	Not suspected
Isopoda, Flabellifera, Cirolanidae	Sea Lice	<i>Cirolana harfordi</i>	Introduced	Not suspected
Isopoda, Sphaeromatidae	Sea Lice	<i>Paradella diana</i>	Introduced	Not suspected
Isopoda, Sphaeromatidae	Sea Lice	<i>Sphaeroma serratum</i>	Cryptogenic	Not suspected
Isopoda, Sphaeromatidae	Sea Lice	<i>Sphaeroma walkeri</i>	Native	Not suspected
Isopoda, Valveria, Idoteidae	Asian slater	<i>Syndotea laevidorsalis</i>	Cryptogenic	Not suspected
Decapoda, Penaeidae	Prawn	<i>Penaeus monodon</i>	Cryptogenic	Not suspected
Decapoda, Portunidae	Swimming crab	<i>Charybdis feriatus</i>	Native	Suspected harmful species
Decapoda, Portunidae	Swimming crab	<i>Charybdis hellerii</i>	Native	Known harmful species
Decapoda, Portunidae	Mud crab	<i>Scylla serrata</i>	Cryptogenic	Not suspected
Bivalvia, Chamidae	Red Sea jewel box	<i>Chama elatensis</i>	Native	Not suspected
Bivalvia, Dreissenidae	Black-striped mussel	<i>Mytilopsis sallei</i>	Introduced	Known harmful species
Bivalvia, Mytilidae	Asian date mussel	<i>Musculista senhousia</i>	Introduced	Known harmful species
Bivalvia, Mytilidae	Indian brown mussel	<i>Perna indica</i>	Cryptogenic	Suspected harmful species
Bivalvia, Mytilidae	Asian Green-lipped mussel	<i>Perna viridis</i>	Cryptogenic	Suspected harmful species
Bivalvia, Ostreidae	Portuguese oyster	<i>Crassostrea angulata</i>	Cryptogenic	Not suspected
Bivalvia, Ostreidae	Indian oyster	<i>Crassostrea gryphoides</i>	Cryptogenic	Not suspected
Bivalvia, Ostreidae	Rock oyster	<i>Saccostrea cucullata</i>	Native	Not suspected
Bivalvia, Teredinidae	Teredinid bivalve	<i>Bankia carinata</i>	Cryptogenic	Not suspected
Bivalvia, Teredinidae	Teredinid bivalve	<i>Bankia gouldi</i>	Cryptogenic	Not suspected
Bivalvia, Teredinidae	Teredinid bivalve	<i>Lyrodus massa</i>	Cryptogenic	Not suspected
Bivalvia, Teredinidae	Teredinid bivalve	<i>Lyrodus medilobata</i>	Cryptogenic	Not suspected
Ascidacea, Styelidae	Sea Squirt (Tunicate)	<i>Eusynstyela tincta</i>	Cryptogenic	Not suspected
Ascidacea, Styelidae	Colonial sea squirt (tunicate)	<i>Phallusia nigra</i>	Cryptogenic	Not suspected
Ascidacea, Styelidae	Sea Squirt (Tunicate)	<i>Styela bicolor</i>	Cryptogenic	Not suspected
Anasca	Sea moss (Bryozoan)	<i>Bugula neritina</i>	Cryptogenic	Not suspected
Anasca	Sea moss (Bryozoan)	<i>Bugula stolonifera</i>	Cryptogenic	Not suspected
Anasca, Electriidae	Sea moss (Bryozoan)	<i>Electra bengalensis</i>	Cryptogenic	Not suspected
Anasca	Sea moss (Bryozoan)	<i>Membranipora tenuis</i>	Cryptogenic	Not suspected
Anasca	Sea Moss (Bryozoan)	<i>Watersipora cucullata</i>	Cryptogenic	Not suspected
Stolonifera, Vesiculariidae	Sea Moss (Bryozoan)	<i>Bowerbankia caudata</i>	Cryptogenic	Not suspected
Stolonifera, Vesiculariidae	Sea moss (Bryozoan)	<i>Bowerbankia gracilis</i>	Cryptogenic	Not suspected
Stolonifera, Vesiculariidae	Sea moss (Bryozoan)	<i>Zoobotryon verticillatum</i>	Cryptogenic	Not suspected
Pedicellinidae, Barentsiidae	Kamptozoon nodding heads	<i>Barentsia ramose</i>	Cryptogenic	Not suspected
Pisces, Eleotriidae	Sleeper goby	<i>Butis koilomatodon</i>	Native	Not suspected
Pisces, Blenniidae	Combtooth blenny	<i>Ornobanchus punctatus</i>	Native	Not suspected

#### 4.8 Risk assessment results

The database calculates the relative overall risk (ROR) of a potentially harmful introduction for all source ports that have C1-C4 coefficients and R1-R2 factors. The ROR value for each source port represents a proportion of the threat posed to the Demonstration Site as result of its contemporary trading pattern (1999-2002).

After calculating the RORs the database generates a large output table listing the source ports and their coefficients, risk-reduction factors and ROR value, plus the five ROR categories used for the GIS plot and the standardised ROR values (S-ROR; Section 3.10). Results from the project-standard BWRA for Mumbai-JNP are listed in Table 9, and the GIS plot of the ROR categories is shown in Figure 24.

From the 3,581 visit records in the Mumbai-JNP database, the project standard identified 11 of the 82 identified source ports as representing the highest risk group (in terms of their BW source frequency, volume, voyage duration, environmental similarity and assigned risk species). These ports, 9 of which were Indian, provided the top 20% of the total ROR, with individual values in the 0.23 - 0.25 range (S-ROR = 0.85 - 1.0; Table 9). The highest risk ports were led by Marmagao and Mangalore, with Colombo a close third and being the first non-Indian port in the ranking (ROR = 0.249; S-ROR = 0.99).

Karachi (Pakistan) was ranked 12<sup>th</sup> as a high risk port with an ROR of 0.23 (S-ROR = 0.85). The highest ranked ports beyond South Asia were firstly Singapore (ranked 10<sup>th</sup> with an ROR = 0.23; S-ROR = 0.93), followed by Nagasaki in Japan (ranked 14<sup>th</sup> as a high risk port (ROR = 0.22; S-ROR = 0.81). The highest ranked port beyond the South and East Asian regions was Durban in South Africa, which was ranked 25<sup>th</sup> with a medium risk ROR of 0.195 (S-ROR = 0.66; Table 9).

The 42 source ports in the low (19) and lowest (23) risk categories were a mixture of cool, hot-saline and/or riverine ports with a wide distribution. The source port with the lowest ROR (0.; S-ROR = 0.0) was the cool freshwater port of Antwerpen in Belgium (ROR = 0.09; Table 9). The frequency distribution of the 82 standardised ROR values is shown in Figure 25.

Based on Mumbai-JNP's current pattern of trade (as implied by the 2000-2002 records), the results suggest that BW from vessels arriving from Europe and the Red Sea/Gulf pose less threat than many ports in India, other South Asian countries and humid East Asian regions.

In fact the take-home message is that Mumbai appears most at risk from relatively local 'port-hopping' by harmful species that establish and acclimate to other Indian or nearby foreign ports, rather than from remote comparable regions such as the Caribbean and Gulf of Mexico. The presence of the East Asian green lipped mussel (*Perna viridis*) and the Caribbean black-striped mussel (*Mytilopsis sallei*) in the navy dock at Mumbai-JNP conform to this conclusion. Thus *Perna viridis* is a tropical mussel native regions that is common in Malay Peninsula and other East Asian ports that regularly trade with Mumbai-JNP. In the case of *Mytilopsis sallei*, this nuisance fouling mussel is believed to have 'port-hopped' from its earlier establishment at Indian ports such as Visakhapatnam, which is a major export port on India's east coast that has more frequent vessel arrivals from Atlantic ports than Mumbai-JNP. It is also worth noting that the BWRA activity is based on two years of shipping data, so that the results can change if there is any major change to the present patterns of Mumbai-JNP trade.

The risk results in Table 9 and plots in Figure 24 appear logical given Mumbai-JNPs biogeographic location and current pattern of trade. They also suggest that the project standard 'first-pass' treatment of the risk coefficients should provide a useful benchmark for exploring the risk formula and refining the database. The indication that Mumbai-JNP is susceptible to unwanted introduced species which establish populations in similar tidal creek/estuarine environment harbours between Karachi and the Pondichery-Visakhapatnam region (on the south-east side of India) could be strengthened by:

- collecting environmental data for ports all ports in this region (to allow their C3 coefficients to be calculated accurately); and
- undertaking PBBS which are targeted at known harmful species in India, in order to elucidate their current distribution pattern and the vectors causing their spread.

Unlike the benthic fouling organisms, none of the noxious phytoplankton species listed in Table 8 for the CIO-I bioregion have clear-cut origins, and some have the potential to increase the incidence and/or severity of red tides within heavily developed, eutrophying coastal systems such as urbanised lagoons, harbours and embayments. Because India is a large tropical/sub-tropical country with a high number of estuarine/lagoonal ports, possible BW mediated transfers of water-borne pathogens (such as cholera) and parasites also needs to be remembered (and their almost virtual absence from the risk species tables of the present database further increases the fragility of the C4 coefficient). Since cholera outbreaks do occur on the Indian subcontinent, running the BWRA with its calculation options tailored to identifying the transfer of unwanted pathogenic strains of *Vibrio* bacteria, and/or other water-borne diseases would be useful for predicting which ports on the subcontinent pose the highest risk to Mumbai-JNP should they report an outbreak, in terms of their shipping and BW trade, voyage duration and environmental similarity.

The ‘port-hopping’ risk mentioned above signifies that India’s domestic port-to-port shipping is an important vector and therefore, as with other large nations such as Australia, warrants active BW management and use of BWRFs, especially to help determine the intra-national pattern of BW transfers. Thus delineation of BW-mediated species invasions and public health risks for any Indian port will need to measure and contrast the influence of domestic arrivals versus international arrivals, together with port proximity (facilitating both natural and BW tank dispersion of organisms), and use of a more port-oriented rather than bioregional approach for the database’s storage and treatment of the risk species data.

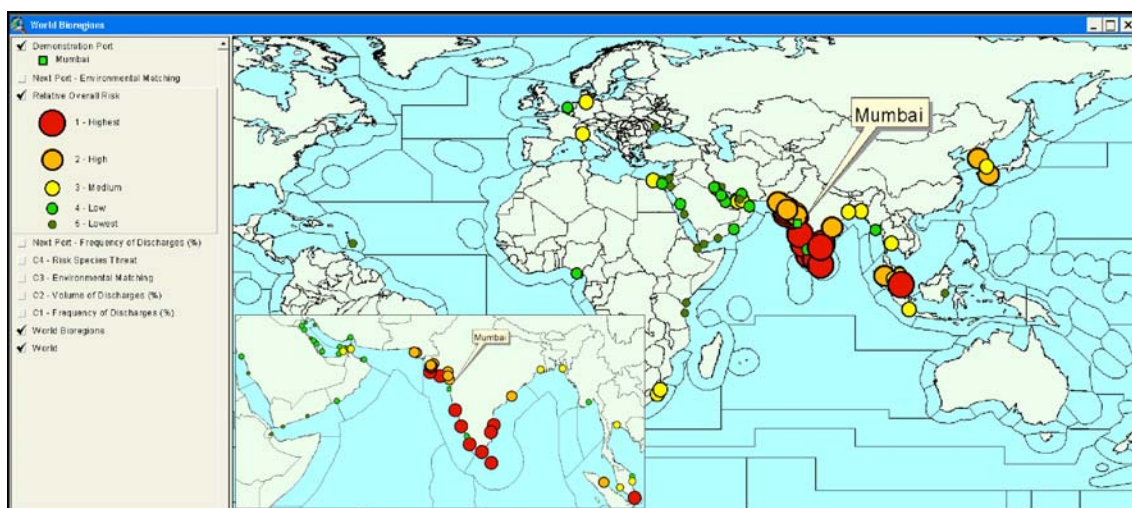

**Figure 24.** GIS outputs showing the location and categories of relative overall risk (ROR) of source ports identified for Mumbai-JNP

**Table 5. BW source ports reported for Mumbai-JNP, ranked according to their Relative Overall Risk (ROR)**

Port Code	Source Port	Country	C1 BW Freq	C2 BW Vol	Max. Tank Disch (MT)	R1	Min. Tank Stor. (d)	R2	C3 Env. Match	C4 Risk Spp.	Relative Overall Risk (ROR)	% of Total Risk				
INMRM	Marmugao (Marmagao)	India	0.0093	0.0366	11,532	1.0	2	1.0	0.624	0.336	0.251	1.83%	1.83%	Highest	1.00	
INIXE	Mangalore (New Mangalore)	India	0.0050	0.0227	9,591	1.0	2	1.0	0.642	0.336	0.251	1.83%	3.65%	Highest	0.99	
LKCMB	Colombo	Sri Lanka	0.1007	0.0174	4,307	1.0	4	1.0	0.542	0.336	0.249	1.81%	5.46%	Highest	0.99	
INISK	Sikka (Jamnagar)	India	0.0261	0.1740	21,600	1.0	2	1.0	0.456	0.336	0.248	1.80%	7.26%	Highest	0.98	
INPNY	Pondichery	India	0.0006	0.0022	5,545	1.0	2	1.0	0.639	Y	0.336	0.244	1.78%	9.04%	Highest	0.96
SGSIN	Tuticorin (New Tuticorin)	India	0.0187	0.0243	10,496	1.0	4	1.0	0.580	0.336	0.240	1.74%	10.8%	Highest	0.93	
INTUT	Cochin	India	0.0224	0.0970	31,956	1.0	2	1.0	0.495	0.336	0.238	1.73%	12.5%	Highest	0.92	
INCOK	Porbandar	India	0.0006	0.0000	80	0.4	1	1.0	0.609	0.336	0.236	1.72%	14.2%	Highest	0.91	
INPBD	Chennai (Ex Madras)	India	0.0292	0.1280	31,278	1.0	5	0.8	0.493	0.336	0.230	1.67%	15.9%	Highest	0.87	
INMAA	Singapore	Singapore	0.1095	0.0812	11,475	1.0	9	0.8	0.530	0.243	0.229	1.66%	17.6%	Highest	0.93	
INPAV	Pipavav (Victor) Port	India	0.0012	0.0002	495	0.6	1	1.0	0.570	Y	0.336	0.227	1.65%	19.2%	Highest	0.85
PKKHI	Karachi	Pakistan	0.1486	0.0284	5,519	1.0	2	1.0	0.535	0.193	0.226	1.64%	20.8%	High	0.85	
JPNGS	Nagasaki Nagasaki	Japan	0.0006	0.0001	287	0.6	15	0.6	0.523	0.600	0.221	1.60%	22.4%	High	0.81	
INVAD	Vadinar	India	0.0031	0.0203	22,468	1.0	1	1.0	0.500	0.336	0.215	1.60%	24.0%	High	0.78	
INIXY	Kandla (Muldwarka)	India	0.0578	0.0466	11,532	1.0	1	1.0	0.415	0.336	0.214	1.55%	25.6%	High	0.77	
INDAM	Daman	India	0.0093	0.0016	426	0.6	0	1.0	0.500	Y	0.336	0.212	1.54%	27.1%	High	0.76
INDAH	Dahej	India	0.0006	0.0001	190	0.6	0	1.0	0.500	Y	0.336	0.209	1.52%	28.6%	High	0.74
INVTZ	Visakhapatnam	India	0.0025	0.0132	10,502	1.0	5	0.8	0.547	0.336	0.208	1.51%	30.1%	High	0.73	
PKBQM	Muhammad Bin Qasim	Pakistan	0.0398	0.0096	895	0.8	2	1.0	0.576	0.193	0.204	1.48%	31.6%	High	0.71	
INHAZ	Hazira	India	0.0031	0.0187	16,731	1.0	2	1.0	0.450	Y	0.336	0.202	1.47%	33.1%	High	0.70
KRINC	Inchon	Korea Republic of	0.0012	0.0002	311	0.6	16	0.6	0.444	0.600	0.201	1.46%	34.5%	High	0.69	
INMUN	Mundra	India	0.0100	0.0217	9,223	1.0	1	1.0	0.435	0.336	0.201	1.46%	36.0%	High	0.69	
IDBLW	Belawan Sumatra	Indonesia	0.0031	0.0006	755	0.8	7	0.8	0.593	0.243	0.198	1.44%	37.4%	High	0.67	
INKRW	Karwar	India	0.0012	0.0006	911	0.8	2	1.0	0.450	Y	0.336	0.197	1.43%	38.9%	High	0.67
ZADUR	Durban	South Africa	0.0025	0.0041	9,104	1.0	12	0.6	0.534	0.400	0.195	1.42%	40.3%	Medium	0.66	
INHAL	Haldia	India	0.0037	0.0054	2,780	1.0	6	0.8	0.494	0.336	0.193	1.40%	41.7%	Medium	0.64	
DEHAM	Merak Java	Indonesia	0.0006	0.0002	388	0.6	7	0.8	0.554	0.243	0.187	1.36%	43.0%	Medium	0.61	
IDMRK	Richards Bay	South Africa	0.0025	0.0129	8,005	1.0	11	0.6	0.477	0.400	0.183	1.33%	44.4%	Medium	0.58	
ZARCB	Laem Chabang	Thailand	0.0025	0.0006	430	0.6	10	0.6	0.574	0.243	0.181	1.31%	45.7%	Medium	0.57	
MYPKG	Genoa	Italy	0.0006	0.0003	635	0.8	14	0.6	0.400	0.504	0.176	1.28%	47.0%	Medium	0.54	
THLCH	Dubai	United Arab Emirates	0.0354	0.0483	16,479	1.0	4	1.0	0.450	0.164	0.175	1.27%	48.2%	Medium	0.53	
ITGOA	Chittagong	Bangladesh	0.0062	0.0057	2,570	1.0	9	0.8	0.415	0.336	0.174	1.26%	49.5%	Medium	0.53	
AEDXB	Alexandria (El Iskandariya)	Egypt	0.0006	0.0003	716	0.8	10	0.6	0.412	0.471	0.174	1.26%	50.8%	Medium	0.53	
BDCGP	Kyrenia	Cyprus	0.0006	0.0015	3,767	1.0	11	0.6	0.410	0.471	0.174	1.26%	52.0%	Medium	0.53	
EGALY	Kuantan (Tanjung Gelang)	Malaysia	0.0006	0.0001	170	0.6	8	0.8	0.494	Y	0.243	0.172	1.25%	53.3%	Medium	0.52
CYKYR	Port Kelang	Malaysia	0.0249	0.0046	3,395	1.0	8	0.8	0.457	0.243	0.170	1.24%	54.5%	Medium	0.58	
MYKUA	Jebel Ali	United Arab Emirates	0.0796	0.0289	7,805	1.0	5	1.0	0.391	0.164	0.166	1.21%	55.7%	Medium	0.48	
AJEJA	Pusan	Korea Republic of	0.0006	0.0001	297	0.6	15	0.6	0.302	0.600	0.166	1.20%	56.9%	Medium	0.48	
KRPUS	Khor Al Fakkan	United Arab Emirates	0.0193	0.0037	1,920	1.0	4	1.0	0.444	0.193	0.165	1.20%	58.1%	Medium	0.47	
AEKLF	Port Sultan Qaboos	Oman	0.0012	0.0001	141	0.6	3	1.0	0.460	Y	0.193	0.164	1.19%	59.3%	Medium	0.46
OMOPQ	Bandar Abbas	Iran Islamic Republic of	0.0087	0.0024	2,455	1.0	4	1.0	0.456	0.175	0.160	1.17%	60.5%	Low	0.44	
IRBND	Fujairah (Al-Fujairah)	United Arab Emirates	0.0354	0.0043	750	0.8	2	1.0	0.402	0.193	0.158	1.15%	61.6%	Low	0.43	
AEFPR	Dungun (Kuala Dungun)	Malaysia	0.0012	0.0001	132	0.6	8	0.8	0.436	0.243	0.158	1.15%	62.8%	Low	0.43	
MYDGN	Fateh Terminal	United Arab Emirates	0.0000	0.0000	0	0.4	4	1.0	0.446	0.175	0.155	1.13%	63.9%	Low	0.41	
AEFAT	Ras al Khafji	Saudi Arabia	0.0000	0.0000	0	0.4	5	1.0	0.437	0.164	0.150	1.09%	65.0%	Low	0.38	
SARAR	Salalah	Oman	0.0100	0.0125	11,219	1.0	4	1.0	0.460	Y	0.114	0.149	1.08%	66.1%	Low	0.38
OMSLI	Abu Dhabi	United Arab Emirates	0.0168	0.0011	193	0.6	4	1.0	0.408	0.164	0.148	1.07%	67.1%	Low	0.37	
AEAUH	Bonny	Nigeria	0.0000	0.0000	0	0.4	13	0.6	0.586	0.000	0.147	1.07%	68.2%	Low	0.36	
NGBON	Suez (El Suweis)	Egypt	0.0012	0.0046	10,678	1.0	9	0.8	0.496	0.093	0.144	1.05%	69.3%	Low	0.34	
EGSUZ	Calicut	India	0.0012	0.0034	5,541	1.0	7	0.8	0.299	Y	0.336	0.143	1.04%	70.3%	Low	0.34
INCCJ	Ummi Said	Qatar	0.0019	0.0060	10,850	1.0	4	1.0	0.400	0.164	0.143	1.04%	71.3%	Low	0.34	
QAUMS	Rotterdam	Netherlands	0.0044	0.0117	10,035	1.0	19	0.6	0.245	0.518	0.143	1.04%	72.4%	Low	0.34	
NLRMT	Ajman	United Arab Emirates	0.0012	0.0001	87	0.4	7	1.0	0.401	Y	0.164	0.142	1.03%	73.4%	Low	0.33
AEAJM	Yangon (Rangoon)	Myanmar (Former Burma)	0.0006	0.0004	1,102	1.0	4	0.8	0.295	0.336	0.141	1.02%	74.4%	Low	0.33	
SARTA	Manama	Bahrain	0.0012	0.0003	630	0.8	4	1.0	0.397	0.164	0.141	1.02%	75.4%	Low	0.32	
MMRGN	Yanbu	Saudi Arabia	0.0012	0.0026	6,111	1.0	7	0.8	0.477	0.093	0.139	1.01%	76.5%	Low	0.31	
KWMEA	Dar Es Salaam	Tanzania United Republic	0.0025	0.0003	262	0.6	8	0.8	0.526	0.032	0.139	1.01%	77.5%	Low	0.31	
BHMAN	Hamburg	Germany Federal Republic	0.0336	0.0097	3,951	1.0	14	0.6	0.201	0.518	0.139	1.01%	78.5%	Low	0.63	
SAYNB	Umm Al Qiwain	United Arab Emirates	0.0050	0.0004	136	0.6	4	1.0	0.384	0.164	0.138	1.00%	79.5%	Low	0.31	
TZDAR	Lufong Sarawak	Malaysia	0.0000	0.0000	0	0.4	7	0.8	0.550	Y	0.000	0.137	1.00%	80.5%	Lowest	0.30
JOAQJ	Surat	India	0.0062	0.0420	23,544	1.0	2	1.0	0.500	Y	0.000	0.137	1.00%	81.5%	Lowest	0.30
AEQWV	Muscat	Oman	0.0019	0.0002	196	0.6	3	1.0	0.351	Y	0.193	0.137	0.99%	82.5%	Lowest	0.30
MYLUT	Ashdod	Israel	0.0006	0.0001	129	0.6	10	0.6	0.262	0.471	0.136	0.99%	83.5%	Lowest	0.30	
INSTV	Jeddah	Saudi Arabia	0.0037	0.0007	740	0.8	7	0.8	0.459	0.093	0.135	0.98%	84.4%	Lowest	0.29	
OMMCT	Aqaba (El Akaba)	Jordan	0.0056	0.0049	9,184	1.0	7	0.8	0.450	Y	0.093	0.134	0.97%	85.4%	Lowest	0.31
ILASH	Mombasa	Kenya	0.0205	0.0057	8,966	1.0	8	0.8	0.482	0.032	0.133	0.97%	86.4%	Lowest	0.28	
SAJED	Ras Tanura	Saudi Arabia	0.0000	0.0000	0	0.4	7	0.8	0.401	0.164	0.133	0.97%	87.3%	Lowest	0.33	
KEMBA	Mina Al Ahmadi	Kuwait	0.0000	0.0000	0	0.4	6	0.8	0.399	0.164	0.133	0.96%	88.3%	Lowest	0.32	
KWKWI	Kuwait	Kuwait	0.0068	0.0011	303	0.6	5	0.8	0.368	0.164	0.127	0.92%	89.2%	Lowest	0.24	
EGPSD	Port Said	Egypt	0.0031	0.0013	2,122	1.0	10	0.6	0.217	0.471	0.126	0.92%	90.1%	Lowest	0.24	
IQMAB	Mina Al Bakir	Iraq	0.0000	0.0000	0	0.4	5	1.0	0.336	Y	0.164	0.125	0.91%	91.0%	Lowest	0.23
IRKHK	Khark Island	Iran Islamic Republic of	0.0006	0.0009	2,303	1.0	4	1.0	0.331	0.164	0.124	0.90%	92.0%	Lowest	0.22	
BBBGI	Bridgetown	Barbados	0.0006	0.0001	307	0.6	26	0.4	0.412	Y	0.200	0.123	0.89%	92.8%	Lowest	0.22
YEADE	Aden	Yemen	0.0274	0.0056	446	0.6	2	1.0	0.423	0.032	0.123	0.88%	93.7%	Lowest	0.21	
SAJUB	Jubail	Saudi Arabia	0.0044	0.0095	4,307	1.0	4	1.0	0.297	0.164	0.119	0.86%	94.6%	Lowest	0.19	
IDBPN	Balikpapan Kalimantan	Indonesia	0.0006	0.0028	6,980	1.0	11	0.6	0.450	Y	0.029	0.118	0.85%	95.4%	Lowest	0.18
DKAAB	Aabenraa	Denmark	0.0006	0.0022	5,347	1.0	22	0.4	0.450	Y	0.000	0.113	0.82%	96.3%	Lowest	0.16
YEMKX	Makalla	Yemen	0.0006	0.0000	49	0.4	4	1.0	0.419	0.032	0.113	0.82%	97.1%	Lowest	0.15	
DJJB	Djibouti	Djibouti	0.0031	0.0006	400	0.6	6	0.8	0.411	0.032	0.110	0.80%	97.9%	Lowest	0.14	
UAULK	Ilyichevsk	Ukraine	0.0006	0.0001	208	0.6	13	0.6	0.179	0.389	0.103	0.75%	98.6%	Lowest	0.10	
LYKHO	Khoms	Lybian Arab Jamahiriya	0.0000	0.0000	0	0.4	12	0.6	0.400	Y	0.000	0.100	0.73%	99.4%	Lowest	0.08
BEANR	Antwerpen	Belgium	0.0006	0.0002	384	0.6	20	0.4	0.143	0.518	0.088	0.64%	100%	Lowest	0.00	

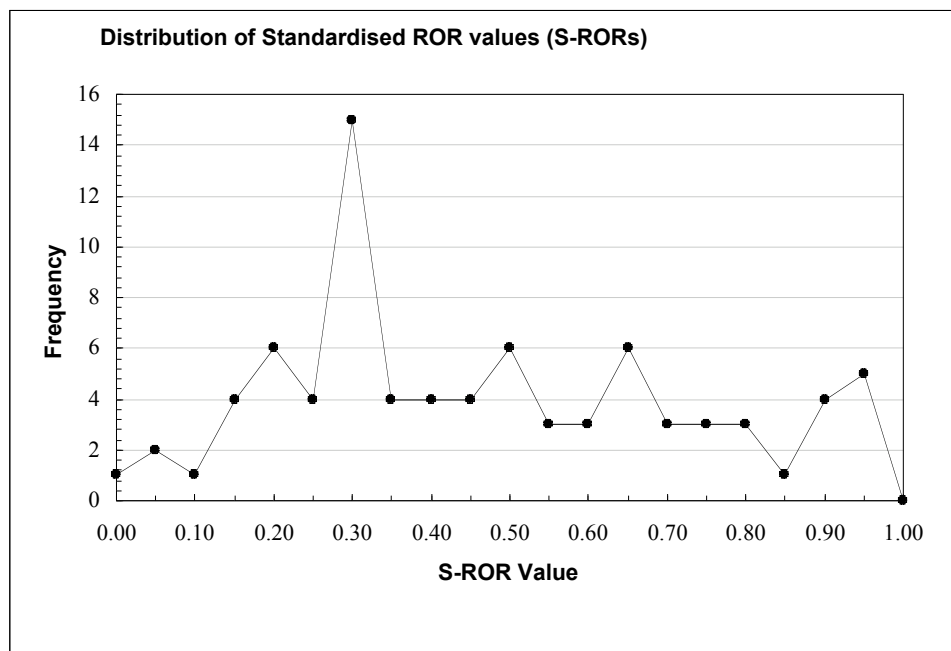

Figure 25. Frequency distribution of the standardised ROR values

### Reverse BWRA

There is no doubt that Mumbai-JNP annually ‘exports’ a considerable volume of ballast water, with most of it being transferred to other ports in relatively small but frequent quantities within the tanks of container ships, general cargo ships, small bulk carriers, ro-ro vessels and vegetable oil (chemical) tankers. If the vessel visit and tank discharge records of the present database is unbiased (i.e. provides a reasonable sample of the present pattern of trade and volume of BW imported per year; ~1 millions tonnes), then using the 2000/2001 ratio of total imported cargo (~21 million tonnes) to exported cargo (~13 million tonnes) produces a crude BW export estimate of ~1.5 million tonnes per annum.

The most frequent destination port appears to be Colombo (Section 4.5). This container hub port has a moderate environmental matching value (0.54) as it experiences a comparable climate regime but is a breakwater harbour located on an open sandy coast without significant tidal creek habitats or major land drainages. This would be expected to limit the range of species which could be successfully transferred from Mumbai-JNP to Colombo harbour with BW. This prediction cannot be drawn for natural embayment, lagoonal/estuarine ports such as Mangalore, Pondichery, Marmagao, Porbandar, Muhammad Bin Qasim and parts of Singapore, all of which are more closely matched with Mumbai-JNP (c.f. Tables 4, 6).

In the case of risk species currently assigned to the Mumbai-JNP bioregion (CIO-I; Table 8), the fouling tube worm, bivalve mollusc and potentially noxious phytoplankton species represent both economically and ecologically harmful species transferred with ballast water uplifted at Mumbai-JNP.

## 4.9 Training and capacity building

The computer hardware and software provided by the GloBallast Programme for the BWRA activity was successfully installed and is currently maintained at the DGS office in Mumbai. This PC, plus others made available by NIO for port map development, database operation and group demonstrations, proved reliable and adequate for running the database, undertaking the similarity analyses, displaying the GIS maps and results and providing other project needs.



Groups A and C contained sufficient number of active counterparts to enable planned training, collation of information and completion of tasks. Group B was hampered by lack of counterparts assigned to support the Group B leader (CFP-A), who was burdened by other Programme duties. While the consultants were able to help search sources and collate shipping record information, and to review, correct, gap-fill and combine visit record entries into a single coherent database, it will be necessary to operate and expand the database and train others on all procedures. This will need the active support and cooperation from Group C counterparts at NIO, plus possible further guidance and assistance from the consultants.

#### **4.10 Identification of information gaps**

##### ***Ballast Water Reporting Forms***

The number and status of the BWRFs collected that were made available for reviewing and checking by the consultants during the 1<sup>st</sup> and 2<sup>nd</sup> visits was limited to approximately 400 forms. Of these, many contained gaps or errors which could be correct and filled, while others provided insufficient data to identify items (date/source/discharge location, etc) to allow reasonable estimations to be added, and therefore had to be rejected.

BWRFs viewed by the consultants that contained many empty or incorrect entries for BW source/s, uptake date/s and tank volumes intended to be discharged were common (approximately 25%; which was similar to other Demonstration Sites where BWRF submissions were gradually implemented on a voluntary basis). It had been planned to conduct an error analysis of the BWRFs during the second country visit, but the lack of available BWRFs and the priority need to expand the database with records derived from MPT terminal shipping records prevented this.

The following list summarises the most common omissions or mistakes in submitted BWRFs that were informally observed and also recorded by other sites:

- BW uptake date, source port/location and/or discharge volume provided for none, one, or only a few of the total number of tanks considered most likely to have been discharged.
- No exchange data in the BW exchange field (Part 4 of the BWRF; Appendix 1), or no reason given for not undertaking an exchange.
- BWRFS showing BW exchange data contained empty BW source cells (it is important to enter the source port/location details because exchanges are often well below 95% effective and never 100%).
- BW Discharge field often ignored or partly filled, even by ships loading a full cargo and therefore discharging most of their ballast.
- “Next Port of Call” occasionally not reported (as BWRFs were being completed and submitted just after arrival, this may be a matter of timing, and this would form an important logistical note for any future ‘reverse’ risk assessment activity).
- BW Exchange in Section 4 - circle one: The ‘Empty/refill or Flow-through’ option had been omitted from the Mumbai and JNP BWRFs. This was brought to the attention of MPT and JNPT during the first consultants visit, with advice for rectification on future issues;
- BW Exchange in Section 4, under “sea height” (waves/swell height) the sea depth in metres is frequently recorded. This reflects simple translation confusions, and a lack of guidance information provided with the BWRFs

The above summary shows which items port officers need to immediately check for when collecting or receiving any BWRF. Unless guidance is provided and errors corrected, ships’ officers, shipping agents and the port officers will take longer to become familiar with and effectively use the BWRF process. Apart from lack of BWRF familiarity, the time provided for a ships’ officer to complete a BWRF is another important factor influencing the number of mistakes and omissions. BWRFs

provided to ships during their berthing or departure phases cannot be expected to receive the same level attention as forms already onboard the ship and completed prior to arrival. Thus reporting can be improved if shipping agents send BWRf reminders (and blank forms where necessary) to ships 1-2 days prior to arrival. Unless BWRfS are completed accurately and fully by vessels visiting Mumbai-JNP, a significant percentage of BW sources and discharge volumes will remain unclear – especially for the general cargo berths at MPT docks and the container and Ro-Ro berths at JNP.

Even with correctly completed forms, it is often impossible to identify the ultimate destination of any BW uplifted by a port that receives and analyses BWRfS (Section 3.5). This is important given the objective of the GloBallast BWRA to identify the destinations of BW uplifted at each Demonstration Site. In fact some of the GloBallast BWRA objectives required considerable effort searching and/or deducing the following information, which is not available from the standard BWRfS:

- Destination Port/s where either BW will be discharged or cargo actually offloaded (not necessarily the Next Port of Call).
- Berth number/location at the reception port (obtained for each Demonstration Site by laborious cross-checking with port records);
- Deadweight tonnage (DWT). This is very useful for checking claimed BW discharge volumes (DWTs were eventually obtained for most ships from the *Lloyds Ship Register*, but this is a time-consuming task, particularly for ships that had entered a new name, incorrect IMO number or Call Sign on the BWRf).

It is therefore recommended that IMO Marine Environment Protection Committee (MEPC) review the standard BWRf with a view to improving its global application under the new BW convention (see Section 5).

#### ***Port environmental and risk species data***

It was particularly difficult to obtain reliable environmental information for a port's waters, particularly for the seasonal water temperature and salinity averages and extrema. This was true for ports in very developed regions (e.g. North America, Europe and Japan) as it was for less developed areas. Most of India's ports are not exceptions to this finding.

In the case of species data, many national and regional data sets remain incomplete and/or unpublished, and there are none published for India or its neighbouring countries. Many sites for North American Caribbean, European, Asian and Australasian regions list species which were historically introduced by the aquaculture, fisheries, aquarium industry or hull fouling vectors, while many do not identify the likely vector/s of their listed species.

## 5 Conclusions and Recommendations

---

The main objectives of the BWRA Activity were completed during the course of this project, which took 13 months (i.e. between the initial briefing in January 2002 and the final consultants visit in February 2003). The level of experience brought to the project by the NIO counterparts facilitated effective instruction and familiarisation of the GIS, Database operation and port environmental and risk species components of the BWRA system.

NIO will be able to provide technical assistance and advice to the Ministry of Shipping for future ballast water risk management projects, and it also wishes to undertake a second BWRA for the Port of Marmagao (for which it already has collated important environmental and risk species data). The NIO will also be able to facilitate India's training and networking plans with other port States in South Asia. In the case of future BWRA projects, however, the Ministry of Shipping will need to strengthen Group B by securing more definitive and formal arrangements with the managers of the selected port/s.

The Regional Strategic Action Plan (SAP) being developed by GloBallast for coordinating BW management activities in the South Asian region can provide an ideal mechanism for replicating the collation and analysis of BWRf data for other ports. Important items requiring attention for any future BW management activity in the South Asian region comprise:

- availability of guidelines and instructions about BWRf reporting to ship's officers, shipping agents and port officers;
- virtual lack of risk species and port baseline biological surveys (PBBSs) in South Asia;
- relative lack of reliable port water temperature and salinity data for the major seasons;
- lack of any regional web-based database for exchanging and updating species survey information.

Port authorities, major national shipping companies and regional maritime organisations in South Asia should be encouraged to support efforts in the above areas.

### 5.1 Recommendations

- To identify the locations where BW is discharged within a port, a more useful BWRf should include an entry for the berth or terminal name/number (instead of simply 'Port' and/or geographic coordinates, which was usually left blank).
- Modifying the "Last Port of Call" field to provide a "Last Three (3) Ports of Call" question would assist BWRf verification checking and analysis for part-loaded vessels visiting multi-use terminals.
- To help decipher and interpret poorly written, incomplete or suspect BWRfs, port and BW database entry officers should have access to up-to-date copies of the *Lloyds Ship Register*, the *Fairplay Ports Guide*, *Lloyd's Maritime Atlas of World Ports* or equivalent publications. For any port using the GloBallast BWRA system, a copy of the world bioregions map should also be provided to the data-entry officers so that the bioregion of any new port added to the database can be quickly identified.
- Any port officer whose duties include collecting or receiving BWRfs should be instructed to check that all relevant fields have been completed in legible script, and to decline any Ballast Water Management Plan offered by the vessel in lieu of a BWRf. A short BWRf information kit and training course provided to port officers and local shipping agents is strongly recommended, particularly during the implementation of the BWRf system at any port.
- Owing to the large number of possible errors and misinterpretations that can be made with the existing IMO-BWRf (particularly if collected by a port on a voluntary basis), there is no

doubt that only people with previous experience or practical knowledge of port and shipping operations make the best BWRf collation and data-entry personnel, and have proved far more easier and cost effective to train during the BWRA projects undertaken for the six Demonstration Sites.

## 5.2 BWRA recommendations and plans by Pilot Country

- The first-pass BWRA indicates that India's domestic port-to-port shipping is an important vector and therefore merits active BW management and use of BWRFs, especially to help determine the intra-national pattern of BW transfers. Future delineation of BW-mediated species invasion and public health risk at any Indian port should measure and contrast the influence of domestic arrivals versus international arrivals (together with port proximity since this facilitates both natural and BW dispersion of organisms), and use more port-oriented approaches for management and treatment of risk species data.
- The current BWRA system does not include vector strength (ballast water vs hull fouling) to help categorize the risk species, and this will form a useful addition in future risk assessments.
- To make future BWRA's more robust, the port environmental data set needs strengthening for all Indian and other South Asian region ports, particularly those for which environmental matching estimates could only be estimated. An appropriate action plan needs to be developed and sustainable funding requirements evaluated.
- Inadequacies in the BWRFs were found to be a major constraint to the assessment objectives and reliability of results. The problem of incomplete and problematic paper BWRFs can be overcome if collation of BW source and discharge data is undertaken via an appropriate electronic reporting system that is purpose-designed to overcome the shortcomings of the present BWRf method.
- An action plan needs to be promulgated to bring key stakeholders (port authorities and trusts) into the realm of BW management in India and other South Asia countries, particularly for the collation of reliable BWRf information and assistance with port environmental data.

## **6 Location and maintenance of the BWRA System**

---

The GloBallast BWRP hardware and software packages in India are presently maintained at the GloBallast Programme office in the Ministry of Shipping (Director General office, Mumbai) and at the NIO in Goa. The following people are currently responsible for maintaining and updating the following features of the BWRA system in India:

### ***Port resource GIS mapping:***

Name: Dr. A.S. Surnarayana  
Organisation: National Institute of Oceanography, Goa  
Organization: National Institute of Oceanography  
Address: Dona Paula, Goa – 403 004, India  
Tel: 91-832-245-0301  
Fax: 91-832-245-0602  
Email:

### ***Ballast water reporting form database:***

Name: Dr Geeta Joshi  
Organization: Directorate General of Shipping, Ministry of Shipping  
Address: Jahaz Bhavan, Walchand Hirachand Marg,  
Mumbai 400 001, India  
Tel: 91-22-2261-3651 (Ext. 303)  
Fax: 91-22-2261-3655  
Email: geeta@dgshipping.com

### ***Database management and operations:***

Name: Mr Venkat Krishnamurthy  
Organization: National Institute of Oceanography  
Address: Dona Paula, Goa – 403 004, India  
Tel: 91-832-245-0380  
Fax: 91-832-245-0602  
Email: kvenkat@darya.nio.org

### ***Port environmental and risk species data:***

Name: Dr A.C. Anil  
Organization: National Institute of Oceanography  
Address: Dona Paula, Goa – 403 004, India  
Tel: 91-832-245-0404  
Fax: 91-832-245-0602  
Email: acanil@darya.nio.org

## References

---

- Carlton, J.T. 1985. Transoceanic and interoceanic dispersal of coastal marine organisms: the biology of ballast water. *Oceanography and Marine Biology Annual Review* 23: pp. 313-371.
- Carlton, J.T. 1996. Biological invasions and cryptogenic species. *Ecology* 77: pp. 1653-1655.
- Carlton, J.T. 2002. Bioinvasion ecology: assessing impact and scale. In: *Invasive aquatic species of Europe: Distribution, impacts and management*. (E Leppäkoski, S Gollasch & S Olenin eds). Kluwer Academic Publishers, Dordrecht, Netherlands, pp. 7-19..
- Cohen, A. & Carlton, J.T. 1995. *Non-indigenous aquatic species in a United States estuary: a case study of the biological invasions of the San Francisco Bay and delta*. Report to the US Fish & Wildlife Service (Washington) and the National Sea Grant College Program Connecticut Sea Grant, December 1995, 211 pp. (from <http://nas.nfreg.gov/sfinvade.htm>).
- Hilliard, R.W., Hutchings, P.A. & Raaymakers, S. 1997a. Ballast water risk assessment for twelve Queensland ports: Stage 4: Review of candidate risk biota. *Ecoports Monograph Series No. 13*. Ports Corporation of Queensland, Brisbane.
- Hilliard, R.W., Walker, S., Vogt, F., Belbin, L. & Raaymakers, S. 1997b. Ballast water risk assessment for twelve Queensland ports, Stage 3B: Environmental similarity analyses. *EcoPorts Monograph Series No. 12*. Ports Corporation of Queensland, Brisbane (two volumes).
- Kelleher, G., Bleakley, C. & Wells, S. 1995. *A Global representative system of marine protected areas*. The World Bank, Washington DC, USA.
- Leppäkoski, E., Gollasch, S. & Olenin, S. 2002. *Invasive aquatic species of Europe: Distribution, impacts and management*. Kluwer Academic Publishers, Dordrecht, Netherlands. 583 pp.
- Williamson, A.T., Bax, N.J., Gonzalez, E. & Geeves, W. 2002. *Development of a regional risk management framework for APEC economies for use in the control and prevention of introduced marine pests*. Final report of APEC Marine Resource Conservation Working Group (MRCWG), produced by Environment Australia, Canberra. 182 pp.



# **APPENDIX 1**

**Copy of**

## **IMO Ballast Water Reporting Form**

**from Resolution A.868(20) Appendix 1**

**(Can be downloaded from <http://globallast.imo.org/guidelines>)**





**Appendix 1 - BALLAST WATER REPORTING FORM (TO BE PROVIDED TO PORT STATE AUTHORITY UPON REQUEST)**

**1. VESSEL INFORMATION**

Vessel Name:	Type:	IMO Number:	Specify Units: m, MT, LT, ST
Owner:	GT:	Call Sign:	Total Ballast Water on Board:
Flag:	Arrival Date:	Agent:	Total Ballast Water Capacity:
Last Port and Country:		Arrival Port:	
Next Port and Country:			

**2. BALLAST WATER**

**3. BALLAST WATER TANKS** BALLAST WATER MANAGEMENT PLAN ON BOARD? YES \_\_\_\_\_ NO \_\_\_\_\_ HAS THIS BEEN IMPLEMENTED? TOTAL NO. OF TANKS ON BOARD \_\_\_\_\_ NO. OF TANKS IN BALLAST \_\_\_\_\_ IF NONE IN BALLAST GO TO NO. 5 YES \_\_\_\_\_ NO \_\_\_\_\_ NO. OF TANKS EXCHANGED \_\_\_\_\_ NO. OF TANKS NOT EXCHANGED \_\_\_\_\_

**4. BALLAST WATER HISTORY:** RECORD ALL TANKS THAT WILL BE DEBALLASTED IN PORT STATE OF ARRIVAL; IF NONE GO TO NO. 5  
 Tanks/Holds (list multiple sources/tanks separately)

BW SOURCE										Flow Through				BW DISCHARGE		
DATE ddmmyy	PORT or LAT. LONG.	VOLUME (units)	TEMP (units)	DATE ddmmyy	ENDPOINT LAT. LONG.	VOLUME (units)	% Exch.	SEA Hgt. (m)	DATE ddmmyy	PORT or LAT. LONG.	VOLUME (units)	SALINITY (units)				

Ballast Water Tank Codes: Forepeak=FP, Aftpeak=AP, Double Bottom=DB, Wing=WT, Topside=TS, Cargo Hold=CH, O=Other

IF EXCHANGES WERE NOT CONDUCTED, STATE OTHER CONTROL ACTION(S) TAKEN: \_\_\_\_\_  
 IF NONE, STATE REASON WHY NOT: \_\_\_\_\_  
 5. IMO BALLAST WATER GUIDELINES ON BOARD (RES. 868(20)) ? YES \_\_\_\_\_ NO \_\_\_\_\_  
 RESPONSIBLE OFFICER'S NAME AND TITLE (PRINTED) AND SIGNATURE: \_\_\_\_\_



# **APPENDIX 2**

## **Risk Assessment Team for Mumbai-JNP, India**



The BWRA team contained three groups which undertook the GIS mapping (Group A), database development (Group B) and environmental matching/risk species (Group C) components of the Activity. The activities of the three groups were coordinated by Dr Arga Chandrashekar Anil Anil (National Institute of Oceanography, Goa) and Dr Rob Hilliard (URS Australia Pty Ltd).

### **Group A (GIS mapping)**

Person: Dr. A.S. Surnarayana  
Position: Group A Leader  
Organization: National Institute of Oceanography  
Address: Dona Paula, Goa – 403 004, India  
Email: surya@darya.nio.org

Person: Mr Chris Clarke  
Position: Group A Counterpart Trainer  
Organization: Meridian GIS Pty Ltd  
Email: chris@meridian-gis.com.au

Person: Mr Andrew Menezes  
Position: Group A – GIS cartographer  
Organization: National Institute of Oceanography  
Address: Dona Paula, Goa – 403 004, India  
Email: amenezes@darya.nio.org

Person: Mr Vibhav V. Joglekar  
Position: Group A – GIS cartographer  
Organization: National Institute of Oceanography  
Address: Dona Paula, Goa – 403 004, India  
Email: vhibav@darya.nio.org

### **Group B (database BW records)**

Person: Dr Geeta Joshi  
Position: Group B Leader – BWRP collation and data entries  
Organization: GloBallast Programme, Directorate General of Shipping Office, Mumbai.  
Email: geeta@dgshipping.com

Person: Mr Terry Hayes  
Position: Group B Counterpart Trainer  
Organization: URS Australia Pty Ltd  
Email: john\_polglaze@urscorp.com

Person: Captain J Misra (Senior Dock Master, JNP)  
Position: Group B –JNPT port record coordinator  
Organization: JNPT Port Authority, Sheva Island, Mumbai.

Person: Captain A.W. Kakare (Dock Master, MPT)  
Position: Group B – MPT port record coordinator  
Organization: Mumbai Port Trust (Port House, S.V.Marg, Ballard Estate, Mumbai 400-001, India)

### **Group C (port environment and risk species data)**

Person: Dr Arga Chandrashekar Anil  
Position: Group C Leader (risk species data collation, regional networking and similarity analysis)  
Organization: National Institute of Oceanography, Dona Paula, Goa, India  
Email: [acani@darya.nio.in](mailto:acani@darya.nio.in)

Person: Dr Robert Hilliard  
Position: Group C Counterpart Trainer  
Organization: URS Australia Pty Ltd  
Email: [robert\\_hilliard@urscorp.com.au](mailto:robert_hilliard@urscorp.com.au)

Person: Mr Venkat Krishnamurthy  
Position: Group C – Risk species data collation and BWRA computer system manager  
Organisation: National Institute of Oceanography, Dona Paula, Goa, India  
Email: [kvenkat@darya.nio.org](mailto:kvenkat@darya.nio.org)

Person: Dr Shubhash S. Sawant  
Position: Group C – Port environmental data collation  
Organisation: National Institute of Oceanography, Dona Paula, Goa, India.  
Email: [sawant@darya.nio.org](mailto:sawant@darya.nio.org)

### **Project Manager**

Steve Raaymakers  
Programme Coordination Unit  
International Maritime Organization  
[sraaymak@imo.org](mailto:sraaymak@imo.org)  
<http://globallast.imo.org>

# **APPENDIX 3**

**Check-list of project requirements  
circulated at initial briefings in January 2001  
(during 3<sup>rd</sup> GPTF meeting, Goa)**





*PROJECT REQUIREMENTS AND PROVISIONAL SCHEDULE*

**REMINDER AND CHECK LIST FOR CFP/CFP-A**

**(1) Confirm your availability of adequate PC hardware, + Windows, Access & peripherals**

**At least** one PC with sufficient processor speed, memory, Windows software and peripherals must be dedicated to the project (plus full-time use during the two visits by the URS Team).

- PC Capability:**
- at least 600 MHz Processor speed
  - at least 10 GB of Hard Disk capacity
  - at least 128 MB RAM
  - 3D Graphics Card with 16 MB of RAM
  - x24 speed CD-ROM drive
  - 21" 16-bit high-colour Monitor (XVGA or higher)
  - a 10/100 base Network Card and 56k modem.

**PC Software:** OS: at least MS Windows 98 (preferably higher).

MS Access: This database program is usually bundled inside MS Office 97 (Business Edition), Office Pro; Office 2000; etc. Please check with your IT people if unsure.

MS Word, MS Excel, MS PowerPoint.

**PC Peripherals:** Convenient access to following peripherals for convenient data inputs and outputs:

- B/W laser printer (>8 pages per minute);
- A3 or A4 colour printer;
- CD Burner
- Flatbed scanner and digitising board
- Semi-auto or auto-archiving system, such as external Zip-Drive, Tape Drive or LAN servers. This is essential for protecting databases from accidental erasures, hard drive crashes, system failures, office fire, burglary, etc.

**(2) Identify Your BWRA Project Team (10 people recommended):**

<b>Required Pilot Country Counterparts</b>	<b>PCU Consultants</b>
BWRA project team leader	Consultants team leader
PC system and GIS operator (x2)	GIS and database specialist
MS Access database operator (x2)	
BWRF and shipping record manager (x2)	Shipping record & port data specialist
Port environmental data searcher (x2)	
Environmental similarity analyst (x2)	BWRA specialist
Risk species networker / biologist	

NB: when selecting team members, please note training will be conducted in English.

- (3) **Check all existing Port GIS, Coastal Resource Atlas, Electronic Charts/Digital Databases** [refer to Briefing Paper - GTPF Agenda Item 4 [*BWRA Action Required*], and the consultants questionnaire provided at Goa (please complete and return a copy)
- (4) **Confirm Dates and Local Arrangements for first consultants visit.**

**Provisional Dates for 1st Visit (5 working days)**

Monday 25 February- Friday 1 March 2002	Odessa, Ukraine
Saturday 2 March- Thursday 7 March 2002	Tehran/Khark Is, I.R. Iran
Monday 11 March- Friday 15 March 2002	Mumbai/Goa, India
Monday 25 March - Friday 29 March 2002	Saldahna, South Africa
Monday 1 April- Friday 5 April 2002	Sepetiba, Brazil
Tuesday 9 April- Saturday 14 April 2002	Dalian, China

**Logistics:** Assistance required for visa applications?  
Customs clearance required for importation of computer software?  
Local transport / work location / office facilities / accommodation

**1<sup>st</sup> Visit Activities:**

- Install and test the ArcView 3.2 GIS package, and the Primer 5 statistical package;
- Commence GIS training by digitising the port map (from any existing digital files, paper charts, maps, habitat information, articles, publications, aerial photos, etc);
- Review all data collated by Country Project Team, including existing databases. Set up the Access database for ship arrival records and the IMO BWRF. Commence training on the Graphic User Interfaces for BWRF inputs
- Collate and review pre-IMO BWRF shipping records to determine source and destination ports, vessel types and trading patterns.
- Review available port environmental data and potential sources of same (see Attachment)
- Commence assembling the risk species list (locate and commence networking with marine biologists in your country and region).
- Identify the critical information gaps.
- Identify the data collating and input work to be completed before the 2<sup>nd</sup> Visit.
- Agree on a provisional date for start of 2<sup>nd</sup> Visit (10 working days).

**2nd Visits (10 work days).** Complete port map digitising; install bioregional map; complete and add risk species to database; perform environmental similarity analysis; undertake risk assessment; evaluate results; review and reporting.

---

---

**Environmental Data Requirements - see next page, attached.**

## ATTACHMENT

### **TYPES OF ENVIRONMENTAL DATA FOR PORT SIMILARITY ANALYSIS**

The project requires two types of port environmental data:

- (A) Charts and marine habitat and resources data are required for the GIS Port Map, and
- (B) A range of parameters (measured in or near port) for the Environmental Similarity Analysis.

In the case of the quantitative parameters, these include:

- Mean water temperature during the summer [monsoon] season (°C)
- Maximum water temperature at the hottest time of the summer [monsoon] season (°C)
- Mean water temperature during the winter [dry] season (°C)
- Minimum water temperature at the coldest time of the winter [dry] season (°C)
  
- Mean day-time air temperature recorded in summer [monsoon] season (°C)
- Maximum day-time air temperature recorded in summer [monsoon] season (°C)
- Mean night-time air temperature recorded in winter [dry] season (°C)
- Minimum night-time air temperature recorded in winter [dry] season (°C)
  
- Mean water salinity during the wettest period of the year (grams/litre; ppt)
- Lowest water salinity at the wettest time of the year (grams/litre; ppt)
- Mean water salinity during the driest period of the year (grams/litre; ppt).
- Highest water salinity at the driest time of the year (grams/litre; ppt).
  
- Mean Spring Tidal range (metres)
- Mean Neap Tide range (metres)
  
- Total rainfall in the port's driest 6 months season (millimetres)
- Total rainfall in the port's wettest 6 months season (millimetres)
- Number of months accounting for 75% of total annual rainfall (=duration of peak discharges)
- Number of kilometres from the berths to the nearest river mouth (negative value if upstream)
- Size of this river's catchment (square kilometres)

[Categorical variables are also required, but these are easy to obtain from charts, maps, articles, etc]



# **APPENDIX 4**

## **Information sources used for collating Port Environmental Data**



Variable	Sources	Provided by/collated from:
Port type	Port plans; hydrographic charts; Fairplay Port Guide 8.4.2; C-Map World for Windows 3.03	Meridian, CFPAs, DMU, E&E, FEEMA, IBSS, MSA, NPA, NIO, PSO, UFP, UFRP
Mean day-time air temperature in warmest season	Buttle & Tuttle Ltd, 2002. World climate data centre (city/town stats). Hilliard et al (1997a)	http://www.worldclimate.com; Meridian GIS.
Maximum day-time air temperature in warm season	NOAA National Climatic Data Centre; Soviet Annals of Meteorological Statistics.	http://www.ncdc.noaa.gov/oa/ncdc.html; IBSS.
Mean night-time air temperature in coolest season	Unpublished NIOC data & IR-Iran Port Statistics;	PSO.
Minimum night-time air temperature in coolest season	Japan Meteorological Agency Climatic Statistics;	http://www.jma.go.jp/JMA_HP/jma/indexe.html; E&E.
Mean water temperature during warmest season	Unpublished ROPME Reports, JICA Reports, KSA-MEP A data	Meridian-GIS; E&E.
Maximum water temperature at warmest time of year	NOAA Nat Env Sat Dat & Inf Serv (NESDIS) 1984-98 monthly mean SST Regional Charts.	http://www.osdpd.noaa.gov/PSB/EPS/ST/atl_climo_mon.html;
Mean water temperature during coolest season	Boyer TP & S Levitus, 1997. Quarter-degree grid objective analysis of world ocean temperature and salinity. NOAA Atlas NESDIS 11.	http://www.nodc.noaa.gov/OC5/README.html
Minimum water temperature at coolest time of year	Interactive monthly mean SST maps, World Oceans Atlases WOA98 and WOA01.	http://www.nodc.noaa.gov/OC5/WOA01F/ssearch.html;
Mean water salinity during wettest period of the year	IRI degree-scale weekly, mean monthly and seasonal SST maps for the Atlantic, Indian and Pacific Oceans for 2002-2003 (International Research Institute for Climate Prediction, Colombia University, Palisades, NY).	http://www.nodc.noaa.gov/OC5/WOA98F/wofaf_cd/search.html
Lowest water salinity at wettest time of the year	IRD (Institut de Recherche de le Development, Centre ORSTOM du Brest) - WOCE monthly SSS and SST maps of the Indian Ocean and tropical Atlantic and Pacific Ocean regions.	http://imgrid.ldgo.columbia.edu/SOURCES/IGOSS/./nmc/weekl y/./sst/
Mean water salinity during driest period of year	Port of San Diego Bay-Wide Water Quality Monitoring Program, 2001.	http://www.brest.ird.fr/ss/climato_oi/ssd_clim1-12.html.
Maximum water salinity at driest time of year	Physical Oceanographic Real Time System [PORTS*] 2001-2003.	Meridian, DMU, FEEMA, IBSS, MSA, NIO, NPA, PSO, UFP.
	Salinity and water temperatures in west side of Galveston Bay, 1982-2002.	http://www.portofsanfrisco.org/sandiego_environment/bsy_wat er_sampling.asp
	Schemel LE, Brown RL & Bell NW, 2003. Salinity and temperature in south San Francisco Bay, California: Results from the 1999-2002 and overview of previous data. USGS Water Resources Investigations Report 03-4005, 37 pp.	http://co-ops.nos.noaa.gov/id_ports.html
	Levitus S, Burgett R & TP Boyer, 1994. World Ocean Atlas 1994 (Vol.3) Salinity. NOAA NESDIS 3, 111 pp.	http://galveston.ssp.nmfs.gov/galv/news/p02/p02_tables.htm
	Levitus S & T Boyer. World Ocean Atlas 1994 (Vol 4) Temperature. NOAA NESDIS 4, 129pp.	http://water.usgs.gov/pubs/wri/wri034005/
	AMBACS Black & Marmara Seas Regional SST and Salinity Maps (AMBACS CD-ROM)	Meridian GIS
	SST and SSS minima and maxima for IUCN Marine Biogeographical Regions.	Meridian GIS
	Docks/ide densities, Fairplay Ports Guide CD 8.4.2 (Lloyds Register Fairplay Ltd, 2001).	IBSS
	World Ocean seasonal mean SSS charts 4.44.1 and 4.44.2 (Jan-Mar & Jul-Sep).	CSIRO Marine Research (Hobart); Campbell & Associates
	Baltic Country Status Reports (Appendix III of Baltic Regional Workshop on BW Management, Tallin 2001) Global Ballast Monograph Series 2 (PCU, IMO London).	Meridian GIS
	Danulat E, Muniz P, Garcia-Alonso J, Yannicelli B, 2002. Mar Poll Bull 44: 554-565.	Meridian GIS
	Walters S (1996). Average maxima and minima SST and seasonal salinities of Australian ports. In: Vic-EPA Publication 494, State Government of Victoria, Melbourne.	Meridian GIS
	Hilliard et al. (1997b). EcoPorts Monograph Series 12, Ports Corporation of Queensland, Brisbn	Meridian GIS
Mean spring tidal range (metres)	Admiralty Tide Tables (Vols 1-4). Hydrographer of Navy, United Kingdom, 1999.	Meridian GIS and PSO
Mean neap tidal R range (metres)	Port tidal ranges, Fairplay Ports Guide CD 8.4.2 (Lloyds Register Fairplay Ltd, 2001).	Meridian GIS and NPA
	Tide Level Predictions, C-Map World for Windows 3.03, C-Map Inc., Norway (2001).	Meridian GIS
Total rainfall during driest 6 months (millimetres)	Buttle & Tuttle Ltd, 2002. World Climate Data Center (city and town statistics) .	http://www.worldclimate.com; http://www.jodc.go.jp/
Total rainfall during wettest 6 months (millimetres)	Japan Oceanographic Data Center.	http://www.ncdc.noaa.gov/oa/ncdc.html; IBSS Odessa;
Fewest months providing 75% of total annual rainfall	NOAA National Climatic Data Center; Soviet Annals of Meteorological Statistics.	Meridian GIS
	Hilliard et al (1997b); Calculated from monthly rain fall data.	Meridian GIS

Continued over...



<p>Distance to nearest river mouth</p> <p>Catchment size of nearest river with significant flow</p> <p>Distance to nearest smooth artificial wall</p> <p>Distance to nearest rocky artificial wall</p> <p>Distance to nearest wood pilings/structures</p> <p>Distance to nearest high tide salt marsh/alkaline flats</p> <p>Distance to nearest sand beach or sand bar</p> <p>Distance to nearest stony/pebble/shingle beach</p> <p>Distance to nearest low tide mud flat</p> <p>Distance to nearest mangroves</p> <p>Distance to nearest natural rocky shore</p> <p>Distance to nearest subtidal firm sands</p> <p>Distance to nearest subtidal soft mud</p> <p>Distance to nearest seagrass meadow</p> <p>Distance to nearest subtidal rocky reef or pavement</p> <p>Distance to nearest coral reef (carbonate framework)</p>	<p>Grand Atlas of India; Atlas of Soviet States (1974); Times Atlas of World; Readers Digest Atlas of Rivers &amp; Lakes; MS Encarta Deluxe Reference Library World Atlas (watershed layer) (2003). C-Map World for Windows 3.03 (river layer) (2001). Atlas of People's Republic of China. Atlases of Africa, Iran, Japan, Korea, South America. Grand Atlas of Japan and North Asia (1996). Heibonsha Cartographic Publishing Co. Ltd, Tokyo.</p> <p>Port plans, hydrographic charts, coastal resource maps, OSCP plans. Saifullah SM, Khan SH &amp; Ismail S, 2002. Mar Poll Bull 44: 570-576.</p> <p>Danulat E, Muniz P, Garcia-Alonso J, Yarnkcell B, 2002. Mar Poll Bull 44: 554-565.</p> <p>National coastal resource maps; Field observations noted on hydrographic charts.</p> <p>Probyn T, Pitcher G, Pienaar R &amp; Nuzziri, 2001. Mar Poll Bull 42: 405-408.</p> <p>Hilliard et al. (1997). EcoPorts Monograph 12, Ports Corporation of Queensland, Brisbane.</p> <p>Unpublished data from National Hydraulic Laboratory, Colombo, Sri Lanka.</p> <p>Red Sea habitat information from Drs H Shalaby &amp; T Roupheal, UNDP program, Cairo.</p> <p>Colour aerial photographs. Landsat thematic images, coastal resource studies (various).</p> <p>Interactive world coral reef distribution maps. Reefbase (UNEP/ICLAR M).</p> <p>Interactive world mangrove distribution map, Reefbase (UNEP/ICLAR M).</p> <p>Seagrass distribution maps (Americas, Asia, Australasia, Europe-Med).</p> <p>McComb, A. et al (1992). Seagrasses of the World. Academic Press, UK.</p> <p>Dusek ML &amp; Kitchens WM, 2003. Vegetation of the Lower Savannah River Delta. Florida Cooperative Fish and Wildlife Unit, University of Florida.</p> <p>Marine habitat maps web-published by the Biodiversity Centre, Nature Conservation Bureau, Ministry of Environment, Japan.</p>	<p>NIO, IBSS, Meridian GIS</p> <p>Meridian GIS</p> <p>Meridian GIS, MSA</p> <p>CSIR, PSO, FEEMA, E&amp;E.</p> <p>CFP-As, CSIR, DMU, E&amp;E, FEEMA, IBSS, IEMA, Meridian GIS, MPT-JNPT, MEPA, MSA, NIO, NPA, PSO, SA, UFP, UFRJ, Meridian GIS.</p> <p><a href="http://www.reefbase.org/Data/photos/dat_gis.asp">http://www.reefbase.org/Data/photos/dat_gis.asp</a></p> <p><a href="http://www.biodic.go.jp/site_map/site.html">http://www.biodic.go.jp/site_map/site.html</a></p> <p><a href="http://www.wec.ufl.edu/coop/Annual_Reports/Marsha%27s%2520poster.ppt">http://www.wec.ufl.edu/coop/Annual_Reports/Marsha%27s%2520poster.ppt</a></p>
<p>Abbreviations: CFP-As; Global Ballast Country Focal Point Assistants; CSIR; Commonwealth Science and Industry Research (Durban Office), South Africa; CSIRO-CRIMP; now CSIRO Marine Research (Hobart). DMU; Dalian Maritime University, Dalian, PR China; E&amp;E; Environmental &amp; Energy Solutions Inc., Kamata, Chuo-ku, Japan; FEEMA; Fundação Estadual de Engenharia do Meio Ambiente, Departamento de Controle Ambiental, Rio de Janeiro, Brazil; IBSS; Institute of Biology of the Southern Seas, Odessa, Ukraine; IEMA; Instituto de Estudos do Mar Almirante Paulo Moreira, Arraial do Cabo, Brazil; JICA; Japan International Cooperation Agency (Tokyo); MEPA; Meteorological and Environment Protection Agency, Saudi Arabia; MPT-JNPT; Port Trusts of Mumbai and Jawaharlal Nehru Ports; MSA; Maritime Safety Authority, Beijing, PR China; NIO; National Institute of Oceanography, Dona Paula, Goa, India; NIOC; National Iranian Oil Company; NPA; National Ports Authority (Saidahma Bay, Richards Bay, Dammam, Kingdom of Saudi Arabia); UFP; Departamento de Botânica, Universidade Federal do Rio de Janeiro, Brazil; UFRP; Departamento de Biologia Marinha, Universidade Federal do Rio de Janeiro, Brazil.</p>		

# **APPENDIX 5**

## **Sources and references of Risk Species information**



- 1 Furlani, D (1996). *Guide to Introduced Species*, CSIRO Marine Research, Hobart, Tasmania (folder-file format).
- 2 McClary DJ & Nelligan RJ, 2001. *Alternate Biosecurity Management Tools for Vector Threats: Technical guidelines for Acceptable Hull Cleaning Facilities*. Research Report No. ZBS 2000/03, prepared by Kingett Mitchell & Associates for New Zealand Ministry of Fisheries, September 2001. 29 pp.
- 2a M. Shaffelke, cited in McClary DJ & Nelligan RJ (2001). [see reference 2]
- 3 Cohen AN & Carlton JT (1995). *Biological study: Non-indigenous aquatic species in a united States estuary: a case study of the biological invasions of the San Francisco Bay and Delta*. US Fisheries & Wildlife National Sea Grant College Program Report PB96-168525. Springfield Virginia, USA. <http://nas.er.usgs.gov/publications/sfinvade.htm>
- 4 Pollard DA & PA Hutchings (1990a,b). A review of exotic marine organisms introduced to the Australian region. I. Fishes (a); and II. Invertebrates and Algae (b). *Asian Fisheries Science* 3: 205-222 (a) and 223-250 (b).
- 4a Wallaston 1968 and Wommersley 1981, cited in Pollard D & Hutchings PA (1990). [see reference 4]
- 4b Skinner & Womersley 1983, cited in Pollard D & Hutchings PA (1990). [see reference 4]
- 4c Allen (1953) - cited in Pollard D & Hutchings PA (1990). [see reference 4]
- 5 Australian NIS lists compiled by CSIRO-CRIMP (1997); CCIMPE (2001); SSC/SCFA (2000)[see reference 23]
- 6 Hutchings PM, Van Der Velde J & S Keable (1989). Baseline survey of the benthic macrofauna of Twofold Bay, NSW, with a discussion of the marine species introduced into the bay. *Proceedings of the Linnaean Society of New South Wales* 110 (4): 339-367.
- 6a Baker, cited by Hutchings et al (1989). [see reference 6]
- 7 Australian Coral Reef Society (1993). *A Coral Reef Handbook* (3rd Edition). Surrey Beatty & Sons Pty Ltd, Chipping Norton NSW, 264 pp.
- 8 Coles SL, DeFelice RC, Eldredge LG and JT Carlton (1997) Biodiversity of marine communities in Pearl Harbor, Oahu, Hawaii with observations on introduced exotic species. *Bernice Pauahi Bishop Museum Technical Report No. 10*: 1-76
- 9 Dakin WJ (1976). *Australian Seashores (Australian Natural Science Library Edition)*. Angus & Robertson, Sydney, 372 pp.
- 10 Carlton JT (1985). Transoceanic and Interoceanic Dispersal of Coastal Marine Organisms: The Biology of Ballast Water. *Oceanogr. Mar. Biol. Ann. Rev.* 23: 313-371.
- 11 Boyd S, Poore GCB & RS Wilson (1996). *Macrobenthic invertebrates of soft sediments in Port Phillip Bay: Introduced Species*. Unpubl. report to CSIRO-CRIMP by Museum of Victoria, Melbourne, 7-96. 122 pp.
- 12 Gosliner TM, Behrens DW & Williams GC (1996). *Coral Reef Animals of the Indo-Pacific - Animal life from Africa to Hawaii exclusive of vertebrates*. Sea Challengers, Monterey CA, 314 pp.
- 13 Wells FE & C Bryce (1988). *Seashells of Western Australia (Revised Edition)*. Western Australian Museum, Perth. 207 pp.
- 14 Tan LWH & PKL Ng (1988). *A guide to the seashore of Singapore*. Singapore Science Centre, Singapore, 159 pp.
- 15 Wells FE & RN Kilburn, 1986. Three temperate-water species of South African gastropods recorded for the first time in southwestern Australia. *Veliger* 28(4): 453-456.
- 16 Gosliner TM (1987). *Guide to the nudibranchs (opisthobranch molluscs) of Southern Africa*. Sea Challengers and Jeff Hamann. Monterey.
- 17 Wasson & Shepherd (1995): cited in Cohen & Carlton (1995) [see reference 3].
- 18 Middleton MJ (1982). The oriental goby, *Acanthogobius flavimanus* (Temminck and Schlegel), an introduced fish in the coastal waters of New South Wales, Australia. *J. Fish Biology* 21: 513-523.
- 19 In: Leppäkoski E, Gollasch S. & S Olenin (eds) (2002). *Invasive aquatic species of Europe: Distribution, impacts and management*. Kluwer Academic Publishers, Dordrecht. 583 pp.
- 20 Morton, B (1981). Biology and functional morphology of *Mytilopsis sallei* (Recluz) (Bivalvia: Dreissenacea) fouling Visakhapatnam Harbour, Andra Pradesh, India. *Journal of Molluscan Studies* 47: 25-42.
- 21 Gollasch, S (2002). Importance of ship hull fouling as a vector of species introductions into the North Sea. *Biofouling* 18: 105-121.
- 22 Hass CG & DS Jones (1999). Marine introductions to western Australia, with a focus on crustaceans. In: Kesby JA, Stanley JM, McLen RF & Olive LJ (eds). *Geodiversity: Readings in Australian Geography at the close of the 20th Century*. Special Publication Series No. 6, School of Geography & Oceanography, University College, Australian Defence Force Academy, Canberra ACT. pp. 37-44.
- 23 Environment Australia (2000). *Joint SCC-SCFA Report of the National Taskforce on the Prevention and Management of Marine Pest Incursions* (October 2000 edition). Environment Australia, Canberra, Australia.
- 24 Domingues Rodrigues M & Al Brossi Garcia (1989). New records of *Pachygrapsus gracilis* (Saussure, 1858) in the Brazilian Littoral. *Cienc Cult San Paulo* 41: 63-66.

- 25 Dadon JR (1984). Distribution and abundance of Pteropoda: Thecostomata (Gastropoda) in the Southwestern Atlantic. *Physis (Buenos Aires)* 42: 25-38.
- 26 Christeffersen ML (1980). Is *Alpheus heterochaelis* Say (Crustacea, Decapoda, Alpheidae) found along the Brazilian coasts? *Review Nordestina Biology* 3: 236-237.
- 27 Galil B & C Golani (1990). Two new migrant decapods from the Eastern Mediterranean. *Crustaceana* 58: 229-236.
- 28 Hanna GD (1966). Introduced molluscs of western North America. *Occasional Papers of Californian Academy of Science* 48: 1-108.
- 29 Yoloye V (1976). The ecology of the West African Bloody cockle, *Anadara (Senilia) senilis* (L.). *Bulletin of the Institute Portdam Africique Noire* (Series A) 38: 25-56.
- 30 Jones DS (1992). A review of Australian fouling barnacles. *Asian Marine Biology* 9: 89-100.
- 31 Wang JJ & ZG Huang (1993). Fouling polychaetes of Hong Kong and adjacent waters. *Asian Marine Biology* 10: 1-12.
- 32 Arakawa KY (1980). On alien immigration of marine sessile invertebrates into Japanese waters. *Marine Fouling* 2: 29-33.
- 33 Carlton J (1999). Molluscan invasions in marine and estuarine communities. *Malacologia* 41(2): 439-454.
- 34 Griffiths CL, Hockey PAR, Van Erkom Shurink C & PJ Le Roux (1992). Marine invasive aliens on South Africa's shores: implications for community structure and trophic functioning. *South African Journal of Marine Science* 12: 713-722.
- 35 Wang C (1995). Some introduced molluscas [sic] in China. *Sinozoologia* 12: 181-191 (in Chinese).
- 36 Cranfield HJ, et al (1998). Adventive marine species in New Zealand. *National Institute of Water and Air Research (NIWA) Technical Report* 34, Auckland, New Zealand, 48 pp.
- 37 Dineen J, 2001. Exotic species reports for Indian River Lagoon, Florida. Smithsonian Fort Pierce website: <http://www.serc.si.edu>
- 38 J Mackie, 2001. Bryozoans at Port of Geraldton, with notes on taxonomy and distribution. In: *Geraldton Port Survey*. Unpublished report to Geraldton Port Authority by the Western Australian Museum, Perth, August 2001.
- 39 Wonham MJ, Carlton JT, Ruiz GM & LD Smith (2000). Fish and ships: relating dispersal frequency to success in biological invasions. *Marine Biology* 136: 1111-1121.
- 40 NIS data for Angola; supplied by Adnan Adawad (GloBallast Programme, Cape Town, South Africa: [adawad@mcm.wcape.gov.za](mailto:adawad@mcm.wcape.gov.za)).
- 41 Dr Tamara Robertson, University of Cape Town (pers. comm.; August 2002).
- 42 Gollasch, S. & Griffiths, C (2000). *Case studies of introduced species in South African waters prepared for the GloBallast Programme*. Report prepared for Globallast Programme; available from Adnan Adawad (GloBallast Programme, Cape Town, South Africa: [adawad@mcm.wcape.gov.za](mailto:adawad@mcm.wcape.gov.za)).
- 43 Draft provisional species list (9/02) from the Saldanha Bay Port Baseline Biological Survey (supplied by Adnan Adawad (GloBallast Programme, Cape Town, South Africa): [adawad@mcm.wcape.gov.za](mailto:adawad@mcm.wcape.gov.za))
- 44 NIS data for Tanzania; supplied by Adnan Adawad (GloBallast Programme, Cape Town, South Africa: [adawad@mcm.wcape.gov.za](mailto:adawad@mcm.wcape.gov.za)).
- 45 NIS data for Mauritius; supplied by Adnan Adawad (GloBallast Programme, Cape Town, South Africa: [adawad@mcm.wcape.gov.za](mailto:adawad@mcm.wcape.gov.za)).
- 46 NIS data for Mozambique; supplied by Adnan Adawad (GloBallast Programme, Cape Town, South Africa: [adawad@mcm.wcape.gov.za](mailto:adawad@mcm.wcape.gov.za)).
- 47 GloBallast Programme (2002). *List of Alien Species*. <http://www.globallast.org>
- 48 Williamson AT, Bax NJ, Gonzalez E & W Geeves (2002). *Development of a regional risk management framework for APEC economies for use in the control and prevention of introduced marine pests*. Final report of APEC Marine Resource Conservation Working Group, produced by Environment Australia, Canberra. 182 pp.
- 49 Walters S, 1996. Ballast water, hull fouling and exotic marine organism introductions via ships - a Victorian study. *Environment Protection Authority of Victoria, Publication 494* (May 1996).
- 50 Pitcher, G (1998). *Harmful algal blooms of the Benguela current*. Colour publication available from Sea Fisheries Research Institute (Private Bag X2, Rogge Bay 8012), Cape Town, Republic of South Africa (20 pp).
- 51 Benson AJ, Williams JD, Marelli DC, Frischer ME & Danforth JM, 2002. Establishment of the green mussel, *Perna viridis*, on the West Coast of Florida. In: *Proceedings of 11th International Conference of Aquatic Invasive species (Feb 25 to March 1, 2002, Washington DC)*. nvironment Department, US Army Engineer & Research Development Laboratory, US.
- 52 Platvoet D, Dick JTA & DW Kelly (2002). Comparative morphometrics of mouthparts and antennae in the invasive *Dikerogammaros villosus* and the native *Gammarus duebeni* (Crustacea, Amphipoda). In: *Proceedings of 11th International Conference of Aquatic Invasive species (Feb 25 to March 1, 2002, Washington DC)*. Environment Department, US Army Engineer & Research Development Laboratory, US.

- 53 Strong JA (2002). Faunal and habitat comparisons from under and outside canopies of *Sargassum muticum*. In: *Proceedings of 11th International Conference of Aquatic Invasive species* (Feb 25 to March 1, 2002, Washington DC). Hosted by Environment Department, US Army Engineer & Research Development Laboratory.
- 54 Verween A (2002). Economic impact of biofouling control of an exotic bivalve, *Mytilopsis leucophaeta*, in the harbour of Antwerp, Belgium. In: *Proceedings of 11th International Conference of Aquatic Invasive species* (Feb 25 to March 1, 2002, Washington DC). Environment Department, US Army Engineer & Research Development Laboratory, US.
- 55 Perry HM, Lukens R, et al, 2002. Invasive species and implications for fisheries sustainability in the Gulf of Mexico. In: *Proceedings of 11th International Conference of Aquatic Invasive species* (Feb 25 to March 1, 2002, Washington DC). Environment Department, US Army Engineer & Research Development Laboratory, US.
- 56 Makarewicz, JC (2002). Distribution, fecundity, genetics and invasion routes of *Cercopafis pengoi* (Ostroumov) - a new exotic zooplankter in the Great Lakes Basin. In: *Proceedings of 11th International Conference of Aquatic Invasive species* (Feb 25 to March 1, 2002, Washington DC). Hosted by Environment Department, US Army Engineer & Research Development Laboratory.
- 57 Bauer CR & Lamberti GA (2002). Potential interactions between Eurasian Ruffe and Round Gobies in the Great Lakes: Prey and habitat differences. In: *Proceedings of 11th International Conference of Aquatic Invasive species* (Feb 25 to March 1, 2002, Washington DC). Environment Department, US Army Engineer & Research Development Laboratory. US.
- 58 Darrigran G *et al* (2002). Abundance and distribution of golden mussel (*Limnoperna fortunei*) larvae in a hydroelectric plant in South America. In: *Proceedings of 11th International Conference of Aquatic Invasive species* (Feb 25 to March 1, 2002, Washington DC). Environment Department, US Army Engineer & Research Development Laboratory, US.
- 59 Personal communications and manuscripts supplied by Dr Andrea Junqueira, Dr Flavio Fernandes, Dr Luciano Felicio Fernandes , Dr Luis Proenca during BWRA workshop at FEEMA, Rio de Janeiro (30 August 2002).
- 60 Fernandes, LF *et al* (2001). The recently established diatom *Coscinodiscus wailesii* in Brazilian waters: taxonomy and distribution. *Phycological Research* 2001.
- 61 Paula, A,F (2002). *Spatial abundance and distribution of invading coral Tubastraea in Ilha Grande Bay (RJ) and record of T. tagusensis and T. coccinea in Brazil*. M.Sc thesis, State University of Rio de Janeiro, May 2002.
- 62 Translated material provided by Assoc Prof. (Biol.) Wang Lijun and Mr Jiang Yuewen (National Marine Environment Protection & Monitoring Centre, State Administration of Oceanography (Dalian Office), China (including preliminary lists of identified species sampled by Port Baseline Biological Survey for Dalian (GloBallast Programme); September 2002).
- 63 Anil AC, Venkat K, Sawant SS, Dileepkumar M, Dhargalkar VK, Ramaiah N, Harkantra SN & ZA Ansari (2002). Marine bioinvasions: Concern for ecology and shipping. *Current Science* 83(3): 214-218.
- 64 K Satyanarya Rao (2002). *Proceedings of 1st R&D Seminar, Global Ballast Water Management Programme*. National Institute of Oceanography, Goa, India. June 2002.
- 65 National Institute of Oceanography (2001). Report released to mass-media (from Dr AC Anil, NIO, Goa).
- 66 Xu, CY (1982). Surveys on the causal organisms of red tides in Dalian Bay. *Journal of Fisheries, China* 6(2): 173-180 (in Chinese).
- 67 Iizuka S (1976). Succession of red tide organisms in Omura Bay with relation to water pollution. *Bulletin of the Plankton Society of Japan* 23(1): 31-43 (in Japanese).
- 68 Kuriakose PS (1980). Mussels (Genus *Perna*) of the Indian coast. In: *Coastal aquaculture of mussels - Progress and Prospects*. Central Marine Research Fisheries Institute (Cochin, India).
- 69 Thompson MF (1994). *Recent developments in biofouling control*. Oxford & IBH Publishing Co, Pty Ltd, UK.
- 70 National Institute of Oceanography: *Bryozoan Identifications* (volume provided by Dr AC Anil, NIO, Goa, India)
- 71 Zaitsev Y & B Ozturk (2001). *Exotic Species in the Aegean, Marmara, Black, Azov and Caspian Seas*. Publication No.8, Turkish Marine Foundation, Istanbul. Turk Deniz Arastirmalari Vakfi. Istanbul.
- 72 CIESM Atlas of Introduced Species in Mediterranean Sea (2002). <http://www.ciesm.org/atlas>
- 73 McMinn, A (1990). Recent dinoflagellate cyst distribution in eastern Australia. *Review of Paleobotany and Palynology* 65: 305-310.
- 74 Karunasagar I, Gowda HSV, Subburaj M, Venugopal MN & I Karunasagar (1984). Outbreak of paralytic shellfish poisoning in Mangalore, west coast of India. *Current Science* 53(5): 247-249.
- 75 Yoon YH *et al* (1991). Red tide organisms in the coastal waters of Cheju Island, southern Korea. *Bulletin of Marine Research Institute, Cheju National University* 15: 1-14.
- 76 Pillai CSG & Jasmine S (1991). Life cycle of *Perna indica*. In: Symposium on tropical marine living resources, Cochin, Kerala (India), 12-16 January 1988. *J. Mar Biol. Association India* 33(1-2): 159-165.

- 77 Coles SL, DeFelice RC & LG Eldredge (1999). Nonindigenous marine species introductions in the harbors of the south and west shores of Oahu, Hawaii. *Bishop Museum Technical Report No. 15* (Bernice Pauahi Bishop Museum, Honolulu, Hawaii).
- 78 Coles SL, DeFelice RC, Eldredge LG & JT Carlton (1999). Historical and recent introductions of non-indigenous marine species into Pearl Harbor, Oahu, Hawaiian Islands. *Marine Biology* 135:147-158.
- 79 Coles SL, DeFelice RC & D Minton (2001). Marine species survey of Johnston Atoll, Central Pacific Ocean, June 2000. *Bishop Museum Technical Report No. 19* (Bernice Pauahi Bishop Museum, Honolulu, Hawaii).
- 80 DeFelice RC, Coles SL, Muir D & LG Eldredge (1998). Investigation of marine communities at Midway Harbor and adjacent lagoon, Midway Atoll, north western Hawaiian Islands. *Bishop Museum Hawaiian Biological Survey Contribution No. 1998-014* (Bernice Pauahi Bishop Museum, Honolulu, Hawaii).
- 81 Hewitt C (2002). Distribution and biodiversity of Australian tropical marine bioinvasions. *Pacific Science* 56(2): 213-222.
- 82 Coles SL & LG Eldredge (2002). Nonindigenous species introductions on coral reefs: a need for more information. *Pacific Science* 56(2): 191-209.
- 83 Hoedt FE, Choat JH, Collins J & JJ Cruz (2000). *Mourilyan Harbour and Abbot Point surveys: Port baseline surveys for introduced marine pests*. Unpubl. report to Ports Corporation of Queensland (Brisbane). School of Marine Biology & Aquaculture, James Cook University, Townsville
- 84 Choo PS, 1994. *A Review on Red Tide Occurrences in Malaysia*. Department of Fisheries, Ministry of Agriculture, Kuala Lumpur, Malaysia.
- 85 Southward AJ, Burton RS, Coles SL, Dando PR, DeFelice R, Hoover J, Newman WA, Parnel E, Yamaguchi (1998). Invasion of Hawaiian inner shores by an Atlantic barnacle. *Marine Ecology Progress Series* 165:119-126.
- 86 Nichols FH, Thompson JK & LE Schemel (1990). Remarkable invasion of San Francisco Bay (California, USA) by the Asian clam *Potamocorbula amurensis*. II. Displacement of a former community. *Marine Ecology Progress Series* 66: 95-101.
- 87 Pyne R (1999). The black-striped mussel (*Mytilopsis salleri*) infestation in Darwin: clean-up strategy. In: *EcoPorts Monograph Series No.19 (77-83)*. Ports Corporation of Queensland, Brisbane.
- 88 Culver, CS (2000). Apparent eradication of a locally established introduced marine pest. *Biological Invasions* 2 (3): 245-253.
- 89 Fofonoff PW, Ruiz GM, Hines AH & L McCann (1999). Overview of biological invasions in the Chesapeake Bay region: summary of impacts on conservation of biological diversity: a key to the restoration of the Chesapeake Bay and beyond. *Monograph. Maryland Department of Natural Resources, pp.168-180*.
- 90 Veldhuizen TC & S Stanish (1999). *Overview of the Life History, Distribution, Abundance, and Impacts of the Chinese mitten crab, Eriocheir sinensis*. Environmental Studies Office, California Department of Water Resources, Sacramento, CA 95816. March 1999.
- 91 NTMAG & CSIRO, 2000. *Port survey of introduced marine species., Port of Darwin*. Unpublished report provided by Dr Barry Russel, Museum & Art Gallery of the Northern Territory, Darwin, Northern Territory, Australia.
- 92 Faunce CH and Lorenz JJ (2000) Reproductive biology of the introduced Mayan cichlid, *Cichlasoma urophthalmus*, within an estuarine mangrove habitat of southern Florida. *Environmental Biology of Fishes* 58: 215–225.
- 93 Zhang F & M Dickman (1999). Mid-ocean exchange of container vessel ballast water. 1: Seasonal factors affecting the transport of harmful diatoms and dinoflagellates. *Marine Ecology Progress Series* 176:243-251.
- 94 Harris LG & MC Tyrell (2001). Changing Community States in the Gulf of Maine: Synergism Between Invaders, Overfishing and Climate Change. *Biological Invasions* 3 (1): 9-21.
- 95 Crooks JA & CA Jolla (2001). Assessing invader roles within changing ecosystems: historical and experimental perspectives on an exotic mussel in an urbanized lagoon. *Biological Invasions* 3 (1): 23-36.
- 96 In: Raaymakers S (Ed.) (2002). Baltic regional workshop on ballast water management, Tallinn, Estonia., 22-24 October 2001: Workshop report. *GloBallast Monograph Series No.2*. IMO, London.
- 97 Gosling EM (1992). Systematics and geographic distribution of *Mytilus*. In: Gosling EM (Ed.) *The Mussel Mytilus: Ecology, Physiology, Genetics and Culture*. Elsevier Press, Netherlands.
- 98 In: Raaymakers S & C Gregory (Eds) (2002). 1<sup>st</sup> East Asia regional workshop on ballast water control and management, Beijing, China. 31 Oct – 2 Nov 2002: Workshop report. *GloBallast Monograph Series No.6*. IMO, London.
- 99 Eno NC, Clark RA & Sanderson WG (Eds). Directory of non-native marine species in British waters. <http://www.jncc.gov.uk/marine/dns/default.htm>
- 100 Oderbrecht et al (2002).
- 101 Ports & Shipping Organisation (2002). Species tables. In: *Draft report of seasonal Port Baseline Biological Surveys for Port of Khark Island*. Unpublished manuscript provided by PSO, Tehran, I.R. Iran.

- 102 Introduction to non-indigenous species of the Gulf of Mexico (2002). Website: [http://www.gsmfc.org/nis/nis/Perna\\_perna.html](http://www.gsmfc.org/nis/nis/Perna_perna.html)
- 103 Erkki Leppäkoski E & S Olenin (2000). Non-native species and rates of spread: Lessons from the brackish Baltic Sea. *Biological Invasions* 2 (2):151-163.
- 104 Ambrogi AO (2000). Biotic invasions in a Mediterranean lagoon. *Biological Invasions* 2 (2): 165-176
- 105 Galil BS (2000). A sea under siege – alien species in the Mediterranean. *Biological Invasions* 2 (2):177-186
- 106 Mann, R (2000). Invasion of the North American atlantic coast by a large predatory Asian mollusc *Biological Invasions* 2(1): 7-22
- 107 Lohrer AM, Whitlatch RB, Wada K & Y Fukui (2000). Home and away: comparisons of resource utilization by a marine species in native and invaded habitats. *Biological Invasions* 2 (1):41-57
- 108 Wasson, K & B Von Holle (2000). Detecting invasions of marine organisms: Kamptozoa case histories. *Biological Invasions* 2(1): 59-74.
- 109 Rivest BR, Coyer J, Haren AA & S Tyler (1999). The first known invasion of a free-living marine flatworm. *Biological Invasions* 1(4): 393-394
- 110 Exotic species list of the Monterey Bay National Marine Sanctuary. <http://bonita.mbnms.nos.noaa.gov/sitechar/spex.html>
- 111 FAO database on aquatic species introductions: <http://www.fao.org/waicent/faoinfo/fishery/statist/fisoft/dias/index.htm>
- 112 Global Invasive Species Program (GISP): <http://jasper.stanford.edu/GISP/> and GISP Database: <http://www.issg.org/database/welcome/>
- 113 Group on Aquatic Alien Species (GAAS) (Russia): <http://www.zin.ru/projects/invasions/index.html>
- 114 Gulf of Maine Ballast Water and Exotic Species Web Sites: <http://www.gulfofmaine.org/library/exotic.htm>
- 115 Gulf of Mexico Program Nonindigenous Species Information: <http://pelican.gmpo.gov/nonindig.html>
- 116 Smithsonian Environmental Research Center (SERC marine invasions lab): <http://invasions.si.edu/>
- 117 Ecological Society of Japan (Ed.) (2002). *Handbook of alien species in Japan*. (published 9/02). Chijinshokan Ltd, Tokyo (in Japanese). 390pp. <http://www.chijinshokan.co.jp>
- 118 Fine M, Zibrowius H & Y Loya (2001). *Oculina patagonica*: a non-lessepsian scleractinian coral invading the Mediterranean Sea. Springer-Verlag (New York): <http://linl.springer-ny.com/link/service/journals/00227/contents/01/00539/>
- 119 Schaffelke B, Murphy N & S Uthicke (2002). Using genetic techniques to investigate the sources of the invasive alga *Caulerpa taxifolia* in three new locations in Australia. *Mar Poll Bull* 44: 204-210.
- 120 Washington State Sea Grant Program: Non-indigenous aquatic species: <http://www.wsg.washington.edu/outreach/mas/nis/nis.html>
- 121 Baltic Research Network on invasions and introductions (NEMO). Website: <http://www.ku.lt/nemo/mainnemo.htm>
- 122 US Geological Service non-indigenous aquatic species (NIAS) website: <http://nas.er.usgs.gov/>
- 123 National aquatic nuisance species clearing house - Seagrant Program: <http://www.entryway.com/seagrant/>
- 124 Esmaili Sari A, Khodabandeh S, Abtahi B, Sifabadi J & H Arshad (2001). *Invasive comb jelly Mnemiopsis leidyi and the future of the Caspian Sea*. Faculty of Natural Resources and Marine Sciences, University of Tarbiat Modarres. Kor, Mazandaran, IR Iran. ISBN: 964-91086-2-9. (+95 pp; non-English). Obtainable from: [yavarivahid@hotmail.com](mailto:yavarivahid@hotmail.com) ; [yavari@ir-pso.com](mailto:yavari@ir-pso.com) .
- 125 Cohen BF, Heislors S, Parry GD, Asplin MD, Werner GF & JE Restall (2002). *Exotic marine pests in the outer harbour of the Port of Adelaide*. Marine and Freshwater Resources Institute of Victoria (Report No. 40), MAFRE, Queenscliffe, Victoria, Australia. (9/02; 86pp.).





# **APPENDIX 6**

**Name, UN code, coordinates and environmental parameters of the 357 ports used for the multivariate similarity analyses for all Demonstration Sites**



Port Environmental Data - Input file used for PRIMER Analysis	UN Port Code	Latitude		Longitude		Port Type	Water Temperatures (°C)				Summer Air Temp°C [SART]		Winter Air Temp °C [WART]		Salinities (g/L) [SAL]			Tidal Ranges (m)					
		Deg	Min	S	N		Deg	Min	W	E	Mean Summer	Maximum Summer	Mean Winter	Lowest Winter	Mean day-time	Maximum daytime	Mean night-time	Lowest night-time	Mean in Wet period	Lowest in Wet period	Mean in Dry period	Max in Dry period	Mean Springs
Name of Port	CODE	LAT	LONG	W	E	PITYPE	MSUWT	USUWT	MMNWT	LWNWT	MSART	USART	MMWART	LWMART	MWSAL	LWSAL	MDSAL	UDSAL	MSPR	MNER			
Abu Dhabi	AEAUH	24	32.0	N	54	23.0	E	3	30.5	35.5	21.0	16.0	19.0	8.0	38.0	38.0	39.5	42.0	1.6	0.4			
Mina Zayed	AEAMZ	24	32.0	N	54	23.0	E	3	30.5	35.5	21.0	16.0	19.0	8.0	38.0	38.0	39.5	42.0	1.6	0.4			
Das Island	AEDAS	25	9.0	N	52	52.0	E	1	30.0	35.2	22.5	16.9	31.0	42.0	38.0	37.5	39.0	40.5	0.6	0.2			
Port Rashid	AEPRA	25	16.0	N	55	16.0	E	3	30.5	34.6	23.0	16.0	33.0	47.0	38.5	37.0	40.0	42.0	2.1	0.3			
Dubai	AEDXB	25	16.0	N	55	16.0	E	3	30.5	34.6	23.0	16.0	33.0	47.0	38.5	37.0	40.0	42.0	2.1	0.3			
Fateh Oil Terminal	AEFAT	25	36.0	N	54	31.2	E	1	30.0	35.2	22.5	16.9	31.0	42.0	38.0	37.5	39.0	40.5	0.8	0.2			
Fujairah	AEFJR	25	10.0	N	56	21.0	E	1	30.0	32.0	22.0	16.5	32.8	40.0	35.5	35.0	36.0	37.0	1.8	1.0			
Jebel Ali	AJEJA	25	0.0	N	55	3.0	E	3	30.0	34.6	21.0	16.0	31.0	47.0	38.5	37.0	40.0	42.0	1.1	0.2			
Jebel Dhanna	AJEDA	24	12.0	N	52	40.0	E	1	30.0	35.2	22.5	16.9	31.0	42.0	38.0	38.0	39.5	41.0	0.8	0.2			
Khor Al Fakkan	AEKLF	25	24.0	N	56	22.0	E	1	30.0	32.0	21.5	16.5	32.8	42.0	24.0	14.0	35.5	36.0	37.0	1.8	1.0		
Um Al Qiwain	AEOIW	25	36.0	N	55	37.0	E	4	30.0	34.6	21.0	16.0	31.0	47.0	38.5	37.0	40.5	42.0	1.1	0.6			
Ruwais Oil Terminal	AERUW	24	7.8	N	52	43.8	E	1	30.0	35.2	22.5	16.9	31.0	42.0	38.0	38.0	39.5	41.0	0.8	0.2			
Sharjah	AESHJ	25	22.0	N	55	23.0	E	3	30.5	34.6	23.0	16.0	33.0	47.0	38.5	37.0	40.0	42.0	2.1	0.2			
Zirku Island	AEZIR	24	52.2	N	53	4.2	E	1	30.0	35.2	22.5	16.9	31.0	43.0	38.0	37.5	39.0	40.5	0.8	0.2			
Buenos Aires	ARBUE	34	34.0	S	58	23.0	W	5	24.0	27.0	15.0	13.0	26.0	34.0	5.0	0.0	10.0	15.0	25.0	1.3	0.6		
Campagna	ARCMP	34	9.0	S	58	58.2	W	6	24.0	27.0	15.0	13.0	26.0	35.0	4.0	0.0	0.0	0.0	0.0	0.0	0.0	0.0	
Dampier	AUDAM	20	39.0	S	116	43.0	E	4	26.5	31.0	23.0	19.0	36.0	45.0	14.0	7.0	34.8	34.1	35.1	35.5	5.6	2.8	
Port Walcott (Cape Lambert)	AUPWL	20	37.0	S	117	11.0	E	1	26.5	31.0	23.0	20.0	36.0	45.0	14.0	7.0	34.9	33.8	35.1	35.5	6.0	2.9	
Port Bonython	AUPRY	33	1.0	S	137	46.0	E	2	20.0	22.0	14.5	12.0	27.0	35.0	7.5	1.0	36.1	36.0	36.2	36.3	2.6	1.6	
Whyalla	AUWYA	33	1.8	S	137	24.0	E	3	19.5	21.5	14.5	12.0	26.0	36.0	5.8	0.5	35.4	35.1	35.5	35.8	2.3	1.6	
Port Pirie	AUPPI	33	10.2	S	138	1.8	S	2	20.0	21.5	14.5	12.0	26.0	36.0	5.8	0.5	36.5	36.6	37.2	38.0	2.7	1.7	
Port Stinvec	AUPST	35	6.0	S	138	28.0	E	1	20.5	22.0	14.5	13.0	26.0	38.0	14.0	3.0	36.3	36.8	36.4	36.5	2.1	1.4	
Western Port (now Hastings, AUHAS)	AUWEP	38	18.0	S	145	13.2	E	1	18.0	20.0	13.5	11.0	25.2	34.0	6.5	-4.0	35.3	35.0	35.4	35.5	3.3	2.2	
Port Kembla	AUPKL	34	28.2	S	150	54.0	E	3	18.5	21.0	17.5	15.0	25.0	36.0	8.8	0.0	34.5	32.0	35.2	35.6	2.0	1.1	
Brisbane	AUBNE	27	22.8	S	153	9.6	E	5	24.0	27.0	20.0	17.5	29.2	39.0	9.0	2.0	26.0	4.0	33.0	35.0	2.3	1.3	
Bundaberg	AUBDB	24	46.0	S	152	23.0	E	5	25.7	29.2	19.8	15.7	29.0	36.6	16.0	5.1	35.1	25.0	35.4	36.0	2.4	1.2	
Gladstone	AUGLT	23	51.0	S	151	15.0	E	4	26.0	28.5	22.0	20.0	31.0	39.0	14.0	8.0	34.1	31.0	35.2	35.5	4.0	1.7	
Port Alma	AUPTL	23	35.0	S	150	52.0	E	5	26.8	28.7	21.1	19.5	26.0	39.1	11.0	6.0	30.0	20.0	35.0	36.0	4.0	1.9	
Hay Point	AUHPT	21	16.0	S	149	19.0	E	1	27.0	30.0	21.5	19.0	25.0	36.6	14.0	6.7	34.9	33.0	35.3	36.5	4.8	2.2	
Dallrymple Bay (= Hay Point Anchorage)	AUDPT	21	16.2	S	149	19.2	E	1	27.0	30.0	21.5	19.0	25.0	36.6	14.0	6.7	34.9	33.0	35.3	36.5	4.8	2.2	
Mackay	AUMKY	21	6.0	S	149	20.0	E	3	26.2	31.0	19.5	18.0	30.5	36.6	14.8	6.7	35.0	31.0	35.3	36.5	4.5	2.1	
Abbot Point	AUABP	19	53.0	S	147	5.0	E	1	28.4	32.4	23.4	19.3	31.0	37.4	18.0	9.4	34.7	24.3	35.3	36.5	2.0	0.8	
Townsville	AUTSV	18	31.0	S	146	50.0	E	3	28.2	32.4	23.0	19.0	31.5	40.8	15.5	6.0	34.7	22.0	35.0	36.2	2.3	0.6	
Lucinda	AULUC	18	15.0	S	146	19.0	E	1	28.0	31.0	24.0	21.0	31.0	37.0	18.0	14.5	34.4	20.0	35.0	37.0	2.2	0.6	
Mouilyan	AUMOU	17	37.0	S	146	7.0	E	5	30.0	33.0	27.0	23.0	31.0	39.5	18.0	8.4	33.0	9.0	35.0	36.0	1.8	0.5	
Cairns	AUCNS	16	55.0	S	145	47.0	E	4	27.0	31.0	23.6	18.5	32.0	39.3	17.5	9.2	34.4	5.0	35.0	36.0	1.8	0.4	
Cape Flattery	AUCDP	14	59.0	S	145	21.0	E	2	28.0	30.0	24.0	21.0	31.0	39.4	22.0	11.3	33.6	32.0	35.0	35.5	1.7	0.4	
Wreipa	AUWEI	12	35.0	S	141	36.0	E	5	30.0	33.0	28.5	24.0	33.0	37.0	19.2	12.5	33.0	20.0	35.0	36.0	2.2	0.7	
Kaumba	AUKRB	17	29.0	S	140	50.0	E	6	30.0	32.0	28.0	24.0	32.0	38.0	18.5	14.2	24.0	0.0	35.0	39.0	3.3	2.5	
Chittagong	BDCGP	22	13.0	N	91	48.0	E	5	29.0	32.4	25.0	19.0	30.0	33.0	19.0	13.0	2.0	0.0	7.0	12.0	4.9	2.1	
Anwerpem	BEANR	51	14.0	N	4	28.0	E	6	17.0	20.0	6.0	0.0	21.5	30.0	2.2	-4.0	0.0	0.0	0.0	0.0	0.0	0.0	0.0
Ghent (Gent)	BEGNE	51	4.2	N	3	42.0	E	6	17.0	20.0	6.0	0.0	21.0	26.0	1.8	-5.0	0.0	0.0	0.0	0.0	0.0	0.0	0.0
Bourgas	BGBOJ	42	30.0	N	27	28.8	E	3	24.2	26.5	6.5	0.5	24.5	38.0	4.3	-16.0	17.0	16.4	18.1	19.5	0.1	0.0	
Varna Bulgaria	BGVAR	43	12.0	N	27	57.0	E	3	21.7	25.9	5.9	-0.5	24.0	38.0	3.5	-17.0	16.8	16.1	17.9	19.3	0.1	0.0	
Sitra (Bahrain)	BHMAN	26	9.0	N	50	40.0	E	1	32.0	35.0	17.0	14.0	36.5	45.0	18.0	12.0	40.0	38.0	42.0	43.0	1.6	0.9	
Mina Sulman (Al Manamah)	BHMIN	26	13.0	N	50	36.0	E	3	32.0	35.0	17.0	14.0	36.5	45.0	18.0	12.0	40.0	38.0	42.0	43.0	1.6	0.9	
Itajaí	BRITJ	26	54.0	S	48	39.7	W	6	26.2	28.0	19.1	17.5	23.0	30.6	17.6	1.3	3.0	0.0	4.9	15.0	1.2	0.3	
Paranaquá	BRPNG	25	30.1	S	48	31.5	W	5	27.5	30.0	21.4	13.0	22.0	40.0	17.2	2.4	20.5	10.5	27.0	34.0	1.6	0.4	
Santos	BRSSZ	23	55.0	S	46	20.0	W	4	26.5	30.5	21.5	17.0	23.7	39.0	19.0	6.4	38.0	24.0	28.5	33.5	1.3	0.4	
Sepeiba	BRSPB	22	55.3	S	43	51.0	W	2	22.0	25.5	19.0	17.2	25.4	38.2	22.0	11.1	30.5	20.0	30.5	34.0	1.4	0.7	
Rio de Janeiro	BRRIO	22	53.8	S	43	11.0	W	2	27.5	31.0	23.4	19.0	25.4	38.2	22.0	11.1	30.5	20.0	30.5	34.0	1.4	0.7	
Ponta do Ubu	BRPOU	20	47.0	S	40	35.0	W	1	24.0	27.0	23.0	21.0	25.8	39.0	22.7	14.2	36.0	35.0	37.0	39.0	1.4	0.6	
Victoria	BRVIX	20	19.2	S	40	19.1	W	5	25.0	28.0	22.0	20.0	25.8	39.0	22.7	14.2	20.5	12.0	27.0	34.0	1.3	0.5	
Praia Mole	BRPRM	20	17.3	S	40	14.5	W	3	24.0	27.0	23.0	21.0	25.8	39.0	22.7	14.2	36.0	35.0	37.0	39.0	1.3	0.4	
Tubarao	BRTUB	20	17.3	S	40	14.6	W	3	24.0	27.0	23.0	21.0	25.8	39.0	22.7	14.2	36.0	35.0	37.0	39.0	1.3	0.4	

Port Environmental Data - Input file used for PRIMER Analysis	UN Port Code	Latitude		Longitude		E	Port Type	Water Temperatures (°C)				Summer Air Temp (SART)		Winter Air Temp (WART)		Salinities (g/L)			Tidal Ranges (m)	
		Deg	Min	S	Deg			Min	W	Mean Summer	Maximum Summer	Mean Winter	Lowest Winter	Mean day-time	Maximum daytime	Mean night-time	Lowest night-time	Mean in Wet period	Lowest in Wet period	Mean in Dry period
Name of Port	CODE	LAT	LONG	PTYPE	MSUWT	USUWT	MWWT	LWNWT	MSART	USART	MWART	LWART	MWSAL	LWSAL	MDSAL	UDSAL	MSPR	MNER		
Salvador	BRSSA	12 58.4	S	38 31.0	W	2	26.5	30.2	25.2	19.5	24.3	19.8	36.0	35.0	37.0	39.0	2.2	0.9		
Come By Chance	CACBC	47 28.8	N	54 0.6	W	2	16.0	17.0	2.0	2.0	-2.0	-12.0	31.0	31.0	32.0	32.5	2.6	1.7		
Sept-iles (Pointe Noire) Quebec	CASEI	50 11.0	N	66 23.0	W	2	11.0	13.0	-1.0	-6.0	-17.0	-30.0	26.0	24.0	28.0	30.0	3.5	1.6		
Halifax Nova Scotia	CAHAL	44 39.0	N	63 34.0	W	2	14.5	16.0	2.0	-0.5	-8.0	-20.0	30.0	29.0	31.0	32.0	2.0	1.3		
La Have	CALHA	44 17.0	N	64 21.0	W	5	11.0	13.0	2.0	-2.0	-8.0	-20.0	25.0	15.0	29.0	31.0	2.1	1.6		
Vancouver (British Columbia)	CAVAN	49 16.8	N	123 7.2	W	5	11.0	13.0	3.0	-1.0	21.2	-4.0	10.0	2.0	24.0	28.0	4.1	3.4		
Roberts Bank (British Columbia)	CARBK	49 2.0	N	123 9.0	W	5	11.0	13.0	3.0	-1.0	21.2	-4.0	10.0	2.0	24.0	28.0	4.1	3.4		
Guangzhou Guangdong	CNCAN	23 6.0	N	113 14.0	E	5	23.0	28.0	19.7	16.0	18.2	8.0	3.9	0.1	19.0	21.0	3.5	1.0		
Chiwan (Shenzhen) Guangdong	CNCWN	22 29.0	N	113 54.0	E	5	30.0	33.1	15.5	0.5	27.5	3.0	24.0	20.0	30.0	34.0	2.8	2.0		
Dalian Liaoning	CNDLC	38 55.7	N	121 39.3	E	2	22.2	26.2	2.2	-1.9	24.1	-34.4	-2.0	-15.4	28.9	30.3	3.2	2.6		
Huangpu Guangdong	CNHUA	23 6.0	N	113 26.0	E	5	29.0	34.0	15.8	0.3	27.0	36.0	15.0	5.0	12.0	28.0	2.5	1.8		
Beilun Zhejiang	CNNBO	29 56.0	N	121 53.0	E	5	22.5	26.1	11.0	8.0	29.4	39.5	8.5	-2.6	21.7	10.6	19.6	25.2	3.1	1.1
Ningbo (Beilun) Zhejiang	CNNGB	29 56.0	N	121 53.0	E	5	22.5	26.1	11.0	8.0	29.4	39.5	8.5	-2.6	21.7	10.6	19.6	25.2	3.1	1.1
Shanghai Shanghai	CNSHA	31 14.0	N	121 29.0	E	5	26.4	32.0	6.5	4.0	27.0	40.2	5.0	-10.0	0.8	0.1	4.9	9.0	4.2	1.2
Shanghai Baoshan	CNSHB	31 25.0	N	121 30.0	E	5	25.5	30.0	7.0	5.0	25.7	39.0	8.7	-5.0	0.5	0.1	5.0	5.6	5.5	2.8
Changdao Shandong	CNTAO	36 5.0	N	120 18.0	E	3	24.3	27.0	4.2	2.1	25.2	35.4	-1.1	-15.5	31.8	31.6	32.4	32.6	3.4	1.8
Tianjin Tianjin	CNTSN	39 6.0	N	117 10.0	E	5	26.5	30.5	-0.1	-1.5	28.0	40.0	2.0	-18.3	31.4	28.5	31.9	35.7	3.8	2.0
Yantai Shandong	CNYNT	37 34.0	N	121 26.0	E	3	22.5	26.3	3.0	0.0	24.0	32.0	1.0	-10.0	31.0	29.5	32.0	33.0	2.8	1.8
Cartagena	COCAR	10 21.6	N	75 32.9	W	2	30.5	32.0	31.0	30.0	27.5	28.0	26.0	25.0	28.5	33.0	0.4	0.1		
Kyrenia	CYKYR	35 20.0	S	33 19.0	W	3	25.6	28.5	18.0	16.0	30.5	37.0	10.0	6.0	38.6	39.0	39.2	39.3	0.5	0.1
Larnaca	CYLCA	34 55.0	N	33 39.0	E	3	25.6	28.6	18.2	16.6	31.0	37.0	9.0	5.0	38.6	39.0	39.2	39.4	0.6	0.1
Luxembourg	CYLMS	34 39.0	N	33 1.2	E	3	25.6	28.5	18.2	16.6	32.0	39.0	10.0	6.0	38.6	39.0	39.2	39.4	0.6	0.1
Bremen	DEBRE	53 0.0	N	8 46.8	E	5	14.0	16.5	6.4	3.0	24.0	42.0	1.2	-4.0	18.0	11.0	28.0	30.0	4.2	3.4
Hamburg	DEHAM	53 33.0	N	9 59.0	E	5	16.0	20.0	3.0	0.0	17.3	23.2	0.5	-5.5	4.0	0.0	11.0	18.0	3.0	1.0
Wilhelmshaven	DEWVN	53 32.0	N	8 8.0	E	2	17.0	21.0	4.0	2.0	17.0	24.0	1.2	-4.0	28.0	24.0	32.0	33.0	4.1	2.8
Djibouti (Djibouti)	DJIBJ	11 36.0	N	43 8.0	E	3	29.5	32.0	23.5	20.5	32.2	40.0	26.3	16.0	35.8	36.3	36.9	37.3	1.0	0.5
Enschedevaerts Haven	DKENS	55 1.0	N	9 28.0	E	2	17.0	20.5	3.5	1.5	16.5	24.0	0.0	-8.0	14.0	12.0	18.0	20.0	0.4	0.2
Fredricia	DKFRF	55 34.2	N	9 45.0	E	2	17.5	20.5	3.5	1.5	16.5	24.0	0.0	-8.0	15.0	18.0	21.0	24.0	0.4	0.2
Ain Sukhna	EGAIS	29 34.0	N	32 24.0	E	1	29.0	32.0	20.0	17.0	28.7	42.0	16.7	6.0	41.0	40.0	42.0	43.0	2.3	1.4
Alexandria (El Iskandariya)	EGALY	31 10.8	N	29 52.2	E	3	25.0	29.7	16.0	13.5	29.0	36.0	11.0	7.0	38.0	37.5	38.0	39.0	0.5	0.2
Damietta	EGDAM	31 25.8	N	31 48.0	E	3	25.0	29.7	16.0	13.0	29.0	36.0	11.0	7.0	25.0	20.0	33.0	36.0	0.5	0.2
El Dekhella	EGEDK	31 5.0	N	29 49.0	E	3	25.0	29.7	16.0	13.2	29.0	36.0	11.0	7.0	38.0	37.5	38.0	39.0	0.4	0.2
Port Said	EGPSD	31 15.6	N	32 18.6	E	3	25.0	29.7	16.0	13.2	29.0	36.0	15.0	8.0	37.0	34.0	38.5	39.5	0.6	0.2
Suez (El Suweis)	EGSUJ	29 58.0	N	32 33.0	E	3	29.0	31.4	20.0	17.6	34.0	44.0	18.0	6.0	40.0	39.3	42.0	42.5	1.6	0.9
Gion	ESGJ	43 34.0	N	5 41.0	W	3	18.0	20.0	13.0	11.0	25.0	35.0	7.0	4.0	35.2	34.5	35.4	35.6	4.6	2.2
ESBIO	ESBIO	43 21.6	N	3 4.2	W	5	20.5	22.0	13.0	11.0	25.1	34.5	6.8	4.0	33.0	25.0	35.0	35.5	4.8	2.1
Vigo	ESVGO	42 13.8	N	8 43.8	W	2	18.5	19.5	14.5	12.5	24.0	33.0	8.0	4.0	35.8	35.4	35.8	36.0	4.0	1.8
Barcelona	ESBCN	41 19.8	N	2 9.6	E	3	23.0	24.5	13.0	11.5	27.5	38.4	8.0	6.0	37.0	36.5	37.5	38.0	0.8	0.1
Valencia	ESVIC	39 27.0	N	0 18.0	W	3	25.0	27.0	13.5	12.0	28.0	39.0	10.0	7.5	37.2	37.0	37.6	38.0	0.2	0.0
Algerias	ESALG	36 8.0	N	5 26.0	W	2	22.2	23.4	16.0	14.5	27.0	35.0	12.2	7.0	36.5	36.0	36.5	37.0	0.4	0.1
Las Palmas	ESLPA	28 9.0	N	15 25.0	W	3	22.3	24.0	20.0	17.5	27.2	35.0	14.1	11.0	36.6	36.4	36.6	36.8	2.6	1.0
Tenerife (Santa Cruz de Tenerife)	ESSTC	28 27.0	N	16 14.0	W	3	22.3	24.0	20.0	17.5	27.0	35.0	14.0	11.0	36.6	36.4	36.6	36.8	2.5	0.8
Terragona	ESTAR	41 5.0	N	1 14.0	E	3	25.5	27.0	13.5	11.5	27.5	38.4	8.0	6.0	37.0	36.5	37.5	38.0	0.7	0.1
Dunkerque	FRDKK	51 3.0	N	2 22.0	E	3	17.5	21.0	7.0	3.0	21.0	30.0	3.0	-4.0	32.5	32.0	33.0	33.5	6.1	3.2
Brest	FRBES	48 24.0	N	4 30.0	E	3	17.0	19.5	11.0	9.0	22.0	33.0	4.5	-2.0	34.8	34.4	35.2	35.6	7.5	2.7
Donges	FRDGS	47 16.0	N	2 4.0	E	5	19.5	21.0	11.0	9.0	21.0	29.0	4.0	-1.0	20.0	3.0	32.5	34.0	5.5	2.6
Fos sur Mer (Oil Terminal)	FRFOS	43 24.0	N	4 53.0	E	3	22.0	24.5	14.0	12.5	24.0	31.0	4.5	2.0	33.0	31.0	35.0	36.0	0.1	0.0
Lavera	FRLAV	43 24.0	N	5 0.0	E	5	22.0	24.5	14.0	12.5	24.0	31.0	4.5	2.0	33.0	31.0	35.0	36.0	0.1	0.0
Le Havre	FRLEH	49 29.0	N	0 6.0	E	5	18.0	20.0	9.0	7.0	21.0	29.0	3.0	-2.0	32.5	30.0	34.0	34.5	8.0	3.9
Marseilles	FRMRS	43 19.0	N	5 22.0	E	3	22.0	24.5	14.0	12.5	24.0	31.0	4.5	2.0	33.0	31.0	35.0	36.0	0.1	0.0
Hunterston	GBHST	55 45.0	N	4 53.0	W	2	14.5	16.5	7.0	4.5	18.2	25.0	0.9	-1.0	30.0	27.0	33.0	34.0	3.7	1.9
Inningham	GBIMM	53 38.0	N	0 11.0	W	5	16.0	18.0	6.5	2.3	18.4	26.0	1.1	-1.0	18.0	10.0	24.0	26.0	7.6	3.1
Bury Port (Lilanelly)	GB001	51 40.0	N	4 15.0	W	5	17.0	19.0	8.5	7.0	21.0	27.0	3.0	-1.0	29.0	27.0	32.0	33.5	9.1	3.4
Port Talbot	GBPTB	51 34.0	N	3 48.0	W	3	17.0	19.0	8.5	6.0	18.5	26.0	2.0	-1.0	31.0	30.0	32.0	34.0	8.9	4.0



Port Environmental Data - Input file used for PRIMER Analysis	UN Port Code	Latitude			Longitude			Port Type	Water Temperatures (°C)				Summer Air Temp (°C)		Winter Air Temp (°C)		Salinities (g/L)			Tidal Ranges (m)					
		Deg	Min	S	Lat	Min	W		E	Mean Summer	Maximum Summer	Minimum Summer	Lowest Winter	MSART	USART	Maximum day-time	Lowest night-time	Mean night-time	MWSAL	LWSAL	MDSAL	UWSAL	MSPR	Mean Springs	Mean Neaps
Livorno	ITLIV	43	33.0	N	10	18.6	E	3	24.0	26.0	15.0	13.0	27.5	37.0	5.0	0.5	37.5	37.0	38.0	38.5	0.3	0.0			
Ravenna	ITRAN	44	28.8	N	12	16.8	E	3	25.5	27.0	12.0	10.0	29.0	37.0	4.0	0.5	18.0	10.0	36.0	37.0	0.5	0.2			
Taranto	ITRAR	40	26.0	N	17	12.0	E	3	24.8	27.0	15.0	14.0	29.0	38.0	7.0	24.8	3.0	37.0	38.0	38.5	0.2	0.0			
Venezia (e-Fusina)	ITVAC	45	25.8	N	12	19.8	E	5	25.0	27.0	11.0	9.0	27.0	35.0	4.5	2.0	27.0	14.0	31.0	33.0	0.6	0.1			
Trieste	ITTRS	45	39.0	N	13	45.0	E	3	24.0	26.0	10.0	8.0	27.0	34.0	3.9	0.5	27.0	22.0	35.0	36.0	0.9	0.2			
Abeoshi Hyogo	JPABO	34	45.0	N	134	34.0	E	3	25.5	27.0	11.0	9.0	29.0	36.0	5.0	1.0	25.0	20.0	28.0	30.0	1.6	0.3			
Amagasaki Hyogo	JPAMA	34	41.0	N	135	23.0	E	5	24.0	26.0	11.5	9.0	29.0	34.0	6.0	1.0	18.0	16.0	20.0	25.0	1.5	0.5			
Beppu Oita	JPBEP	33	20.0	N	131	31.0	E	2	24.0	27.5	16.0	12.0	29.0	34.0	3.0	-1.0	19.0	17.0	28.0	31.0	1.5	0.5			
Chiba Chiba	JPCHB	35	35.0	N	140	6.0	E	2	23.0	26.0	12.0	8.0	27.0	35.0	7.0	-4.0	20.0	9.0	28.0	32.0	2.1	0.2			
Kimitsu Chiba	JKPMT	35	23.0	N	139	50.0	E	2	23.0	26.0	12.0	8.0	27.0	35.0	7.0	-4.0	20.0	9.0	28.0	32.0	2.0	0.2			
Fukuyama Hiroshima	JKPKY	34	29.0	N	133	22.0	E	3	23.0	26.0	8.0	4.0	30.0	33.0	2.0	-2.0	17.4	16.3	18.0	22.0	2.9	1.4			
Higashi-Harima Hyogo	JPHHR	34	46.2	N	134	37.8	E	3	25.5	27.0	11.0	9.0	29.0	36.0	5.0	1.0	25.0	20.0	28.0	30.0	1.6	0.3			
Himeji Hyogo	JPHIM	34	43.0	N	134	31.8	E	3	25.5	27.0	10.8	9.5	31.0	31.8	4.0	0.0	18.4	17.0	28.0	30.0	2.4	0.8			
Hakata Fukuoka	JPHKT	33	35.0	N	130	23.0	E	2	23.0	27.0	12.0	8.0	30.0	34.0	3.0	-1.0	23.0	20.0	28.0	32.0	3.3	1.2			
Imabari Ehime	JPIMB	34	4.0	N	133	1.0	E	2	24.0	27.0	10.0	6.0	30.0	34.0	3.0	-1.0	23.0	20.0	28.0	32.0	3.8	1.3			
Inoshima Hiroshima	JPINS	34	16.8	N	133	10.8	E	2	24.0	27.0	10.0	6.0	30.0	34.0	3.0	-1.0	23.0	20.0	28.0	32.0	3.8	1.3			
Iwakuni Yamaguchi	JPWKU	34	10.0	N	132	16.0	E	2	24.0	27.0	15.0	12.0	29.0	34.0	2.0	-1.0	18.0	14.0	21.0	24.0	2.9	1.1			
Kochi Kochi	JKPCZ	33	31.0	N	133	33.0	E	5	24.0	27.0	15.0	12.0	29.0	34.0	2.0	0.0	25.0	16.0	27.0	30.0	2.3	0.7			
Kakogawa Hyogo	JKPGA	34	42.0	N	134	47.0	E	3	25.0	26.5	9.5	8.0	28.0	34.0	3.5	-0.8	24.0	18.0	26.0	29.0	1.3	0.5			
Kure Kagoshima	JKKIU	31	23.0	N	130	32.0	E	2	25.0	28.0	19.0	17.0	30.5	35.0	6.0	3.0	33.0	29.0	33.0	34.5	3.0	0.5			
Nijigata Niigata	JKKIJ	37	54.0	N	139	4.0	E	5	23.0	26.0	10.0	8.0	28.0	33.0	0.5	-6.0	31.0	28.0	32.0	33.0	0.3	0.0			
Kokura Ehime	JKPKK	34	2.0	N	132	50.0	E	2	25.0	27.0	13.0	9.0	30.0	35.0	3.0	-1.0	23.0	20.0	28.0	32.0	3.3	1.1			
Kihara (Ishikawa) Okinawa	JKKIN	26	22.0	N	127	58.0	E	2	26.0	30.0	24.0	20.0	30.0	35.0	15.0	13.0	32.0	27.0	33.0	34.5	2.5	0.5			
Kanda Fukuoka	JKKND	33	48.0	N	131	0.0	E	3	23.5	25.0	8.0	7.0	31.0	30.3	4.0	0.0	16.5	12.5	18.0	20.0	3.6	1.5			
Kinurru Aichi	JKKNU	34	52.0	N	136	57.0	E	5	23.0	26.0	17.0	14.0	27.5	34.0	3.0	1.0	23.5	19.5	29.8	30.5	2.2	0.9			
Kagoshima Kagoshima	JKKKS	31	35.0	N	130	33.0	E	3	24.0	27.0	18.0	16.0	30.5	35.0	4.0	2.0	31.0	26.0	33.0	34.5	2.7	0.4			
Kashima Ibaraki	JKKSM	35	55.0	N	140	42.0	E	3	23.0	25.0	12.5	8.0	28.0	33.0	2.5	-3.0	31.0	29.0	32.0	34.0	1.4	0.1			
Kudamatsu Yamaguchi	JKKLD	34	0.0	N	131	51.0	E	3	23.0	26.0	11.5	10.0	30.0	34.0	7.0	5.0	18.0	14.0	21.0	24.0	3.0	1.0			
Kawasaki Kanagawa	JKKWS	35	32.0	N	139	42.0	E	3	22.5	25.0	12.0	9.0	27.0	34.0	6.0	0.0	20.0	7.0	29.0	31.0	2.5	0.3			
Mazuru Kyoto	JKPMZ	34	28.0	N	135	21.0	E	2	24.5	26.5	13.0	10.0	29.0	34.0	0.3	-4.0	32.0	25.0	34.0	35.0	0.3	0.1			
Mizushima Okayama	JKPMJ	34	30.0	N	133	45.0	E	5	26.1	28.0	11.0	9.0	30.7	34.0	2.0	-3.0	15.0	11.0	15.0	17.0	3.3	1.4			
Moji (Kitaakyushu) Fukuoka	JKPMO	33	57.0	N	130	58.0	E	3	23.5	25.6	7.8	6.9	30.0	34.0	5.8	3.4	16.0	12.0	18.0	20.0	3.0	1.0			
Muroran Hokkaido	JKPMR	42	20.0	N	140	58.0	E	3	15.0	18.0	8.0	2.0	22.0	27.0	3.0	-5.0	28.0	23.0	30.0	32.0	1.5	0.1			
Matsuyama Ehime	JKPMY	33	52.0	N	132	42.0	E	2	25.0	27.0	13.0	9.0	30.0	35.0	3.0	-1.0	23.0	20.0	28.0	32.0	3.4	1.1			
Naha Okinawa	JKPAH	26	12.0	N	127	40.0	E	2	28.0	30.0	24.0	20.0	30.0	35.0	14.0	12.0	32.0	27.0	33.0	34.5	2.6	0.4			
Negishi (Yokohama) Kanagawa	JKPNG	35	24.0	N	139	37.8	E	3	21.9	24.5	12.0	10.0	26.4	35.0	5.1	-1.0	22.0	8.0	31.0	33.5	2.0	0.5			
Nagoya Aichi	JKNGO	35	4.0	N	136	51.0	E	3	22.3	26.0	17.0	13.0	27.1	34.0	6.0	0.0	23.5	19.5	29.8	30.2	1.9	0.6			
Nagasaki Nagasaki	JKNGS	32	45.0	N	129	52.0	E	5	25.0	28.5	16.0	14.0	28.0	34.0	3.5	-0.5	26.0	21.0	33.0	34.5	2.9	1.0			
Oita Oita	JKOIT	33	16.0	N	131	40.0	E	2	24.0	27.5	16.0	12.0	29.0	34.0	3.0	-1.0	19.0	17.0	28.0	31.0	1.6	0.6			
Okinawa Okinawa	JKOKA	26	13.2	N	127	40.2	E	2	28.0	30.0	24.0	20.0	30.0	35.0	14.0	12.0	32.0	27.0	33.0	34.5	2.6	0.4			
Onomichi Hiroshima	JKONO	34	22.0	N	133	11.0	E	3	24.0	27.0	10.0	6.0	30.0	34.0	3.0	-2.0	23.0	20.0	28.0	32.0	3.0	1.3			
Osaka Osaka	JKOSA	34	38.0	N	135	25.0	E	5	24.0	26.0	11.0	8.0	30.0	35.0	6.0	2.0	18.0	14.0	20.0	25.0	1.4	0.2			
Saiki Oita	JKSAE	32	58.8	N	131	55.8	E	2	25.0	28.0	17.0	13.0	29.0	34.0	3.0	-0.5	19.0	17.0	28.0	31.0	2.1	0.7			
Saganoseki Oita	JKSAG	33	14.0	N	131	52.0	E	2	24.0	27.5	16.0	12.0	29.0	34.0	3.0	-1.0	19.0	17.0	28.0	31.0	2.1	0.7			
Sakai Osaka	JKSAK	34	34.0	N	135	27.0	E	5	25.0	28.0	12.0	8.0	30.0	35.0	6.0	2.0	18.0	15.0	21.0	26.0	1.5	0.2			
Shibushi Kagoshima	JKSBS	31	28.0	N	131	7.0	E	3	25.0	28.0	20.0	16.0	30.5	35.0	7.0	4.0	32.0	28.0	33.0	34.5	2.2	0.2			
Sakaide Kagawa	JKSKD	34	21.0	N	133	50.0	E	2	24.0	25.7	11.0	9.5	28.0	33.0	5.0	-2.0	20.0	18.0	26.0	29.0	3.0	1.2			
Sakaminato Totori	JKSMN	35	32.0	N	133	14.0	E	2	25.0	27.0	14.0	12.0	28.7	34.0	1.5	-3.0	32.0	28.0	34.0	35.0	0.9	0.6			
Shimoda Wakayama	JKSMT	34	7.0	N	135	8.0	E	2	23.0	26.0	17.5	14.5	30.0	35.0	2.0	-1.0	23.5	19.5	29.8	30.2	1.9	0.2			
Shimizu Shizuoka	JKSMZ	35	1.0	N	138	30.0	E	2	23.0	26.0	17.0	15.0	28.0	35.0	5.0	2.0	26.0	21.0	31.5	33.0	2.6	0.2			
Tanano (Uno) Okayama	JPTAM	34	28.8	N	133	57.0	E	3	26.1	29.0	11.0	9.0	30.7	36.0	4.0	0.0	20.0	16.0	26.0	29.0	2.4	0.9			
Tobata (Kitakyushu) Fukuoka	JPTBT	33	55.0	N	130																				





Port Environmental Data - Input file used for PRIMER Analysis	UN Port Code	Latitude			Longitude			Port Type	Water Temperatures (°C) [WTT]				Summer Air Temp°C [SART]			Winter Air Temp °C [WART]		Salinities (g/L) [SAL]			Tidal Ranges (m)		
		Deg	Min	S	Lat	Min	W		E	MSUWT	USUWT	MWNT	LWNWT	MSART	Mean day-time	Maximum daytime	MSART	Mean night-time	Lowest night-time	MWSAL	LWSAL	MDSAL	UDSAL
Karachi	PKKHI	24	48.0	N	68	59.0	E	4	27.5	30.0	23.0	21.0	29.0	37.0	10.0	22.3	10.0	35.0	20.0	37.0	40.0	2.8	1.1
Firo	PTFAO	37	0.0	N	7	55.2	W	4	22.0	24.0	24.0	17.5	24.7	37.0	11.0	22.3	11.0	35.0	35.0	35.0	35.0	2.5	0.8
Lisboa	PTLIS	38	42.0	N	9	6.0	W	5	25.0	34.0	15.0	13.0	24.5	36.0	5.0	22.3	5.0	32.0	15.0	35.0	36.0	4.6	2.4
Lagos (Portugal)	PTLOS	37	1.0	N	8	40.0	W	5	21.5	23.0	17.0	14.0	24.8	37.0	9.5	22.3	9.5	32.0	28.0	36.0	36.5	3.5	1.4
Sines	PTSIE	37	58.0	N	8	51.0	W	3	21.0	22.0	16.5	14.5	24.0	36.0	11.0	22.3	11.0	35.5	35.0	36.0	36.5	3.9	1.0
Doha	OADOH	25	18.8	N	51	33.0	E	3	31.0	35.0	17.0	13.0	35.0	44.0	19.0	22.3	12.0	38.5	37.0	40.0	42.0	1.5	0.2
Umm Said (Mesaleed)	OAUUS	24	54.0	N	51	34.0	E	3	31.0	35.0	17.0	13.0	35.0	43.0	20.9	22.3	12.6	39.0	39.0	40.0	41.0	2.4	0.4
Hailu Island	QAHAL	25	39.0	N	52	26.0	E	1	30.0	35.2	22.5	16.9	31.0	42.0	21.0	22.3	11.0	38.0	37.5	39.0	40.5	0.8	0.1
Constanta	ROCHN	44	10.0	N	28	39.0	E	3	23.3	24.0	4.9	0.5	22.2	36.0	2.4	-15.0	15.9	15.0	17.2	17.8	0.1	0.0	
Mangalia	ROMAG	43	49.2	N	28	34.8	E	3	23.5	25.5	5.7	0.5	22.7	36.0	1.4	-15.0	17.0	15.4	17.6	18.0	0.1	0.0	
Midia	ROMID	44	19.8	N	28	40.8	E	3	23.3	24.5	4.5	0.0	22.5	38.0	2.4	-16.0	15.0	12.0	17.0	17.5	0.1	0.0	
Novosyysk Russia	RUNVS	44	43.2	N	37	46.8	E	3	22.1	26.2	7.9	0.5	21.8	41.0	4.3	-24.0	17.6	9.6	17.8	18.8	0.1	0.0	
Tuapse, Russia	RUTUA	44	4.8	N	39	4.2	E	3	23.0	27.1	10.1	5.3	21.5	41.0	6.0	-19.0	16.6	12.7	17.3	18.6	0.1	0.0	
Vladivostok	RUVVO	43	6.6	N	131	53.4	E	2	13.5	15.0	2.5	-1.0	22.0	27.0	-14.5	-25.0	32.0	30.0	33.0	34.0	1.4	0.3	
Dammam	SADMIN	26	30.0	N	50	12.0	E	3	32.0	35.0	17.0	14.0	36.0	48.0	19.0	22.3	10.0	41.0	39.0	43.0	45.0	2.3	0.6
Jeddah	SAJED	21	28.0	N	39	10.0	E	3	30.0	33.0	22.0	19.0	32.0	39.0	21.0	22.3	14.0	38.0	37.0	38.5	39.5	0.2	0.0
Jubail	SAJUB	27	3.0	N	49	40.0	E	3	32.0	36.2	16.0	11.6	36.0	47.0	15.0	22.3	9.0	49.0	48.0	50.0	52.0	1.2	0.7
Al Jubaymah Terminal	SAJUT	26	55.2	N	50	1.0	E	1	31.0	34.0	16.8	13.0	36.0	47.0	15.0	22.3	9.0	40.0	36.0	42.0	44.0	2.4	1.5
Ras Al Khafji	SARAR	28	25.2	N	48	33.0	E	1	32.0	34.9	17.0	15.0	36.8	47.0	14.0	22.3	8.0	39.0	39.0	40.0	40.0	1.6	1.0
Ras Al Ghari	SA001	27	32.0	N	49	33.0	E	1	32.0	34.0	17.0	14.0	36.8	47.0	14.0	22.3	8.0	39.0	38.5	40.0	41.0	1.7	0.9
Ras Al Tamura	SARLT	28	39.0	N	50	10.0	E	1	31.0	33.8	16.8	13.0	36.0	47.0	21.0	22.3	9.0	40.0	38.5	40.5	42.0	2.4	1.5
Yanbu	SAYNB	24	5.0	N	38	3.0	E	3	30.0	33.0	22.0	18.0	32.0	39.0	22.0	22.3	10.0	39.0	37.5	39.5	41.0	0.8	0.3
Marsa Bashaier Oil Terminal	SDBMT	19	24.0	N	37	19.0	E	1	29.5	32.0	23.0	20.0	31.0	40.0	19.0	22.3	12.0	37.5	37.0	37.5	38.0	1.2	0.4
Port Sudan	SDPZU	19	36.0	N	37	13.0	E	3	31.0	34.0	22.0	19.0	32.0	42.0	21.0	22.3	16.0	38.0	37.0	38.5	39.5	1.2	0.4
Singapore Jurong	SGLJR	1	18.0	N	103	43.0	E	3	28.5	31.0	27.0	25.0	31.0	34.0	23.0	22.3	21.0	29.5	28.5	30.5	31.5	2.3	0.9
Singapore Keppel	SGKEP	1	18.2	N	103	52.3	E	3	28.5	31.0	27.0	25.0	31.0	34.0	23.0	22.3	21.0	29.5	28.5	30.5	31.5	2.3	0.9
Singapore Sembawang Port	SGSEM	1	16.0	N	103	20.0	E	4	29.0	31.5	28.0	25.0	31.0	34.0	23.0	22.3	21.0	28.0	27.0	27.0	28.0	2.3	0.9
Singapore Singapore	SGSIN	1	20.0	N	103	20.0	E	3	28.5	31.0	27.0	25.0	31.0	34.0	23.0	22.3	21.0	29.5	28.5	30.5	31.5	2.3	0.9
Singapore Pasir Panjang/Tanjong Pagar	SGTPG	1	15.6	N	103	51.0	E	3	28.5	31.0	27.0	25.0	31.0	34.0	23.0	22.3	21.0	29.5	28.5	30.5	31.5	2.3	0.9
Koper (Slovenia)	SIKOP	45	33.0	N	13	44.0	E	2	24.0	26.5	9.0	7.0	27.0	34.0	3.9	0.5	24.0	18.0	18.0	35.0	36.0	0.8	0.2
Dakar	SNDKR	14	40.2	N	18	38.4	W	3	26.0	27.5	23.0	20.0	33.5	39.0	21.0	16.0	16.0	34.0	34.0	35.0	35.5	2.5	1.2
Bangkok	THBKK	13	42.0	N	100	34.0	E	6	29.0	32.5	27.0	24.0	28.0	38.5	25.0	10.5	10.5	2.0	0.1	12.0	15.0	1.8	0.3
Luem Chabang	THLCC	13	4.0	N	100	50.0	E	3	27.5	30.0	26.0	24.0	28.0	36.0	25.0	14.0	14.0	32.0	30.0	33.0	34.0	1.9	1.3
Dortyd Oil Terminal	TRDYL	36	51.0	N	36	7.8	E	1	26.2	29.2	18.5	15.5	31.2	38.0	6.5	1.0	38.8	37.5	39.1	39.8	0.3	0.0	
Eregli	TRERE	41	18.0	N	31	27.0	E	3	23.5	27.5	6.4	4.0	25.5	36.0	5.7	-5.0	17.5	16.9	17.5	18.2	0.2	0.0	
Istanbul	TRIST	40	59.0	N	29	0.0	E	2	24.4	27.0	6.1	4.0	26.0	37.0	6.6	-11.0	17.5	16.3	17.5	18.3	0.3	0.0	
Izmir (Smyrna)	TRIZM	38	25.2	N	27	4.2	E	2	24.4	25.5	14.0	11.5	32.0	36.0	6.0	0.0	38.0	37.0	38.7	39.2	0.4	0.0	
Izmit (Tutundiklik Oil Terminal)	TRITZ	40	45.0	N	29	55.0	E	2	24.0	27.0	7.0	5.0	26.0	36.0	8.0	-7.0	17.5	16.3	17.5	18.3	0.3	0.1	
Mersin	TRMER	36	46.0	N	34	39.0	E	3	26.2	28.8	19.0	16.0	30.0	35.0	6.5	1.0	38.8	37.5	39.1	39.8	0.3	0.1	
Samsun	TRSSX	41	21.0	N	36	34.2	E	3	24.6	28.0	7.6	6.0	25.0	36.0	7.9	-8.0	17.5	16.9	17.5	18.2	0.1	0.0	
Yanmca	TRYAR	40	46.2	N	29	42.0	E	1	24.0	27.0	7.0	5.0	25.0	36.0	6.0	-7.0	17.5	16.3	17.5	18.3	0.3	0.0	
Keelung (Chilung)	TWKEL	25	9.0	N	121	44.0	E	3	22.5	25.0	20.0	18.0	26.0	30.0	20.0	16.0	34.0	31.0	34.0	34.5	2.5	0.5	
Kuohsiung	TWKHH	22	37.0	N	120	15.0	E	3	28.0	31.3	23.0	21.0	27.3	30.8	21.5	18.0	34.0	34.0	35.0	35.5	1.0	0.3	
Taiichung	TWTKG	23	17.0	N	120	30.0	E	3	27.0	30.0	18.0	16.0	26.6	30.1	18.6	15.6	26.0	17.0	33.0	34.5	4.8	3.9	
Dar Es Salaam	TZDAR	7	10.0	S	39	17.0	E	2	29.0	32.0	26.0	24.0	31.0	37.0	22.0	17.0	30.0	20.0	34.0	35.5	3.8	1.5	
Dnepro-Bugsky (Ochakov)	UADNB	46	45.0	N	31	55.0	E	5	21.4	26.0	1.3	-0.6	20.3	40.0	-0.6	-29.0	5.2	0.5	3.0	12.5	0.7	0.0	
Ilyichevsk	UAILK	46	20.0	N	30	39.0	E	3	18.9	23.6	2.6	-0.7	22.6	38.0	0.5	-22.0	13.8	8.8	14.5	18.2	0.1	0.0	
Codessa	UAODS	46	30.0	N	30	52.8	E	3	18.4	24.5	2.6	-3.1	20.2	37.0	0.3	-27.0	13.5	5.4	16.1	20.0	0.1	0.0	
Nicodavev	UANIK	46	58.0	N	30	39.0	E	6	21.4	26.0	1.3	-0.6	20.4	39.0	-0.7	-30.0	0.1	0.1	0.2	0.5	0.0	0.0	
Sevastopol	UASVP	44	37.2	N	33	31.8	E	2	14.5	25.9	7.8	1.7	20.5	36.0	4.3	-22.0	18.0	15.2	18.0	19.8	0.2	0.1	
Boston Massachusetts	USBOS	42	21.0	N	71	4.8	W	2	21.0	17.0	0.5	-2.0	26.2	33.0	-5.0	-14.0	26.0	18.0	29.0	31.0	3.3	1.4	
New York New York (New Jersey)	USNYC	40	42.0	N	74	1.0	W	5	14.0	20.0	2.0	-1.0	27.5	37.0	-3.0	-16.0	8.0	0.0	22.0	30.0	1.6	1.3	
Philadelphia Pennsylvania (Port Richmond)	USPHL	39	57.0	N	75	10.0	W	5	18.0	22.0	2.0	-1.0	28.0	36.0	-3.0	-12.0	0.0	0.0	1.0	3.0	1.9	1.6	
Wilmington Delaware	USILG	39	45.0	N	75	30.0	W	5	18.0	22.0	2.0	-1.0	28.0	36.0	-3.0	-12.0	0.0	0.0	3.0	6.0	1.8	1.6	

Port Environmental Data - input file used for PRIMER Analysis	UN Port Code	Latitude		Longitude		Port Type	Water Temperatures (°C)				Summer Air Temp°C [SART]		Winter Air Temp °C [WART]		Salinities (g/L) [SAL]			Tidal Ranges (m)				
		Deg	Min	S	N		Deg	Min	W	E	MSUWT	USUWT	MWUWT	LWUWT	MSART	USART	MWART	LWART	MWSAL	LWSAL	MDSAL	UDSAL
Baltimore Maryland	USBAL	39	16.8	N	76	34.8	W	5	23.0	24.0	2.5	0.0	30.5	36.0	-1.0	-10.0	0.0	0.0	4.0	8.0	0.4	0.3
Hampton Roads	USHPF	36	58.0	N	76	20.0	W	5	23.0	27.0	12.0	7.0	29.1	36.0	0.5	-5.0	21.0	15.0	26.0	31.0	1.1	0.7
Norfolk- Newport News Virginia	USNEN	36	51.0	N	76	19.0	W	5	23.0	27.0	11.0	8.0	29.1	36.0	0.5	-5.0	21.0	15.0	26.0	31.0	1.2	0.8
Savannah Georgia	USSAV	32	5.0	N	81	5.0	W	5	27.0	30.0	19.0	16.0	31.8	37.0	4.8	-2.0	18.0	10.0	28.0	33.0	3.0	2.2
Mobile Alabama	USMOB	30	40.0	N	88	1.8	W	5	27.0	31.0	16.0	9.0	32.5	38.0	5.6	2.0	8.0	0.0	30.0	35.0	1.0	0.3
Lake Charles Louisiana	USLCH	30	13.2	N	93	13.2	W	5	27.0	29.0	20.0	15.0	32.0	39.0	6.0	1.0	0.0	0.0	7.0	13.0	0.5	0.0
Davout	USDVT	29	36.0	N	89	51.0	W	6	27.0	31.0	12.0	10.0	32.5	38.0	5.6	2.0	0.0	0.0	0.0	0.0	0.2	0.0
New Orleans	USMSY	29	57.0	N	90	4.0	W	6	27.0	31.0	17.5	15.0	32.0	39.0	7.0	4.0	0.0	0.0	0.0	0.0	0.0	0.0
LOOP Terminal	USLOP	28	52.8	N	90	1.2	W	1	27.0	29.0	20.0	17.0	29.0	38.0	14.0	5.5	30.0	24.0	31.0	34.0	0.4	0.2
Sabine	USSAB	29	42.0	N	93	52.0	W	2	27.0	29.0	19.5	16.5	31.0	38.0	8.0	3.0	35.5	35.0	36.0	36.5	0.5	0.3
Beaumont	USBPT	30	5.0	N	94	5.0	W	6	28.5	32.0	16.0	13.0	33.0	41.0	5.8	1.5	0.0	0.0	5.0	10.0	0.5	0.1
Galveston Texas	USGLS	29	17.0	N	94	50.0	W	2	28.5	33.0	18.0	16.0	32.0	40.5	9.5	2.0	18.0	14.0	26.0	33.0	0.5	0.1
Texas City Texas	USTXT	29	23.0	N	94	54.0	W	2	28.5	34.0	18.0	16.0	32.0	40.5	9.5	2.0	18.0	14.0	26.0	33.0	0.4	0.1
Houston Texas	USHOU	29	45.0	N	95	19.8	W	5	28.5	32.0	16.0	14.0	33.0	41.0	5.8	1.5	2.0	0.0	10.0	18.0	0.4	0.1
Anchorage Alaska	USANC	61	13.8	N	149	52.8	W	5	8.0	12.0	1.0	-1.0	17.0	24.0	-12.0	-19.0	2.0	0.0	8.0	12.0	8.8	5.0
Portland Oregon	USPDY	45	35.0	N	122	44.0	W	6	12.0	14.0	1.0	-2.0	25.5	32.0	1.5	-3.0	0.0	0.0	0.0	0.0	0.0	0.0
Vancouver Washington	USBCC	45	36.0	N	122	40.0	W	6	12.0	14.5	1.0	-2.0	25.4	32.0	1.1	-3.0	0.0	0.0	0.0	0.0	0.0	0.0
San Francisco California	USFFO	37	48.0	N	122	25.2	W	5	15.0	20.0	12.0	11.0	22.5	31.0	6.0	2.0	28.0	10.0	30.0	32.0	2.0	0.6
Oakland California	USOAK	37	48.8	N	122	18.0	W	5	15.0	20.0	12.0	11.0	22.5	31.0	6.0	2.0	15.0	5.0	27.0	30.0	2.0	0.7
Long Beach California	USLGB	33	45.0	N	118	12.0	W	3	18.0	22.0	14.0	12.0	27.0	34.0	7.6	1.0	33.0	31.0	33.2	33.8	2.0	0.6
San Diego	USSAN	32	42.0	N	117	10.2	W	2	18.0	22.0	15.0	13.0	25.1	34.0	9.8	3.0	34.0	33.5	35.0	37.0	2.2	1.4
Montevideo	UYMVD	34	54.0	S	56	13.2	W	3	25.0	26.8	15.0	12.5	26.0	34.0	5.0	0.0	5.0	1.0	10.0	30.0	0.3	0.1
Aden (Yemen)	YEADE	12	48.0	N	44	54.0	E	2	29.0	31.0	23.0	21.0	33.0	39.0	26.3	16.0	36.0	35.5	36.1	36.5	1.5	0.5
Hodeidah (Yemen)	YEHOD	14	48.0	N	42	55.0	E	2	29.5	32.0	23.5	20.5	32.0	39.0	26.3	16.0	36.0	35.2	36.5	37.5	1.2	0.2
Al Mukallah (Yemen)	YEMKX	14	31.0	N	49	9.0	E	3	29.5	32.0	23.5	20.5	32.0	39.0	26.3	16.0	36.0	37.5	36.1	36.5	1.2	0.4
Ras Isa Marine Terminal (Yemen)	YERAI	15	7.8	N	42	36.0	E	1	29.5	32.0	23.5	20.5	32.0	39.0	26.3	16.0	36.0	35.5	36.5	37.0	1.1	0.3
Cape Town	ZACPT	33	54.0	S	18	26.0	E	3	14.0	16.0	13.5	11.5	18.2	26.0	11.0	9.0	20.0	10.0	34.3	34.8	1.5	0.6
Durban	ZADUR	29	53.0	S	31	2.0	E	5	24.5	25.5	21.0	19.0	26.3	26.1	15.4	14.5	25.0	16.0	35.5	35.5	1.8	0.6
Port Elizabeth	ZAPLZ	33	58.0	S	25	38.0	E	3	20.5	25.5	16.5	12.5	23.6	25.0	10.0	8.5	35.2	34.9	34.9	35.0	1.6	0.5
Richards Bay	ZARCB	28	48.0	S	32	3.0	E	4	25.5	26.5	22.0	20.0	28.0	29.5	15.5	12.0	39.2	37.0	38.2	41.4	1.9	0.5
Saldanha Bay	ZASDB	33	2.0	S	18	0.0	E	2	18.5	22.6	14.0	9.0	26.0	35.0	10.0	4.0	34.9	34.6	34.9	35.0	1.4	0.6

Port Environmental Data - input file used for PRIMER Analysis	Total Rainfall (mm) [RF] for the...				Distance to River Mouth (km)	Size of River Catchment (km <sup>2</sup> )	Intertidal Habitats [I]										Shallow Subtidal Habitats [S]				
	DBMRP	W6MRP	W6MRP	RNFU75			DISRVM	SIZRVC	Smooth artificial wall/jetty	Rocky artificial wall/jetty	Wood artificial post/piles	High tide salt marsh	Sand beach	Stony Beach	Low tide mud flat	Mangrove	Natural rocky shore	Firm sands	Soft mud	Seagrass meadow	Rocky reef /seafloor
Name of Port	DBMRP	W6MRP	W6MRP	RNFU75	DISRVM	SIZRVC	INASMW	INARKW	INAWP	INHFTSM	INSHDB	INSTNB	INLTMF	INMANG	INRKSH	SUFSND	SUSFTM	SUSGRM	SURKRF	SUCORF	
Abu Dhabi	3	92	4	4	8	30	5	5	4	3	4	2	4	4	4	5	2	4	4	4	4
Mina Zayed	3	92	4	4	8	30	5	5	4	3	4	2	4	4	4	5	2	4	4	4	4
Das Island	5	76	4	4	110	120	5	4	0	0	4	0	1	1	4	5	3	4	4	4	4
Port Rashid	2	100	4	4	5	25	5	4	3	4	1	2	4	4	2	5	2	2	5	4	4
Dubai	2	100	4	4	5	25	5	4	3	4	1	2	4	4	2	5	2	2	5	4	4
Falsh Oil Terminal	5	75	4	4	165	20	5	0	0	0	2	0	0	0	2	3	5	1	2	1	1
Fujairah	4	60	4	4	65	540	5	5	3	0	4	4	0	0	4	5	4	4	3	1	1
Jebel Ali	2	90	5	5	70	2,100	5	5	5	2	4	3	2	2	4	5	2	4	3	2	2
Jebel Dhanna	5	75	4	4	20	120	5	4	1	4	4	0	4	4	4	4	5	4	2	2	2
Rhor Al Fakkan	4	60	4	4	42	540	5	4	4	2	0	3	0	0	4	5	2	4	3	1	1
Umm Al Qwain	2	90	5	5	22	1,000	5	4	4	4	5	4	4	4	4	5	2	4	3	3	3
Ruwais Oil Terminal	5	75	4	4	20	120	5	4	1	4	4	0	4	4	4	5	4	4	2	2	2
Sharjah	2	98	5	5	20	100	5	4	3	4	2	3	4	4	3	5	0	2	5	3	3
Zirku Island	5	75	4	4	85	120	5	4	0	1	4	0	1	1	4	4	3	4	4	4	4
Buenos Aires	424	581	9	9	-155	600,000	5	4	4	0	4	2	4	0	1	4	5	3	1	0	0
Campana	424	581	9	9	-250	280,000	5	4	5	0	1	4	1	0	0	5	5	0	0	0	0
Dampier	41	231	5	5	180	105,000	5	5	3	2	4	0	4	3	5	4	5	4	5	2	2
Port Walcott (Cape Lambert)	41	231	5	5	225	105,000	5	4	3	2	3	0	3	3	5	5	3	4	4	4	2
Port Bonython	161	355	7	7	65	550	5	4	3	2	5	0	2	3	4	5	3	4	4	0	0
Whyalla	119	151	9	9	40	990	5	4	4	4	2	5	0	2	4	5	3	4	3	0	0
Port Pirie	125	219	8	8	30	990	5	2	3	3	5	0	2	3	4	5	3	4	3	0	0
Port Stanvac	290	440	6	6	30	1,500	5	5	0	1	4	0	3	0	4	5	3	4	3	0	0
Western Port (near Hastings; AUHAS)	245	302	9	9	25	900	5	1	4	3	4	1	4	0	4	5	5	3	4	0	0
Port Kemba	457	913	8	8	12	400	5	5	4	1	3	0	2	1	4	5	5	4	5	0	0
Ensbane	389	779	7	7	-2	6,600	5	5	4	4	4	3	4	4	3	5	5	4	3	4	4
Bundaberg	323	620	7	7	-5	3,300	5	3	4	2	3	1	1	1	3	5	2	3	5	3	5
Gladstone	244	704	7	7	4	9,000	5	5	3	4	4	0	5	4	5	5	5	4	5	4	4
Port Alma	245	558	7	7	-16	143,000	5	2	4	4	2	4	1	1	4	2	5	4	5	4	4
Hay Point	297	1312	6	6	6	500	5	4	3	2	2	2	2	2	2	5	4	2	2	4	4
Dallymple Bay (= Hay Point Anchorage)	297	1312	6	6	6	500	5	4	3	2	2	2	2	2	2	5	4	2	2	4	4
Mackay	297	1312	6	6	5	2,500	5	4	5	2	2	2	2	3	2	5	5	2	2	2	2
Abbot Point	158	853	6	6	18	2,768	5	4	2	2	2	2	3	3	2	5	4	1	2	4	4
Townsville	119	990	6	6	-1	200	5	4	5	3	2	2	2	2	2	5	4	1	2	2	2
Lucinda	204	742	6	6	6	8,614	5	3	3	3	2	3	2	3	3	5	3	2	3	4	4
Mourilyan	909	2643	7	7	-1	1,600	5	2	4	3	1	1	1	1	1	2	5	1	1	1	3
Calms	279	1726	6	6	7	300	5	2	5	4	3	1	1	1	1	2	5	1	4	4	4
Cape Flattery	224	1586	6	6	14	114	5	4	0	1	1	3	3	3	1	4	1	3	1	4	4
Weipa	58	1687	5	5	-5	4,107	5	3	4	4	1	2	2	2	2	2	5	2	2	3	3
Karumba	36	884	5	5	-3	121,290	5	0	5	4	2	5	1	1	5	4	5	2	2	5	5
Chittagong	149	1484	4	4	-3	1,200,000	5	2	5	0	0	0	5	3	0	2	5	3	3	1	0
Zuierpen	334	460	8	8	-75	4,300	5	5	5	0	1	1	2	0	0	2	5	0	0	0	0
Ghent (Gent)	334	460	8	8	-51	2,150	5	5	5	0	2	2	3	0	0	2	5	1	0	0	0
Bourgas	285	294	9	9	320	817,000	5	5	4	4	4	3	3	0	4	4	5	0	4	0	0
Varna, Bulgaria	246	282	8	8	250	817,000	5	5	4	3	3	2	2	0	2	4	5	0	4	0	0
Sitra (Bahrain)	2	72	4	4	90	50	5	4	3	3	4	3	3	3	3	5	3	4	3	4	4
Mina Sulman (Al Manamah)	2	72	4	4	90	50	5	5	3	3	4	3	3	3	4	5	3	4	3	4	4
Ibajai	584	961	8	8	-3	15,500	5	4	5	4	4	0	5	5	4	4	2	0	4	0	0
Paranaguá	648	1288	8	8	-15	797	5	5	3	0	4	0	5	5	4	4	4	0	5	0	0
Santos	738	1343	7	7	-3	154	5	5	3	0	4	0	5	5	4	5	0	3	0	3	0
Sepelba	750	750	7	7	5	2,500	5	3	3	1	4	0	4	4	4	3	5	0	4	4	0
Rio de Janeiro	750	750	7	7	1	30	5	4	4	4	0	4	0	4	3	3	5	0	4	5	0
Ponta do Ubu	446	829	7	7	65	1,400	5	5	0	2	5	0	1	1	1	5	2	0	1	0	0
Victoria	446	829	7	7	-6	1,400	5	5	2	1	4	0	5	4	4	3	5	0	5	0	0
Praia Mole	446	829	7	7	4	1,400	5	5	2	1	4	0	4	3	5	4	5	0	4	4	0
Tubarao	446	829	7	7	4	1,400	5	5	2	0	4	0	4	3	5	4	5	0	4	4	0

Port Environmental Data - input file used for PHIMER Analysis	Total Rainfall (mm) [RF] for the...		Distance to River Mouth (km)	Size of River Catchment (km <sup>2</sup> )	Intertidal Habitats [I]					Shallow Subtidal Habitats [S]									
	Direst 6 months	Wettest 6 months			No. of months for 75%	INASMW	INARKW	INAWP	INHTSM	INSNDB	INSTNB	INLTMF	INMANG	INRKSH	SUFSND	SUSFTM	SUSGRM	SURKRF	SUCORF
Name of Port	D6MRF	W6MRF	RNFL75	DIRVM	SIZRVC	INASMW	INARKW	INAWP	INHTSM	INSNDB	INSTNB	INLTMF	INMANG	INRKSH	SUFSND	SUSFTM	SUSGRM	SURKRF	SUCORF
Salvador	727	1384	8	4	35,000	5	5	2	0	4	0	2	2	5	4	5	0	4	0
Come By Chance	530	860	8	5	200	5	0	0	0	0	4	0	0	5	3	3	0	5	0
Sept-les (Pointe Noire) Quebec	510	596	9	6	6,000	5	4	3	0	3	4	1	0	5	3	0	0	5	0
Halifax Nova Scotia	603	793	8	1	400	5	4	0	0	0	4	0	0	5	3	5	0	5	0
La Have	603	793	8	-3	2,000	5	1	4	0	0	5	0	0	5	3	3	0	5	0
Vancouver (British Columbia)	300	807	6	0	85,000	5	4	4	0	2	4	3	0	4	4	5	0	5	0
Roberts Bank (British Columbia)	300	807	6	0	85,000	5	3	3	0	3	4	3	0	4	4	5	0	5	0
Guangzhou Guangdong	341	1362	6	-112	400,000	5	4	4	4	1	0	5	1	2	2	5	1	1	0
Chiwai (Shenzhen) Guangdong	320	1604	6	4	1,000,000	5	3	5	0	3	2	1	3	3	2	5	2	3	2
Dalian Liaoning	183	457	7	35	1,500	5	5	5	2	3	4	4	0	5	4	5	2	4	0
Huangpu Guangdong	326	1606	6	-95	452,600	4	3	5	4	4	2	5	1	2	3	5	1	2	1
Beilun Zhejiang	464	947	8	-3	600	5	2	5	3	4	2	5	0	4	4	5	2	4	0
Ningbo (Beilun) Zhejiang	464	947	8	-3	600	5	2	5	3	4	2	5	0	4	4	5	2	4	0
Shanghai Shanghai	480	840	8	-40	1,500,000	5	3	5	2	1	0	5	0	1	3	5	1	1	0
Shanghai Baoshan	392	742	7	-45	1,500,000	5	4	4	2	1	0	5	0	1	3	5	1	1	0
Qingdao Shandong	192	577	6	24	8,800	5	5	4	2	1	3	0	0	4	3	5	3	4	0
Tianjin Tianjin	278	603	8	0	71,600	5	5	5	2	3	1	3	0	2	4	5	2	1	0
Yantai Shandong	190	500	7	30	1,200	5	5	4	0	3	4	4	0	2	4	5	2	4	0
Carfagna	80	863	3	15	1,400	5	4	2	3	4	0	4	4	3	3	5	4	3	3
Kyrenia	139	958	5	120	40	5	5	5	0	3	4	1	0	4	4	2	4	5	0
Larnaca	139	958	5	25	50	5	5	5	0	4	4	1	0	4	4	2	4	5	0
Limassol	41	411	4	3	60	5	5	5	0	4	4	1	0	4	4	2	4	5	0
Bremen	322	428	8	-15	6,500	5	2	5	0	1	2	5	0	2	2	5	1	2	0
Hamburg	429	325	9	-105	9,000	5	4	5	0	1	2	5	0	1	2	5	0	1	0
Wilhelmshaven	322	428	8	1	750	5	5	4	2	3	2	5	0	1	4	5	2	1	0
Djibouti (Djibouti)	14	33	6	5	900	5	5	4	2	4	3	2	2	4	5	3	3	0	4
Enschede/kerks Haven	293	411	9	2	200	5	2	3	1	2	4	2	0	5	2	5	1	5	0
Fredericia	217	337	9	8	300	5	4	4	1	2	4	2	0	4	2	5	1	5	0
Ain Sukhna	3	29	4	3	200	5	3	0	2	4	0	2	2	4	5	4	2	0	4
Alexandria (El Iskandariya)	10	186	4	45	2,000	5	4	0	2	4	3	0	0	3	5	5	3	3	0
Damietta	7	100	4	7	3,000	5	5	0	2	4	4	2	0	0	5	0	4	0	0
El Dekhela	10	186	4	52	2,000	5	4	0	2	4	3	0	0	3	5	5	3	3	0
Port Said	6	190	4	270	2,000,000	5	5	4	4	3	1	4	0	2	4	5	3	3	0
Suez (El Suweis)	5	100	4	63	200	5	5	4	2	4	0	3	3	4	5	3	1	2	1
Sijon	425	670	9	6	40	5	5	5	1	4	3	3	0	4	5	5	2	4	0
Bilbao	436	655	9	-2	4,500	5	4	4	2	3	3	5	0	3	5	5	2	2	0
Vigo	503	1303	6	14	400	5	4	3	2	3	4	2	0	5	5	5	2	5	0
Barcelona	349	241	9	11	5,000	5	5	5	0	3	2	2	0	3	5	5	3	3	0
Valencia	150	318	6	4	550	5	5	4	2	5	3	0	0	1	4	5	4	2	0
Ageiras	690	146	5	35	1,600	5	5	5	0	5	5	0	0	4	3	5	3	5	0
Las Palmas	17	159	4	1	60	5	5	3	0	4	3	0	0	4	5	5	3	5	0
Tenerife (Santa Cruz de Tenerife)	46	396	9	2	20	5	5	3	0	2	3	0	0	4	5	5	3	5	0
Tarazona	349	241	9	75	6,000	5	5	4	1	3	3	4	0	3	5	5	3	3	0
Dunkerque	284	347	9	27	1,800	5	5	3	2	4	4	4	0	0	5	5	0	0	0
Brest	404	724	8	20	600	5	4	4	2	3	4	3	0	4	5	5	3	5	0
Donges	336	475	8	-3	1,300	5	4	4	0	4	4	0	0	3	4	5	3	3	0
Fos sur Mer (Oil Terminal)	195	387	7	0	3,000	5	4	3	2	3	3	0	0	3	4	5	3	3	0
Lavera	195	387	7	0	3,000	5	4	4	2	3	3	0	0	3	4	5	3	3	0
Le Havre	405	723	7	0	6,500	5	4	4	0	4	4	4	0	4	4	5	3	3	0
Marseilles	195	387	7	0	3,000	5	4	5	2	3	3	0	0	3	4	5	3	3	0
Hunterston	443	662	8	30	2,400	5	4	3	1	5	3	4	0	4	5	5	0	4	0
Immingham	271	330	9	-20	4,900	5	5	4	2	3	3	5	0	4	5	5	0	0	0
Burry Port (Llanelli)	309	507	9	0	180	5	5	5	4	4	5	4	0	3	4	5	0	3	0
Port Talbot	385	534	9	2	280	5	5	5	2	4	4	4	0	2	4	5	0	2	0

Port Environmental Data - input file used for PRIMER Analysis	Total Rainfall (mm) (RF) for the...			Distance to River Mouth (km)	Size of River Catchment (km <sup>2</sup> )	Intertidal Habitats [I]										Shallow Subtidal Habitats [S]				
	D6MRF	W6MRF	RNF175			DIRVM	SZRVC	INASMW	INARKW	INAMP	INHMS	INSDB	INSTNB	INLTMF	INMANG	INRKSH	SUFSND	SUSFTM	SUSGRM	SURKRF
Redcar	285	330	9	-4	3,000	5	5	4	3	3	4	4	0	3	4	5	0	3	0	
Batum, Georgia	539	978	7	7	22,000	5	5	4	4	4	3	4	0	4	4	5	0	4	0	
Poli, Georgia	537	840	8	4	13,300	5	5	4	3	4	1	3	0	2	4	5	0	1	0	
Sibiralt	680	146	6	25	1,600	5	5	3	0	4	4	0	0	4	3	5	3	5	0	
Aspropyros	180	278	6	4	5,600	5	5	4	0	5	4	2	0	4	5	4	2	3	0	
Elefis (Eleusis)	69	302	6	5	961	5	5	4	0	4	4	2	0	4	4	5	2	4	0	
Chios	181	278	6	6	93	5	5	5	0	4	5	1	0	5	4	3	2	5	0	
Pachi	69	302	6	34	855	5	4	1	0	2	2	2	0	5	4	4	2	5	0	
Piraeus	69	302	6	14	320	5	5	4	0	4	3	3	0	4	5	3	3	4	0	
Thessaloniki	181	278	7	6	1,800	5	5	5	0	4	4	2	0	3	4	5	3	4	0	
Volos	181	278	6	0	164	5	5	4	0	4	4	2	0	4	4	5	3	4	0	
Hong Kong	206	2520	5	33	1,000,000	5	5	3	1	3	3	3	3	3	3	4	3	4	3	
Hong Kong Kowloon	206	2520	5	33	1,000,000	5	5	3	1	3	3	3	3	3	3	4	3	4	3	
Omsalj	470	570	9	18	250	5	0	2	0	1	2	0	0	5	3	2	1	5	0	
Belawan Sumatra	960	1150	9	12	550	5	0	4	0	3	0	5	5	3	4	5	3	3	2	
Dumai Sumatra	965	1267	9	42	20,000	5	2	4	0	3	0	5	4	2	3	5	4	1	1	
Cijading	266	869	7	5	70	5	3	5	1	1	1	1	1	4	4	4	3	2	2	
Merak (inc. Anyet Terminal) Java	480	1335	7	20	700	5	4	4	0	3	1	2	2	4	5	3	3	5	4	
Jakarta Java	288	1434	6	5	300	5	4	5	0	4	3	1	3	3	5	4	3	3	3	
Cilacap Java	1325	2172	8	-1	900	3	2	3	1	3	1	2	1	2	3	4	3	3	3	
Semarang Java	312	1390	6	2	200	5	4	1	3	5	1	2	5	5	5	2	5	4	4	
Tanjung Perak (Surabaya) Java	203	1277	6	1	200	5	3	4	0	1	2	1	2	2	4	4	2	2	2	
Tanjung Bara Coal Terminal Kalimantan	1272	1494	9	80	100,000	5	0	0	0	3	0	2	3	4	5	4	4	4	4	
Balkpapan Kalimantan	1272	1494	9	100	100,000	5	4	5	0	3	0	4	4	4	5	4	3	3	3	
Amamape Irian Jaya	1203	1330	9	0	500	5	4	5	1	5	1	1	1	5	5	3	3	4	4	
Manapaent	544	878	8	-18	4,000	5	2	5	2	3	4	4	0	5	4	5	0	5	0	
Ashdod	7	100	4	3	20	5	5	0	0	4	4	0	0	0	5	0	4	0	0	
Mumbai (Ex Bombay)	287	2246	2	10	9,800	5	1	2	0	2	0	5	4	4	4	4	0	4	0	
Calcutta	149	1484	4	-140	1,200,000	5	2	5	1	0	0	5	1	0	5	0	0	0	0	
Cochin	498	2417	3	-3	6,170	5	5	5	0	5	0	5	5	1	2	2	0	1	0	
Halida	149	1484	4	-36	1,200,000	5	4	5	2	3	0	5	3	1	3	5	1	0	0	
Mangalore (New Mangalore)	268	2739	2	15	2,500	5	4	4	0	5	3	3	3	3	4	4	0	2	0	
Kandla	3	338	2	-40	150,000	5	1	4	3	2	0	5	5	2	2	5	0	2	3	
Chennai (Ex Madras)	341	863	7	110	50,000	5	5	4	3	0	5	0	1	1	4	5	1	1	0	
Marmugao (Marmagao)	49	2915	4	0	2,500	5	5	4	3	4	3	4	3	5	4	5	0	4	0	
Mundra	6	485	2	10	1,100	5	5	5	4	4	0	5	4	1	0	5	2	1	1	
Portbandar	350	1500	3	18	1,200	5	5	4	3	3	3	2	2	4	3	5	2	4	0	
Paradeep	198	1551	4	5	132,100	5	5	2	0	5	0	4	4	1	4	4	0	2	0	
Salya	150	900	3	2	800	5	4	4	3	3	2	5	4	3	3	5	2	4	0	
Sikka	6	485	2	14	1,100	5	4	3	2	0	0	4	4	1	0	5	2	1	5	
Tulicorrin (New Tulicorrin)	158	506	3	15	14,400	5	5	3	0	5	0	4	4	5	4	4	2	5	3	
Vadinar Terminal	150	900	3	2	800	4	4	3	3	3	2	3	3	3	4	5	2	4	0	
Vishakapatnam	78	799	4	15	113,000	5	5	2	0	4	0	1	1	4	3	5	0	4	4	
Bandar Imam Khomeyni	2	190	3	144	500,000	5	0	5	2	0	2	5	0	0	5	1	0	0	0	
Bandar Mushar (Mushahr)	2	190	3	100	500,000	5	0	5	2	0	2	5	0	0	5	1	0	0	0	
Bandar Abbas (Oil Jetty)	11	172	4	30	42,000	5	5	0	3	3	1	5	2	1	5	5	2	2	2	
Bushahr	5	160	4	25	12,000	5	0	3	3	4	2	5	1	0	4	5	3	0	2	
Kharik Island	2	154	4	31	12,000	5	5	4	2	4	4	2	2	4	5	3	4	0	5	
Lavan Island	0	84	3	140	42,000	5	0	0	0	4	4	0	0	4	5	4	4	0	4	
Sinn Island Oil Terminal	0	84	3	140	42,000	5	0	0	0	4	4	0	0	4	5	4	4	0	4	
Hisharforfur	220	330	8	4	200	5	5	4	0	0	4	0	0	4	5	4	0	5	0	
Straumsvik	220	330	8	1	200	5	5	4	0	0	4	0	0	4	5	4	0	5	0	
Genoa	451	825	6	28	600	5	4	4	0	0	4	0	0	4	3	3	0	5	0	
Porto Foli (Sarroch)	294	641	7	20	400	5	3	0	2	4	3	1	0	4	3	2	3	4	0	

Port Environmental Data - input file used for PRIMER Analysis	Total Rainfall (mm) [RF] for the...				Distance to River Mouth (km)	Size of River Catchment (km <sup>2</sup> )	Intertidal Habitats [I]							Shallow Subtidal Habitats [S]						
	Driest 6 months		Wettest 6 months				Smooth artificial wall/fieety	Rocky artificial wall/fieety	Wood post/piles	High tide salt marsh	Sand beach	Stony beach	Low tide mud flat	Mangrove	Natural rocky shore	Firm sands	Soft mud	Seagrass meadow	Rock reef /seafloor	Coral reef
	DBMRF	W6MRF	RN1/5	RN1/5																
Name of Port	DBMRF	W6MRF	RN1/5	RN1/5	DISRVM	SIZEVC	INAMSW	INARKW	INAWP	INHISM	INSNDB	INSTNB	INTLME	INMANG	INRKSH	SUFSND	SUSFTM	SUSGRM	SURKRF	SUCORF
Livorno	343	565	8	8	20	4,100	5	5	5	2	4	4	0	0	3	3	5	3	4	0
Ravenna	346	411	9	9	0	2,000	5	5	4	0	3	3	4	0	3	3	5	2	4	0
Taranto	132	308	7	7	8	550	5	4	3	2	3	2	2	0	4	3	5	3	4	0
Venezia (Fusina)	438	604	8	-2	-2	1,200	5	5	4	2	3	1	3	0	3	3	5	3	2	0
Trieste	469	573	9	9	20	3,000	5	4	4	0	3	3	3	0	3	3	5	2	3	0
Abooshi Hyogo	400	800	7	7	3	460	5	5	3	2	2	4	2	0	4	4	4	3	4	0
Amagasaki Hyogo	431	885	7	0	0	2,600	5	4	2	0	3	4	2	0	3	3	2	3	4	0
Beppu Oita	465	1176	6	10	10	1,500	4	3	2	1	3	4	2	0	4	3	4	2	5	0
Chiba Chiba	580	1100	7	16	16	860	5	4	4	1	2	3	3	0	3	3	5	2	3	1
Kimitsu Chiba	580	1100	7	11	11	860	5	4	4	1	2	3	3	0	3	3	5	2	3	1
Fukuyama Hiroshima	342	834	7	5	5	649	5	3	2	1	3	2	2	0	2	3	3	2	5	0
Higashi-Harima Hyogo	390	950	6	10	10	1,656	5	4	3	2	3	4	3	0	4	3	4	3	4	0
Hiraji Hyogo	400	800	7	10	10	480	5	5	4	2	2	3	2	0	3	3	5	3	4	0
Hakata Fukuoka	509	1095	7	6	6	280	5	3	2	1	2	3	2	0	3	3	2	2	5	0
Imabari Ehime	450	899	4	2	2	70	5	3	4	2	3	3	4	0	3	3	5	3	4	0
Inoshima Hiroshima	340	850	6	15	15	340	5	3	4	2	3	3	4	0	3	3	5	3	4	0
Iwakuni Yamaguchi	489	1045	7	3	3	260	5	4	4	4	3	3	4	0	3	4	5	3	4	0
Kochi Kochi	798	1841	4	-4	-4	640	5	3	4	3	3	3	4	0	3	4	5	3	4	0
Kakogawa Hyogo	402	916	7	1	1	1,656	5	4	2	2	2	3	2	0	3	3	4	3	4	0
Kure Kagoshima	632	1607	6	20	20	100	4	4	2	2	3	4	2	3	4	4	3	2	5	2
Niigata Niigata	724	1065	6	-2	-2	1,800	5	4	4	0	3	2	3	0	5	3	5	2	4	0
Kikuna Ehime	450	899	4	1	1	10	5	3	4	2	3	3	4	0	3	3	5	3	4	0
Kinwau (Ishikawa) Okinawa	818	1320	7	5	5	10	5	4	2	2	4	4	3	4	4	4	5	4	0	4
Kanda Fukuoka	554	1106	7	4	4	40	5	4	3	2	3	4	3	0	4	3	2	2	5	0
Kinura Aichi	478	1057	7	-2	-2	350	5	4	4	2	3	2	3	0	3	3	5	3	2	0
Kagoshima Kagoshima	632	1607	6	2	2	260	5	4	2	2	3	4	2	2	2	3	3	2	5	3
Kashima Ibaraki	683	983	8	32	32	1,600	5	4	2	1	4	3	1	0	2	5	4	2	3	0
Kudamatsu Yamaguchi	635	1210	7	1	1	30	5	4	3	1	3	1	3	0	5	3	5	3	5	0
Kawasaki Kanagawa	570	1100	7	4	4	2,200	5	4	4	1	2	3	3	0	3	3	5	2	3	1
Mizuru Kyoto	781	1020	8	12	12	1,600	5	4	4	0	2	4	3	0	5	2	5	2	3	1
Mizushima Okayama	339	821	7	2	2	1,990	5	4	2	1	3	2	3	0	3	4	5	4	4	0
Moji (Kitakyushu) Fukuoka	554	1106	7	13	13	300	5	3	1	1	2	2	2	0	2	3	3	3	5	0
Muroran Hokkaido	724	1065	6	15	15	740	5	4	4	2	4	4	3	0	5	3	5	2	4	0
Matsuyama Ehime	450	899	4	12	12	270	5	3	4	2	3	3	4	0	3	3	5	3	4	0
Naha Okinawa	818	1320	7	2	2	15	5	4	4	4	2	3	3	0	3	4	5	4	0	4
Negishi (Tokonama) Kanagawa	548	1021	7	3	3	230	5	4	4	1	4	3	3	0	3	3	5	3	4	1
Nagoya Aichi	478	1057	7	2	2	900	5	4	4	2	4	1	3	0	3	3	5	4	5	0
Nagasaki Nagasaki	562	1417	6	-5	-5	480	5	3	5	0	3	4	3	0	4	3	5	3	5	1
Oita Oita	465	1176	6	3	3	2,150	4	3	2	1	3	4	2	0	4	3	4	2	5	0
Okinawa Okinawa	818	1320	7	2	2	15	5	4	4	3	4	2	3	3	3	4	5	4	0	4
Onomichi Hiroshima	340	850	6	2	2	60	5	3	5	2	3	3	4	0	3	4	5	3	4	0
Osaka Osaka	430	880	7	0	0	16,000	5	4	3	0	3	4	2	0	3	3	5	2	3	0
Saiki Oita	465	1176	6	18	18	2,150	4	3	2	1	3	4	2	0	4	3	4	2	5	0
Saganoseki Oita	465	1176	6	18	18	2,150	4	3	2	1	3	4	2	0	4	3	3	3	4	0
Sakai Osaka	430	880	7	1	1	1,600	5	4	4	0	3	4	2	0	4	4	4	3	4	0
Shibushi Kagoshima	632	1607	6	2	2	140	5	4	4	2	3	4	2	3	4	4	3	2	5	2
Sakaide Kagawa	358	775	7	4	4	120	4	4	3	0	2	2	2	0	2	4	4	2	5	0
Sakaminato Totori	848	1075	9	11	11	280	5	4	4	3	4	3	3	0	4	4	4	2	3	0
Shimoda Wakayama	456	886	7	3	3	25	5	4	4	2	4	1	3	0	3	3	5	4	4	1
Shimizu Shizuoka	738	1356	7	1	1	900	5	4	4	1	3	4	3	0	4	4	5	3	4	0
Tanano (Uto) Okayama	339	821	7	23	23	1,990	5	4	2	1	3	2	3	0	3	4	5	4	5	0
Tobata (Kitakyushu) Fukuoka	554	1106	7	5	5	10	5	3	4	1	3	2	4	0	2	4	4	4	5	0
Tokuyama Yamaguchi	631	1213	7	1	1	70	5	4	3	1	3	1	4	0	3	3	5	3	5	0
Tomakomai Hokkaido	724	1065	6	0	0	10	5	4	4	0	3	3	3	0	5	3	5	2	4	0
Toyama Toyama	327	739	7	3	3	4,800	5	4	4	0	3	2	3	0	3	3	5	2	3	0

Port Environmental Data - input file used for PRIMER Analysis	Total Rainfall (mm) (RF) for the...		Distance to River Mouth (km)	Size of River Catchment (km <sup>2</sup> )	Intertidal Habitats [I]										Shallow Subtidal Habitats [S]						
	Direct 6 months	Wettest 6 months			DBMRF	WBMRF	RNF/75	DiSRM	SiZRVC	Smooth artificial wall/jetty	Rocky artificial wall/jetty	Wood piling	High tide salt marsh	INSDB	INSTNB	Low tide mud flat	INMANG	INRKSH	Natural rocky shore	Firm sands	Soft mud
Name of Port	DBMRF	WBMRF	RNF/75	DiSRM	SiZRVC	INASMW	INARKW	INAWP	INHTSM	INSDB	INSTNB	INLTMF	INMANG	INRKSH	SUFSND	SUSFTM	SUSGRM	SURKRF	SUCORF		
Tokyo Tokyo	585	1110	7	0	3,200	5	4	3	1	2	3	3	0	2	2	5	2	3	1		
Ube Yamaguchi	631	1213	7	2	85	5	4	3	0	3	2	3	0	2	4	3	4	5	0		
Kobe Hyogo	295	1021	6	2	510	5	3	4	0	3	4	4	0	4	3	5	4	0			
Wakayama Wakayama	420	850	7	2	3100	5	4	4	2	4	1	3	0	4	3	5	4	0			
Yokohama Mie	505	1082	7	13	900	5	4	4	2	3	1	3	0	3	3	5	4	0			
Yokohama Kanagawa	548	1021	7	3	230	5	4	4	1	4	3	3	0	3	3	5	3	1			
Yokosuka Kanagawa	550	1000	7	20	230	5	4	4	1	4	3	2	0	4	4	5	4	1			
Mombasa	355	789	8	100	9,000	5	4	5	4	4	2	4	4	4	5	5	3	3			
Kwangyang	344	958	7	7	2,100	5	3	4	1	3	3	2	0	4	4	4	3	0			
Pohang	294	774	7	0	2,300	5	4	2	2	3	2	3	0	2	3	5	3	1			
Kunsan	344	931	4	0	500	5	4	3	1	2	3	2	0	4	3	5	3	0			
Mogoo (Mogoo)	344	931	4	7	1,000	5	4	3	2	2	2	2	0	5	3	5	2	4			
Chuan	358	1175	6	3	900	5	4	3	2	2	2	2	0	1	3	3	4	0			
Pusan	308	1032	7	15	1,690,000	5	4	2	0	3	2	4	0	2	3	2	3	2			
Samcheon Po	361	933	7	16	400	5	3	2	1	2	1	2	0	1	4	4	3	2			
Ulsan	344	942	7	3	900	5	4	2	0	3	1	2	0	1	3	4	4	0			
Yosu (Yosu)	344	958	7	26	2,100	5	3	3	1	3	3	2	0	4	3	3	4	0			
Kuwait (Shuwaikh, KWSMK)	8	91	5	140	500,000	5	5	5	0	3	4	3	2	3	5	5	4	3			
Mina Al Ahmedi	5	90	4	105	500,000	5	5	1	2	2	1	2	2	3	5	2	3	2			
Mina Saud	15	95	4	160	500,000	5	4	1	2	4	2	3	2	4	5	2	2	2			
Mina Abulla	7	91	5	120	500,000	5	2	1	2	2	2	1	2	2	4	5	3	3			
Shuaba	5	90	4	115	500,000	5	5	1	2	3	2	2	2	3	5	2	3	2			
Colombo	644	1597	7	22	880	5	5	4	1	4	3	2	2	3	4	5	3	1			
Malta (Valletta)	117	493	7	200	120	5	5	0	0	3	4	0	0	4	5	4	5	0			
Penang (Georgetown)	770	1351	8	0	460	5	4	4	0	4	3	1	1	3	5	4	4	4			
Lumut	780	1450	8	-2	400	5	3	5	0	3	2	5	3	4	4	5	3	3			
Port Kelang	885	1305	8	-1	650	5	3	3	0	2	4	1	1	4	5	4	3	5			
Port Dickson	713	1600	7	6	400	5	2	3	0	4	2	3	3	4	4	5	4	4			
Kapar Coal Terminal	885	1305	8	1	140	5	2	3	0	2	3	1	1	3	5	3	3	5			
Pasir Gudang Johor	1101	1433	8	10	2,800	5	2	4	3	4	3	1	2	3	4	4	4	4			
Binulu Sarawak	1632	1993	9	9	3,700	5	4	4	0	2	1	3	3	1	5	3	2	2			
Laos	405	1336	6	0	18,000	5	4	5	0	3	0	5	4	2	3	5	3	0			
Tin Can Island	405	1336	6	16	18,000	5	4	4	0	4	0	5	4	2	3	5	3	2			
Port Harcourt	551	1798	6	-66	120,000	5	0	5	0	1	2	5	4	2	4	5	0	1			
Omne	560	1600	6	-40	120,000	5	4	4	0	2	3	5	4	2	4	5	0	1			
Bonny	605	1444	6	0	8,000	5	0	5	0	2	0	5	4	0	2	5	3	0			
Europoort	362	469	8	0	2,500	5	5	3	0	3	3	4	0	1	2	5	1	0			
Rotterdam	362	469	8	-10	2,500	5	5	4	0	2	2	4	0	0	2	5	1	0			
Ijmuiden	475	365	9	-1	300	5	5	4	1	4	3	4	0	1	4	5	2	0			
Amsterdam	472	360	9	-18	5,000	5	5	5	0	2	2	5	0	0	4	5	1	0			
Flushing (Vlissingen)	460	370	9	-3	600	5	5	4	2	4	3	4	0	1	4	5	1	0			
Auckland	487	687	8	3	200	5	4	3	2	2	2	2	0	3	3	5	2	0			
Whangarei	487	673	9	0	600	5	0	4	1	5	3	5	0	5	4	5	2	4			
Marsden Point	487	673	9	20	600	5	0	2	1	4	3	2	0	5	3	2	5	0			
Callao (Lima)	6	14	6	10	400	5	5	4	2	4	3	2	0	3	5	5	3	4			
Lae	1760	2689	8	2	7,980	5	4	4	2	2	1	2	2	1	5	2	3	1			
Port Moresby	236	919	6	7	85	5	5	5	2	1	2	2	2	1	5	3	1	1			
Daru	250	960	6	35	55,000	5	0	5	3	4	0	4	4	4	5	5	4	3			
Batangas (Luzon)	365	1372	6	2	500	5	3	4	4	2	4	1	1	4	5	4	3	4			
Bataan Mariveles	216	1607	6	25	900	5	3	4	4	2	4	1	1	4	5	4	3	4			
Lima	216	1607	6	4	900	5	4	2	3	3	2	3	3	3	5	4	4	3			
Manila	216	1607	6	6	1,200	5	4	4	1	2	2	1	3	2	5	3	4	4			
Subic Bay (Sana Clara)	228	1797	6	4	1,800	5	5	3	1	3	3	3	4	3	5	3	4	3			
Muhammad Bin Qasim	50	165	3	-30	240,000	5	4	4	3	2	0	5	4	2	2	5	1	0			

Port Environmental Data - input file used for PHIMER Analysis	Total Rainfall (mm) [RF] for the...			Distance to River Mouth (km)	Size of River Catchment (km <sup>2</sup> )	Intertidal Habitats [I]										Shallow Subtidal Habitats [S]						
	Direst 6 months	Wettest 6 months	No of months for 75%			INASMW	INARKW	INAWP	Wood post/piles	High tide salt marsh	INHTSM	INSNDB	INSTNB	Low tide mud flat	INLTMF	INMANG	Natural rocky shore	INRKSH	Firm sands	SUSFTM	SUSGRM	Seagrass meadow
Name of Port	D6MRF	W6MRF	RNLF75	DIRVM	SIZRVC	INASMW	INARKW	INAWP	INHTSM	INSNDB	INSTNB	INLTMF	INMANG	INRKSH	SUSFTM	SUSGRM	SURKRF	SUCORF				
Karachi	47	156	3	4	240,000	5	4	5	4	4	0	5	4	3	2	5	2	2	0			
Faro	87	434	5	80	8,250	5	4	4	3	3	2	4	0	4	3	4	3	3	0			
Lisboa	164	538	6	0	11,000	5	4	5	3	2	3	5	0	4	3	5	2	3	0			
Lagos (Portugal)	87	434	5	0	40	5	4	5	2	4	4	4	0	4	5	5	3	4	0			
Sines	164	538	4	30	700	5	4	4	2	3	3	2	0	4	4	1	0	4	0			
Doha	5	76	4	5	300	5	5	4	4	3	4	3	4	4	5	4	2	3	4			
Umm Said (Mesaieed)	5	76	4	10	400	5	4	3	4	4	2	3	4	4	5	3	4	0	4			
Halul Island	5	76	4	95	300	5	4	0	1	4	0	1	1	4	5	3	4	4	4			
Constantia	196	224	9	115	817,000	5	5	4	3	4	4	3	0	2	4	5	0	1	0			
Mangalia	191	222	9	145	817,000	5	5	4	3	4	4	3	0	2	4	5	0	1	0			
Mida	196	224	9	95	817,000	5	5	4	2	4	4	4	0	2	4	5	0	1	0			
Novorossiysk, Russia	320	488	9	270	1,410	5	5	4	2	3	3	2	0	5	4	5	1	4	0			
Tuapse, Russia	609	930	7	140	1,410	5	5	4	1	3	2	1	0	4	4	4	1	4	0			
Vladivostok	90	637	5	25	15,000	5	4	5	0	3	3	4	0	5	5	5	0	5	0			
Darmann	15	60	4	3	80	5	5	4	2	4	1	4	4	3	4	5	4	3	3			
Jeddah	5	60	3	20	800	5	5	4	3	4	0	3	3	4	4	4	3	3	4			
Jubail	15	100	4	170	1,000	5	5	4	3	4	4	3	3	4	5	3	4	0	3			
AJ Juaymah Terminal	15	100	4	200	1,000	3	3	1	2	3	0	2	2	3	4	5	2	2	2			
Ras Al Khafji	15	95	4	170	500,000	5	2	1	2	2	1	2	2	2	4	5	3	3	2			
Ras Al Ghar	15	95	4	170	1,000	5	5	1	2	4	3	2	2	4	5	3	4	4	1			
Ras Al Tannura	15	100	4	170	1,000	5	4	2	3	4	2	3	2	4	5	3	4	4	1			
Yambu	2	55	3	2	400	5	4	0	3	4	0	3	3	3	5	3	3	3	4			
Masa Bashayer Oil Terminal	10	40	4	30	1,000	5	3	3	2	3	0	2	2	2	4	5	3	3	4			
Port Sudan	10	40	4	2	1,000	5	5	4	3	3	0	4	3	4	4	5	3	3	2			
Singapore Jurong	927	1103	9	5	200	5	4	4	3	2	2	4	4	2	3	5	2	2	2			
Singapore Keppel	927	1103	9	5	200	5	4	4	3	2	2	4	4	2	3	5	2	2	2			
Singapore Sembawang Port	927	1103	9	2	2,800	5	4	4	3	4	1	1	1	4	3	5	3	4	4			
Singapore Singapore	927	1103	9	5	200	5	4	4	3	2	2	4	4	2	3	5	2	2	2			
Singapore Pasir Panjang/Tanjong Pagar	927	1103	9	5	200	5	3	5	3	1	3	3	3	1	3	5	2	2	2			
Koper (Slovenia)	470	570	9	0	400	5	4	4	0	3	3	3	0	3	3	5	2	3	0			
Dakar	9	494	3	170	40,000	5	5	4	2	4	0	2	2	4	5	5	3	3	2			
Bangkok	190	1307	6	-25	250,000	5	2	5	0	5	5	1	4	5	1	5	4	1	1			
Laem Chabang	327	1000	6	8	330	5	3	4	0	2	1	2	4	4	2	5	3	3	4			
Dortmud Oil Terminal	102	652	5	5	400	5	2	2	2	3	4	1	0	4	4	2	3	5	0			
Erepli	194	551	6	70	65,000	5	5	4	0	4	4	3	0	4	3	5	0	4	0			
Istanbul	190	523	7	400	817,000	5	5	4	1	2	4	2	0	5	3	5	1	5	0			
Izmir (Smyrna)	95	602	5	145	5,000	5	4	4	2	3	4	1	0	4	4	3	2	5	0			
Izmir (Tuncelilik Oil Terminal)	190	523	6	450	817,000	5	3	5	1	3	4	1	0	5	4	2	0	4	0			
Mersin	102	652	5	1	450	5	5	3	2	4	4	1	0	4	4	2	3	5	0			
Samsun	296	482	8	60	78,200	5	5	4	0	3	3	1	0	4	3	5	0	3	0			
Yarimca	190	520	7	440	817,000	5	4	3	1	3	4	1	0	5	3	3	1	5	0			
Keelung (Chitung)	1721	2009	9	8	45	5	5	3	0	3	4	2	5	5	2	4	3	2	4			
Kaohsiung	159	1593	5	10	100	5	5	3	1	3	4	1	4	3	4	3	3	4	4			
Taichung	370	935	7	10	1,600	5	5	4	0	4	1	1	4	1	2	4	4	3	5			
Dar ES Salaam	248	810	6	95	100,000	5	5	5	3	3	0	5	4	2	5	5	3	3	4			
Dnepro-Bugsky (Obchakov)	227	237	9	0	505,810	5	2	5	0	2	2	3	0	1	2	5	0	1	0			
Ilychevsk	155	179	9	80	573,810	5	4	4	4	5	3	3	0	2	4	5	2	3	0			
Odessa	148	242	8	54	573,810	5	5	3	2	5	4	2	0	3	2	5	4	3	0			
Nicolayev	156	191	9	-80	68,000	5	1	5	2	2	2	1	0	2	2	5	0	2	0			
Sevastopol	162	238	9	300	817,000	5	4	4	1	2	2	1	0	5	4	3	2	4	0			
Boston Massachusetts	486	684	9	0	2,000	5	4	5	0	3	4	3	0	4	3	5	0	5	0			
New York New York (New Jersey)	556	633	9	-5	25,000	5	5	4	0	2	4	2	0	4	4	5	0	4	0			
Philadelphia Pennsylvania (Port Richmond)	485	559	9	-50	8,400	5	5	5	0	0	4	3	0	4	3	8	0	3	0			
Wilmington Delaware	485	559	9	-30	8,400	5	5	5	0	1	4	3	0	4	3	5	0	1	0			



Port Environmental Data - input file used for PRIMER Analysis	Total Rainfall (mm) [RF] for the...			Distance to River Mouth (km)	Size of River Catchment (km <sup>2</sup> )	Intertidal Habitats [I]						Shallow Subtidal Habitats [S]								
	Driest 6 months	Wettest 6 months	No. of months for 75%			INASMW	INARKW	INAWP	INHTSM	INSDIB	INSTNB	INLTMF	INMANG	INRKSH	SUFSND	SUSFTM	SUSGRM	SURKRF	SUCORF	
Name of Port	D6MRF	W6MRF	RNFL75	DISRVM	SIZRVC	INASMW	INARKW	INAWP	INHTSM	INSDIB	INSTNB	INLTMF	INMANG	INRKSH	SUFSND	SUSFTM	SUSGRM	SURKRF	SUCORF	
Baltimore Maryland	518	574	9	-70	25,000	5	5	5	0	0	4	4	0	4	3	5	5	0	4	0
Hampton Roads	498	635	8	-10	25,000	5	5	3	2	3	2	4	0	4	5	5	0	4	0	0
Norfolk-Newport News Virginia	498	635	8	-10	25,000	5	4	3	2	3	2	4	0	4	5	5	0	4	0	0
Savannah Georgia	433	705	9	0	45,000	5	4	3	2	3	0	4	0	0	5	5	3	3	1	0
Mobile Alabama	758	915	9	-2	151,000	5	4	4	3	3	1	4	2	0	3	5	2	0	0	0
Lake Charles Louisiana	630	786	7	-26	7,500	5	4	4	3	3	1	4	2	0	4	5	2	0	0	0
Davant	758	915	9	-60	1,000,000	5	5	3	1	4	4	4	1	1	4	5	1	1	0	0
New Orleans	718	946	8	-140	1,000,000	5	3	5	0	0	4	5	0	1	0	5	0	1	0	0
LOOP Terminal	729	944	8	60	1,000,000	5	2	1	1	1	0	4	1	0	2	5	2	0	1	1
Sabine	723	941	8	5	600	5	4	3	3	4	3	4	2	3	4	5	3	0	0	0
Beaumont	540	691	8	-70	12,500	5	5	5	2	3	3	5	2	0	4	5	1	0	0	0
Galveston Texas	459	609	9	0	8,000	5	5	3	3	4	2	5	4	2	4	5	4	1	0	0
Texas City Texas	459	609	9	-12	8,000	5	5	3	3	3	2	5	4	2	3	5	3	1	0	0
Houston Texas	540	681	8	-35	8,000	5	4	5	2	3	1	5	2	1	2	5	2	1	0	0
Anchorage Alaska	117	280	7	0	15,000	5	5	0	2	4	3	0	0	4	3	5	0	5	0	0
Portland Oregon	231	689	6	-195	200,000	5	4	5	0	3	5	1	0	5	5	5	0	5	0	0
Vancouver Washington	230	764	6	-188	200,000	5	4	5	0	3	5	1	0	5	5	5	0	5	0	0
San Francisco California	44	453	5	15	30,000	5	4	3	2	3	3	3	0	4	4	5	0	4	0	0
Oakland California	44	453	5	14	30,000	5	4	4	2	3	3	3	0	4	4	5	0	4	0	0
Long Beach California	11	165	2	5	2,500	5	5	3	2	3	3	3	0	2	5	5	0	3	0	0
San Diego	22	233	5	14	550	5	4	4	2	4	4	3	4	2	5	5	0	0	0	0
Montevideo	540	591	9	0	600,000	5	4	5	3	4	3	4	0	4	5	5	0	3	0	0
Aden Yemen	14	33	6	6	15,500	5	5	4	3	4	3	3	3	4	4	5	4	3	4	4
Hodeidah Yemen	14	33	6	14	8,200	5	5	4	2	4	2	2	2	3	5	5	4	3	3	3
Al Mukallah Yemen	14	33	6	70	12,000	5	5	4	0	5	3	0	0	5	5	4	1	5	1	1
Ras Isa Marine Terminal Yemen	14	33	6	55	8,200	5	2	2	1	3	2	1	0	4	5	4	4	3	3	3
Cape Town	197	630	6	3	217	5	4	4	2	4	4	2	0	4	4	5	2	4	4	0
Durban	332	758	7	3	180	5	4	4	3	4	0	3	4	4	5	4	3	2	0	0
Port Elizabeth	363	783	8	1	84	5	5	5	2	4	0	2	0	4	5	5	2	3	0	0
Richards Bay	462	757	8	2	183	5	4	4	4	4	0	5	4	2	5	5	4	3	0	0
Saldanha Bay	69	274	5	70	7,900	5	5	4	2	4	0	3	0	4	5	4	3	4	0	0

# **APPENDIX 7**

## **Consultants' Terms of Reference**





## Consultants' Terms of Reference

---

### **Activity 3.1: Ballast Water Risk Assessments**

#### **6 Demonstration Sites**

---

#### **1. Introduction & Background**

The International Maritime Organization (IMO), with funding provided by the Global Environment Facility (GEF) through the United Nations Development Programme (UNDP), has initiated the Global Ballast Water Management Programme (GloBallast).

This programme is aimed at reducing the transfer of harmful marine species in ships' ballast water, by assisting developing countries to implement existing IMO voluntary guidelines on ballast water management (IMO Assembly Resolution A.868(20)), and to prepare for the anticipated introduction of an international legal instrument regulating ballast water management currently being developed by IMO member countries.

The programme aims to achieve this by providing technical assistance, capacity building and institutional strengthening to remove barriers to effective ballast water management arrangements in six initial demonstration sites. These six sites are Sepetiba, Brazil; Dalian, China; Mumbai, India; Kharg Island, Iran; Saldanha, South Africa and Odessa, Ukraine. The initial demonstration sites are intended to be representative of the six main developing regions of the world, as defined by GEF. These are respectively, South America, East Asia, South Asia, Middle East, Africa and Eastern Europe. As the programme proceeds it is intended to replicate these initial demonstration sites throughout each region.

#### **2. The Need for the Risk Assessments**

The development objectives of the programme are to assist countries to implement the existing IMO voluntary ballast water management guidelines and to prepare for the introduction of a new international legal instrument on ballast water.

The current IMO ballast water management guidelines offer states significant flexibility in determining the nature and extent of their national ballast water management regimes. This flexibility is warranted given that nations are still experimenting with approaches. A port state may wish to apply its regime uniformly to all vessels which visit, or it may wish to attempt to assess the relative risk of vessels to valuable resources and apply the regime selectively to those which are deemed of highest risk.

The uniform application option offers the advantages of simplified programme administration in that there are no "judgement calls" to be made or justified by the port state regarding which vessels must

participate and which need not. In addition, the system requires substantially less information management demands. Finally, it offers more protection from unanticipated invaders, and overall protection is not dependent upon the quality of a decision support system which may not be complete. The primary disadvantages of this approach are: 1) additional overall cost to vessels which otherwise might not need to take action, and 2) more vessels will be involved in undertaking the measures, and therefore the port state will need to monitor compliance from a greater number of vessels.

Some nations are experimenting with systems to allow more selective applicability based upon voyage-specific risk assessments because this approach offers to reduce the numbers of vessels subject to ballast water controls and monitoring. The prospect of reducing the numbers of ships to which the program applies is especially attractive to nations that wish to eliminate introductions of target organisms such as toxic dinoflagellates. More rigorous measures can be justified on ships deemed to be of 'high risk' if fewer restrictions are placed on low risk vessels. However, this approach places commensurate information technology and management burdens on port state and its effectiveness depends on the quality of the information supporting it. The approach may also leave the country/port vulnerable to unknown risks from non-target organisms.

For countries/ports which choose the selective approach, it will be essential to establish an organized means of evaluating the potential risk posed by each vessel entering their port, through a Decision Support System (DSS). Only in this way can they take the most appropriate decision regarding any required action concerning that vessels' ballast water discharge. The DSS is a management system that provides a mechanism for assessing all available information relating to individual vessels and their individual management of ballast water so that, based upon assessed risk, the appropriate course of action can be taken.

Before a pilot country decides on whether to adopt the 'blanket' (i.e. all vessels) approach or to target specific, identified high risk vessels only, a general, first-past risk assessment needs to be carried out. This should look at shipping arrival patterns and identify the source ports from which ballast water is imported. Once these are identified, source port/discharge port environmental comparisons should be carried out to give a preliminary indication of overall risk. This will greatly assist the port state to assess which approach to take.

The GloBallast programme, under Activity 3.1; will support these initial , 'first-past' risk assessments as a consultancy on contract to the PCU. This is important for establishing the level and types of risks of introductions that each port faces, as well as the most sensitive resources and values that might be threatened. These will differ from site to site, and will determine the types of management responses that are required.

The PCU risk assessment consultants, in conducting the risk assessment in each pilot country, will work with and train country counterpart(s) and include them in the study process as part of the capacity building objectives of the programme, so as to allow each country to undertake its own risk assessments in future.

### **3. Scope of the Risk Assessments**

A Risk Assessment will be undertaken for each of the ports of:

- Sepetiba, Brazil;
- Dalian, China;
- Mumbai, India;
- Kharg Island, Iran;
- Saldanha, South Africa and
- Odessa, Ukraine.

The Risk Assessments will apply to all ship movements into and out of these ports based on shipping data for the last 10 years (or longer if available).

#### **4. Services Required & Tasks to be Undertaken**

The GloBallast PCU requires a suitably qualified and experienced consultancy team to undertake the ballast water risk assessments. The consultancy team will undertake the following Tasks, for each demonstration site:

##### Task 1: Resource Mapping

Identify, describe and map on Geographic Information System (GIS) all coastal and marine resources (biological, social/cultural and commercial) in and around the demonstration site that might be impacted by introduced marine species.

##### Task 2: De-ballasting/Ballasting Patterns

Characterise, describe and map (on GIS) de-ballasting and ballasting patterns in and around the ports including locations, times, frequencies and volumes of ballast water discharges and uptakes.

##### Task 3: Identify Source Ports

Identify all ports/locations from which ballast water is imported (source ports).

##### Task 4: Identify Destination Ports

Identify all ports/locations to which ballast water is exported (destination ports).

##### Task 5: Database - IMO Ballast Water Reporting Form

Establish a database at the nominated in-country agency for the efficient ongoing collection, management and analysis of the data collected at the demonstration site according to the standard IMO Ballast Water Reporting Form, and the data referred to under Tasks 2, 3 and 4.

##### Task 6: Environmental Parameters

Characterise as far as possible from existing data, the physical, chemical and biological environments for both the demonstration site and each of its source and destination ports.

##### Task 7: Environmental Similarity Analysis

Using the data from Task 6 and an appropriate multivariate environmental similarity analysis programme, develop environmental similarity matrices and indices to compare each demonstration site with each of its source ports and destination ports, as the basis for the risk assessment.

##### Task 8: High Risk Species

Identify as far as possible from existing data, any high risk species present at the source ports that might pose a threat of introduction to the demonstration site, and any high risk species present at the demonstration site that might be exported to a destination port.

### Task 9: Risk Assessment

For each demonstration site, assess and describe as far as possible, the risk profile for invasive marine species being both introduced from its set of source ports and exported to its set of destination ports, and identify the highest risk source and destination ports, using the outputs of Tasks 1 to 8 and based on the environmental similarity indices developed under Task 7.

### Task 10: Training & Capacity Building

While undertaking the risk assessment, provide training and capacity building to the in-country risk assessment team (up to 10 people) in the risk assessment methodology, including use of database established under Task 5 and the multivariate environmental similarity analysis programme established under Task 7.

### Task 11: Information Gaps

Identify any information gaps that limit the ability to undertake these Tasks and recommend management actions to address these gaps.

## **5. Methods to be Used**

The consultants should clearly outline in their Tender how each Task will be achieved. These should comply with but are not necessarily restricted to the following:

### Site Visits:

The consultants will undertake an initial one week (5 working days) visit to each demonstration site to hold discussions with the CFP, CFP-A, port authority, maritime administration, environment administration, fisheries/marine resources administration, marine science community and shipping industry, to identify and obtain information and data for the various Tasks, establish a working relationship with the in-country risk assessment team, conduct a site familiarisation to the demonstration site (port) and to identify information gaps.

The consultants will undertake second 8 to 10 working day visit to each demonstration to install the GIS, database and multivariate environmental similarity analysis programme and to provide training and capacity building in their use and the overall risk assessment methodology to the in-country risk assessment team.

### Coordination:

The consultants will maintain close consultation and cooperation with the PCU Technical Adviser (TA), who will manage this consultancy, and with the Country Focal Point (CFP) and CFP Assistant (CFP-A) in each pilot country, who provide the primary contact point for all in-country activities and for accessing in-country information and data.

### Tasks 1& 2:

This will be restricted existing data only, field surveys are not provided for in the budget. The CFP and/or CFP-A will compile as much existing information as possible in relation to Tasks 1 and 2 to provide to the consultants.

The consultants should identify and evaluate any existing in-country databases and GIS for use in these Tasks. The GIS should be tailored to suit the country's circumstances while ensuring user-friendliness and consistency across all sites.

Tasks 3 & 4:

This will be restricted to existing data only. The CFP and/or CFP-A will compile as much existing information as possible in relation to Tasks 3 and 4 to provide to the consultants. However, the consultants should identify potential additional sources of data for these two tasks, including records held by port authorities, shipping agents, customs agencies and similar, that may not have been identified/compiled by the CFP/CFP-A.

Task 5:

The consultants should identify and evaluate any existing in-country databases for use in this Task. The database should be tailored to suit the country's circumstances while ensuring user-friendliness, consistency with the IMO Ballast Water Record Form and consistency across all sites.

Task 6:

This will be based on existing data only. The consultants should clearly outline in their Tender what parameters will be used, and how the data for these parameters will be collected from the source and destination ports.

Task 7:

The consultants should clearly outline in their Tender what multivariate environmental similarity analysis programme will be used, and how it will be used.

Task 8:

The consultants should clearly outline in their Tender how this Task will be achieved, including how relevant national and international invasive marine species records and databases will be accessed.

Task 9:

The consultants should clearly outline in their Tender how the outputs of Tasks 1 to 8, and in particular Task 4, will be used to produce the risk profiles for each demonstration site, and what form these will take.

Task 10 & 11:

The consultants should clearly outline in their Tender how these Tasks will be achieved.

## **6. Time Frame, End Product and Reporting Procedure**

- The risk assessments will be conducted for each of the six demonstration sites in the second half of 2001 and into the first half of 2002. A detailed workplan and timeline will be proposed by the consultant in their Tender and the precise timing for each site will be refined through consultation with each country, once the contract is awarded.
- The end product of this consultancy will be the establishment of the databases, GIS's, multivariate environmental similarity analysis programmes and risk assessment outputs at each demonstration site, including training in their use.
- There will also be a report for each demonstration site which addresses as fully as possible all of the Tasks under section 4, consistent with all parts of these Terms of Reference and the



consultancy contract. Results presented should be supported by maps, figures, diagrams and tables here useful.

- Each report should be submitted to the PCU in draft form first, for review by the PCU and the demonstration site risk assessment team. The final report for each site will be submitted to the PCU within one month of the consultants receiving review comments.
- The PCU may arrange for peer review of the draft reports, to ensure scientific credibility and quality control.
- The final reports should be submitted to the PCU in both hard-copy and electronic form, including figures, images and data, ready for publication. The PCU will publish each final report in both English and the main language of the pilot country (if different).

## 7. Selection Criteria

- Cost effectiveness.
- Demonstrated record of *meeting deadlines* and *completing tasks within budget*.
- Extensive experience with the issue of *introduced marine species*.
- Extensive experience with the issue of *ballast water*.
- Extensive experience with *risk assessment* in relation to introduced marine species and ballast water.
- Demonstrated abilities in *literature search and review* and in identifying and obtaining reports, publications, information and data from sometimes obscure and difficult sources.
- Demonstrated skills in *information analysis and synthesis*.
- Experience in working in *developing countries*.
- Experience in training and *capacity building* in developing countries.
- Ability of the proposed *methods and workplan* to complete all Tasks satisfactorily.

## 8. Content of Tenders

The Tender should include the following:

- Total lump-sum price in US\$.D.
- Detailed cost break-down for all Tasks in US\$ (NB. Total budget must not exceed US\$250,000 and cost-effectiveness and competitiveness within this budget forms a primary selection criteria).
- Detailed workplan and provisional timeline for all Tasks outlined under section 4 above.
- Details of the methods proposed to achieve all Tasks, framed against each Task under section 4 above and consistent with section 5 above.

- CV's of each consultancy team member (maximum of 3 pages per person) (consultancy teams should be kept as small as possible).
- Details of the consultancy's professional indemnity and liability insurance and quality assurance procedures.

**Further Information**

Steve Raaymakers  
Technical Adviser  
Programme Coordination Unit  
Tel +44 (0)20 7587 3251  
Fax +44 (0)20 7587 3261  
Email [sraaymak@imo.org](mailto:sraaymak@imo.org)



## More Information?

Programme Coordination Unit  
**Global Ballast Water Management Programme**  
International Maritime Organization  
4 Albert Embankment  
London SE1 7SR United Kingdom

Tel: +44 (0)20 7587 3247 or 3251  
Fax: +44 (0)20 7587 3261  
Web: <http://globallast.imo.org>