

## Benthic Flux in a Tropical Estuary and Its role in the Ecosystem

Anil K. Pratihary\*<sup>1</sup>, S.W.A. Naqvi<sup>1</sup>, H. Naik<sup>1</sup>, B. R. Thorat<sup>1</sup>, G. Narvenkar<sup>1</sup>, B.R. Manjunatha<sup>2</sup> and V.P. Rao<sup>1</sup>

1. Chemical Oceanography Division, National Institute of Oceanography, Dona Paula, Goa- 403 004, India

Tel: +91-832-2450255, Fax: +91-832-2450607

2. Department of Marine Geology, Mangalore University, Mangalagangothri- 574 199, Karnataka, India

Tel: +91-824-2287389, Fax: +91-824-2287289

E-mail: omsrbmanju@yahoo.com

\*Corresponding author: anil\_pratihary@yahoo.co.in

### Abstract

*In-situ* measurements of benthic fluxes were made in the subtidal region of Mandovi Estuary during premonsoon and monsoon season to understand the role of sediment-water exchange processes in the estuarine ecosystem. Mandovi Estuary is a shallow, highly dynamic, macrotidal estuary which experiences marine condition in premonsoon and nearly fresh water condition in monsoon season. Benthic flux of nutrients exhibited strong seasonality being higher in premonsoon compared to monsoon season which explains the higher ecosystem productivity in the dry season in spite of negligible riverine nutrient input.  $\text{NH}_4^+$  was the major form of released N comprising 70-100% of DIN flux. Benthic respiration rate varied from -98.91 to -35.13  $\text{mmol m}^{-2} \text{d}^{-1}$ ,  $\text{NH}_4^+$  flux from 5.15 to 0.836  $\text{mmol m}^{-2} \text{d}^{-1}$ ,  $\text{NO}_3^- + \text{NO}_2^-$  from 0.06 to -1.06  $\text{mmol m}^{-2} \text{d}^{-1}$ , DIP from 0.12 to 0.23  $\text{mmol m}^{-2} \text{d}^{-1}$  and  $\text{SiO}_4^{4-}$  flux varied from 5.78 to 0.41  $\text{mmol m}^{-2} \text{d}^{-1}$  between premonsoon to monsoon period. The estuarine sediment acts as a net source of DIN, but changed to a net sink in monsoon. Variation in salinity seemed to control  $\text{NH}_4^+$  flux considerably. Macrofaunal activities especially bioturbation enhanced the *in-situ* observed fluxes by 2-25 times. The estuarine sediment was observed to be a huge reservoir of  $\text{NH}_4^+$ ,  $\text{PO}_4^{3-}$  and  $\text{SiO}_4^{4-}$  and acts as a net sink of combined N because of high rate of benthic denitrification as it removes 22% of riverine DIN influx thereby protecting the system from eutrofication and consequent degradation of the ecosystem. The estuarine sediment was responsible for 30-50% of the total community respiration. Benthic supply of DIN,  $\text{PO}_4^{3-}$  and  $\text{SiO}_4^{4-}$  can potentially meet 49 %, 25 % and 55 % of algal N, P and Si demand respectively in the Estuary. Based on these observations we hypothesize that it is mainly benthic  $\text{NH}_4^+$  efflux that sustains high estuarine productivity in the  $\text{NO}_3^-$  depleted dry season.

**Keywords:** Nutrients; Primary production; Denitrification; Bioturbation; Benthic flux; Mandovi Estuary (India, Goa)

## 1. Introduction:

Benthic realm is an integral and very important part of shallow water systems such as estuaries, lagoons and continental shelves. Unlike the open ocean, estuarine and coastal systems receive nutrients not only from riverine discharge, land run-off and atmospheric deposition, but also from underlying sediments. Thus coastal systems are much more productive as compared to the open ocean. Although continental marginal systems such as estuaries, nearshore and continental shelves occupy just about 10 % of the global oceanic area, between 30-50 % of the marine primary production occurs in these regions (Romankevich, 1984; Walsh, 1991) which also sustains about 90 % of the fisheries resource. Coastal and continental margin sediments receive about 80 % of the freshly produced organic matter that reaches the sediment in the world's oceans; this amounts to 10-50 % of the annual primary production in the overlying waters (Jørgensen, 1983). Estuarine sediments receive comparatively high concentrations of organic matter than the open ocean (Santschi et al., 1990) and the burial of plankton derived organic carbon in the shallow sediments has the potential to provide a significant sink for atmospheric CO<sub>2</sub>.

Microbially mediated benthic mineralization of this material is a major recycling pathway of biogenic elements. Transport of remineralised nutrients from sediment to water takes place mainly through molecular diffusion (Li & Gregory, 1974), macrobenthic activities (Kristensen, 1985), resuspension of surficial sediment (Hammond et al., 1977), transport through bubble tubes (Klump & Martens, 1983) and advective transport of porewater (Marinelli et al., 1998)

Benthic inputs can contribute significantly to the pelagic nutrient inventory and can potentially meet the algal nutrient demand in shallow environments (Callender & Hammond, 1982). Thus sediments play a significant role in the biogeochemistry of such systems. Without benthic supply of nutrients, a shallow system could lose its feedback and the primary production would solely be dependent on pelagic regeneration and thus the system would be as less productive as the open ocean (Rowe et al., 1975).

Several methods have been followed for direct measurement of benthic exchange of oxygen and nutrients during last three decades. Out of them mostly used method are *in-situ* incubation (Hammond et al., 1999; Jahnke et al., 2000) and intact core incubation (Hopkinson Jr et al., 2001; Sundback et al., 2003). However in estuarine systems *in-situ* incubation by benthic chamber method has been found to be the best and most sensitive technique for accurate measurement of benthic flux (Hammond et al., 1985).

Presence of Western Ghats results enormous rainfall along west coast of India during monsoon season. Goa receives an average rainfall of 3000 mm of which 80 % occurs in June-August. Estuaries along

Indian west coast receive large amount of fresh water in monsoon and river run-off supplies a large amount of nutrients to the coastal sea. However in non-monsoon periods these Estuaries remain tidally dominated due to negligible riverine flow thus becoming virtually a part of the coastal sea. The Mandovi Estuary of Goa has been subjected to numerous investigations that has led to a fairly good understanding of general physico-chemical-biological and hydrographical processes operating in the Estuary (Qasim & Sen Gupta, 1981; De Souza, 1983; Devassy & Goes, 1988; Ansari & Parulekar, 1993; Shetye et al., 1995; Pradeep Ram et al., 2003) and it is one of the very well studied estuarine systems in the country. Benthic-pelagic coupling assumes importance in such a shallow system to understand the functioning of its ecosystem. However benthic biogeochemical processes in this Estuary have not been given due attention in past. No systematic study has been undertaken so far to quantify benthic respiration rate, nutrient exchange rates and to understand their implications for primary productivity not only in this Estuary but also elsewhere along the west coast of India.

In order to fill up this gap, here, we present here the first ever results of benthic flux measurements along coastal environment of eastern Arabian Sea. The fluxes were measured by *in-situ* deployment of benthic chamber at a fixed site in Mandovi Estuary during three different seasons in 2004 especially targeting premonsoon and monsoon where salinity changes dramatically owing to varying riverine flow.

## **2. Materials and Methods**

### *2.1 Description of Study area*

Mandovi Estuary is a well mixed coastal plain Estuary situated between 15° 27' to 15° 31' N and longitude 73° 45' to 73° 59' E in Goa along west coast of India (Fig.1). The Mandovi River has its source in Western Ghats and runs ~75 Km through the state of Goa before falling into the Arabian Sea. The Estuary covers an area ~29 Km<sup>2</sup> and its width widens from 0.25 Km at the head to 3.2 Km at the mouth. The depth of the Estuary varies from 8-10 m at the mouth to <2 m at the fresh water end. The average depth of the Estuary is usually considered 4 m.

Basically the Estuary remains tidally dominated in dry season (October-May) as rain fall and riverine flow remain considerably low and saline water intrudes up to nearly 55 Km upstream. However in southwest monsoon season (June-September) Goa receives an average monthly rainfall of 500 mm during southwest monsoon. As a result the Estuary receives a large amount of fresh water from monsoonal precipitation and also due to land run-off from its catchment areas of 1150 Km<sup>2</sup> and forest land.

**[Position for Figure 1]**

For the details of physical, chemical and biological features of the estuary, the readers are suggested to refer Qasim & Sen Gupta (1981), De Souza, (1983), Parulekar & Dwivedi (1986), Devassy & Goes (1988), Ansari & Parulekar (1993), Shetye et al. (1995), Krishna Kumari et al. (2002), Pradeep Ram et al. (2003) and Qasim (2003)

## *2.2. Benthic Chamber Deployment and sampling*

An indigenously fabricated acrylic made benthic chamber (Fig. 2) was used for this flux study. Flanges are attached to two opposite outer walls of the chamber in order to restrict excess penetration of chamber into the sediment during emplacement. Average depth of penetration of the chamber to the sediment is 15 cm. The chamber covers an average area of 0.15 m<sup>2</sup> of the sediment surface during deployment. Total volume of the chamber is ~54 L and it encompasses an average ~31 L of water when deployed. Enclosed water was mixed by an acrylic stirrer mounted on a shaft fixed to the chamber through two opposite walls so that it remained approximately 15 cm above the sediment. The stirrer was coupled to a sprinkler (fixed outside) through the shaft. The sprinkler was connected to a pump which takes ambient water and pumps into the sprinkler. The water comes out through the sprinkler arms as fine jet thereby making the sprinkler rotate. To regulate speed of the stirrer, water flow into the sprinkler was controlled by a tap fixed to the outlet tube of the pump i.e. between the sprinkler and the pump. To decrease the stirring, more water was released through the tap and vice versa. The speed of the stirrer was adjusted so that it did not disturb the surficial sediment but mixed the enclosed water well.

### **[Position for Figure 2]**

The chamber was deployed by divers in the month of February, March, April and August in the subtidal zone of the Estuary i.e. at COP jetty, Panaji (Fig.1). This site was chosen because of availability of logistic facilities. During emplacement of the chamber, utmost care was taken to minimize disturbance of the surficial sediment. A pair of metallic weights was attached to two opposite sides of the chamber to prevent its lateral displacement by the current during incubation. During the incubation period ~1m water remained over the chamber even at the lowest tide. The tidal rhythm during the incubation period is presented (Fig.3). In April after first deployment, the chamber was again deployed ~5 m away from the regular site (away from the coast) to measure the spatial variability of fluxes.

### **[Position for Figure 3]**

Samples were collected by syringes through a nylon tubing inserted to the chamber and replaced by ambient water enclosed in a collapsible plastic bag attached to the outer wall of chamber. First sampling was done immediately after deployment of the chamber i.e. at time 0. Then sampling was continued in 4 hour interval for at least 24 hours. The sampling tube was ensured to be air bubble free before the

sampling. Samples for dissolved oxygen were collected in a gastight Hamilton glass syringe and were immediately fixed by adding Winkler's A and Winkler' B solutions (Grasshoff et al., 1983) through a fine needle attached to 1 ml BD syringe containing Winkler's solutions. Nutrient samples were collected through B-D plastic syringes and immediately kept at -20°C until analysis. At each sampling atmost 150ml of sample was withdrawn. So considering its replacement by same amount sample from the plastic bag, the dilution was 0.4 % which is very negligible as compared to volume of enclosed water.

### 2.3. Collection of sediment cores:

After 24-48 hrs of the *in-situ* incubation experiment, benthic chamber was removed and three sediment cores, one for porosity and other two for pore water profiling were collected from the same site in 30 cm long, 54 mm ID acrylic liners. These liners were inserted into sediment slowly with simultaneous removal of headspace air through a syringe attached to the top cap, in order to minimize compaction of sediment column. After collection, the cores were kept in dark and at 4 °C until further analyses. Sediment cores could not be collected in February due to logistic reasons.

### 2.4. Chemical Analysis:

Samples collected for various parameters, were analyzed within 24 hours after the collection. Dissolved oxygen was determined spectrophotometrically at wavelength 456 nm (Pai et al., 1993) by a *Shimadzu* UV-visible spectrophotometer with an accuracy of  $\pm 0.03 \mu\text{M}$ . Pore water oxygen profile was obtained by a *Unisense* oxygen profiler equipped with a microelectrode (Revsbech, 1983) which gives resolution in micrometer scale. Oxygen profiling could not be done in February, March and April due to logistic reason.  $\text{NO}_3^- + \text{NO}_2^-$ ,  $\text{NO}_2^-$ ,  $\text{PO}_4^{3-}$  and  $\text{SiO}_4^{4-}$  and  $\text{NH}_4^+$  were analyzed by a SKALAR segmented flow Autoanalyzer following colorimetric method (Grasshoff et al., 1983) and the precision of the measurement was  $\pm 0.06$ ,  $\pm 0.006$ ,  $\pm 0.06$ ,  $\pm 0.003$ ,  $\pm 0.01 \mu\text{M}$  respectively. Porosity was measured as the loss of sediment weight at 110 °C and was expressed as the ratio of volume of empty spaces in the sediment to the total volume of sediment. For extraction of porewater sediment cores were sectioned at each 1 cm interval and filled into  $\text{N}_2$  flushed centrifuge tubes inside a glove box, continuously being flushed with  $\text{N}_2$ . These sediments samples were then centrifuged at 4000 rpm for 20 minutes and after that pore water was immediately filtered and transferred to plastic vials in the glove box and analyzed for nutrients as described earlier. Porewater salinity was measured by a portable ATAGO salinometer (accuracy:  $\pm 0.1 \%$ ) after calibrating with deionised water and standard seawater (35 PSU). 10g of surficial sediment (upper 10cm) was oven dried and the granulometric analysis was carried out as per the methodology by Folk (1968).

### 2.5. Flux calculation

Dilution inside the chamber due to intrusion of water from the attached collapsible bag during sampling was negligible (0.4 %) and hence no correction was applied for the dilution. Moreover, since average change in the volume of water column at the end of the experiment was only 3 %, the plot between concentrations against time was found to be linear (Fig. 4, 5, 6 & 7) and thus benthic flux was calculated as follows.

$$F (\text{mmol m}^{-2} \text{d}^{-1}) = (V/A) \times (dC/dt) \times (24/1000)$$

Where  $V$  is the volume of the water in the chamber

$A$  is the surface area of the sediment enclosed in the chamber

$dC/dt$  is the slope of the linear regression of concentration ( $\mu\text{M}$ ) versus time plot.

As per the convention, here negative flux denotes flux from overlying water to sediment and positive flux denotes flux from sediment to overlying water.  $\text{NO}_3^-$  influx rate was considered as benthic denitrification rate.

## 3. Results:

### 3.1. Oxygen flux:

Oxygen uptake pattern remained nearly linear at the beginning of the experiment, but once oxygen level in overlying water comes down to 100  $\mu\text{M}$ , it started decreasing in a polynomial fashion (Fig.4a, 5a, 6a, 7a). The pattern has also been observed by Sundby et al. (1986) in Gullmarsfjorden and Revsbech et al. (1988) in Aarhus Bay. The polynomial fit described the concentration changes with time better than the logarithmic or linear fit. Though the oxygen concentration never increased towards the end of experiments as the polynomial fit showed in some cases, the flux calculation becomes easier using this equation. In this case the slope of the polynomial fit at time 0 ( $dC/dt_{t=0}$ ) was taken for flux calculation.

### [Position for Figure 4, 5, 6 & 7]

Dissolved oxygen flux was always directed towards the sediment during the study period. It increased from 63.37  $\text{mmol m}^{-2} \text{d}^{-1}$  (February) to a maximum value: 98.91  $\text{mmol m}^{-2} \text{d}^{-1}$  in (April) but decreased further to 35.13  $\text{mmol m}^{-2} \text{d}^{-1}$  (August). Oxygen influx did not show any significant correlation with oxygen concentration in the overlying water ( $r = -0.63$ ,  $p < 0.05$ ) (Fig.8a). Though pore water oxygen profiling could not be done in February, March and April, a ~0.5 cm thick brown (oxic) layer was conspicuous in the top part of the collected sediment by visual observation.

### 3.2. Nutrient fluxes

A very good linear correlation ( $r^2 > 0.9$ ) was observed between nutrient concentration and incubation time in most of the cases (Fig.4, 5, 6, 7). In August, because of some mechanical problem, the stirrer stopped for some time which probably resulted in a dip in the concentration between 16-32 h (Fig.7). This happened due to stagnation in the water which caused a vertical concentration gradient in the water column. However resumption of stirring afterwards again brought back the linearity in the trend.

$\text{NO}_3^-$  flux started from a low efflux in February but became downward from March onwards and it attained maximum negative value in August (Table.1). Benthic  $\text{NO}_3^-$  influx showed a significant positive correlation with  $\text{NO}_3^-$  concentration of overlying water ( $r = 0.99$ ,  $p > 0.001$ ; Fig. 8b). Similar correlation has also been observed by Boynton & Kemp (1985) in Chesapeake Bay and Niencheski & Jahnke (2002) in Pattos Lagoon.  $\text{NH}_4^+$  flux was always directed to the overlying water.  $\text{NH}_4^+$  efflux increased from February, attained peak in March and became lowest in August (Table.1).  $\text{NH}_4^+$  flux was not significantly correlated with  $\text{NH}_4^+$  concentration in the overlying water ( $r = 0.5$ ,  $p < 0.05$ ) (Fig.8c). DIN flux was the resultant effect of  $\text{NO}_3^- + \text{NO}_2^-$  and  $\text{NH}_4^+$  fluxes. It also increased from February, maximized in March and decreased slightly in April and attained lowest value in August (Table.1).

#### **[Position for Table 1]**

$\text{PO}_4^{3-}$  showed a positive flux in all the months. Flux did not undergo much change from February to April though it attained a peak in March but increased to a maximum value in August (Table.1) and like  $\text{NH}_4^+$  flux, it showed a very insignificant correlation ( $r = 0.5$ ,  $p < 0.05$ ) with  $\text{PO}_4^{3-}$  concentration of overlying water (Fig.8d).

#### **[Position for Figure 8]**

We did not observe a good correlation between  $\text{SiO}_4^{4-}$  concentration and incubation time in August (Fig.7f) which could be due to weakening of concentration gradient between surficial pore water and overlying water (as heavy riverine flow increased  $\text{SiO}_4^{4-}$  concentration considerably in the estuarine water) and turbidity. However significant correlation was observed in other months.  $\text{SiO}_4^{4-}$  always released to the overlying water in all the months. It increased modestly from February, reached maximum value in March, further decreased slightly in April and became lowest in August (Table 1). Interestingly, it showed a significant correlation ( $r = -0.85$ ,  $p > 0.05$ ) with  $\text{SiO}_4^{4-}$  concentration in the overlying water (Fig.8e)

### *3.3. Diffusive flux:*

The flux occurring by molecular diffusion induced by concentration gradient across sediment-water

interface is termed as the diffusive flux which was estimated using a modification of Fick's first law of diffusion appropriate for sediment (Berner, 1980)

$$F = -\phi \cdot D_s \cdot (\delta C / \delta x)_{x=0}$$

Where F is the diffusive flux ( $\text{mmol m}^{-2} \text{h}^{-1}$ )

$\phi$  is the the porosity of the surficial sediment (dimensionless),

$(\delta C / \delta x)_{x=0}$  is the concentration gradient at the sediment-water interface ( $\text{mmol/l/m}$ )

and  $D_s$  is the whole sediment diffusion coefficient after temperature correction and tortuosity ( $\theta$ ) (Krom & Berner, 1980).

$$D_s = D_0 / \theta^2$$

where  $\theta$  is sediment tortuosity and can be expressed in terms of porosity *i.e.*

$$\theta = (1 - \ln \phi^2) \text{ (Bourdreau, 1996)}$$

$D_0$  is the diffusion coefficient measured at infinite dilution (Bourdreau, 1997)

Diffusive fluxes calculated from pore water concentrations are presented in Table.1. Diffusive flux data are not available for February as the core was not collected.

Monthly variation of diffusive nutrient fluxes were mainly regulated by combined effect of porosity and water column and pore water nutrient concentration.  $\text{NO}_3^-$  influx increased to a maximum from March to August.  $\text{PO}_4^{3-}$  flux behaved similarly but the peak value in monsoon.  $\text{NH}_4^+$  value attained the lowest in August from the highest value in April.  $\text{SiO}_4^{4-}$  flux was highest in March and reached at  $0.26 \text{ mmol m}^{-2} \text{ d}^{-1}$  in August through a minimum in April.

### 3.4. Spatial variability of fluxes

Variation in uptake or release pattern of oxygen and nutrients between two site was found to be insignificant ( $p > 0.05$ ) except  $\text{PO}_4^{3-}$  which showed relatively significant ( $p = 0.02$ ) spatial variability (Fig. 9). 22-72 % variation in the flux rate was observed on spatial scale. Hammond (1985) observed a spatial variability of 20-40 % in benthic fluxes of nutrients over a few meters in San Fransisco Bay due to difference in macrofaunal abundance. Spatial variation in benthic exchange rates were also observed by Berelson et al. (1998) in Port Phillip Bay and Hopkinson Jr et al. (2001) on US continental Shelf which exists due to spatial heterogeneity of porosity, organic matter content and pore water concentrations of oxygen, nutrients and abundance of macrobenthos in sediments. High macrofaunal abundance during the premonsoon season in the estuarine sediment and their spatial variation (Ansari & Parulekar, 1993) may dominantly control the observed the spatial variation in benthic fluxes in the



Estuary.

**[Position for Figure 9]**

#### **4. Discussion**

##### *4.1. Benthic respiration rate (BRR)*

Benthic respiration includes both the oxygen consumption by aerobic organisms and microbial mediated oxidation of reduced compounds (Mackin & Swider, 1989) and closely reflect the rates of oxic and anoxic decomposition in the sediment overlain by oxic waters. BRR depends on factors such as oxygen content of overlying water, organic load, benthic biomass and temperature. Oxygen penetrates to a few mm in the estuarine and coastal sediments (Sørensen et al., 1984). The observed peak in oxygen flux in April can be explained as follows. The Estuary remains highly productive in premonsoon season (March-May). This could lead to high rate of sedimentation of organic debris and in turn increased labile organic content of the sediment. Trimmer et al. (1999) observed a substantial increase in benthic respiration rate following a spring bloom. Total organic carbon content of surficial sediment of the Estuary varies between 0.1-3% and the sediment becomes organic rich in premonsoon (Alagarsamy, 1991). Moreover temperature of the estuarine water reached to a peak value (31°C). Increase in temperature can significantly increase BRR (Bartoli et al., 1996). A significant positive correlation ( $r = 0.9$ ,  $p > 0.05$ ) was observed between BRR and temperature of estuarine water (Fig. 8f). So the high organic load and its subsequent decomposition stimulated by higher temperature seem to cause the higher BRR in premonsoon. Taking average of oxygen flux in all seasons, aerobic mineralization rate was calculated to be  $607.66 \mu\text{mol C m}^{-2} \text{ d}^{-1}$ . Pradeep Ram et al. (2003) reported the integrated community respiration rate to be  $75.3 \text{ mmol C m}^{-2} \text{ d}^{-1}$ . Thus corresponding pelagic respiration rate would be the same as C : O as 1 : 1 in the organic matter decomposition process (Alvarez-Borrego et al., 1975) considering low nitrification rate in the Estuary. As average oxygen flux during premonsoon was  $74.17 \text{ mmol m}^{-2} \text{ d}^{-1}$  it implies that benthic respiration shares 49.6 % of total community respiration. However it reduced to 29.6 % in monsoon. Boynton & Kemp (1985) observed sedimentary oxygen demand to be 25-48 % of the total community respiration in Chesapeake Bay.

##### *4.2. Nutrient Exchange across sediment-water interface*

Nutrient fluxes were found to be very significant particularly in dry season attaining maxima in March-April (Table 1). Except in February,  $\text{NH}_4^+$  was the only form of released DIN from sediment. Overall it comprised 70-100% of benthic DIN efflux.  $\text{NH}_4^+$  can constitute a substantial portion of benthic nitrogen flux in estuarine and coastal environments (Blackburn & Henriksen, 1983). Lower nitrification rate in this illuminated site (Horrigan et al., 1981) may partly account for such high  $\text{NH}_4^+$  flux. Water column

$\text{NH}_4^+$  concentration apparently did not control the flux as the latter was weakly correlated with the former parameter (Fig. 8c). However the lowest flux observed in August can be related to salinity change. The Estuary remains highly saline (33 PSU) in premonsoon but almost fresh water condition (1 PSU) prevailed in monsoon. We observed significant penetration of low saline water into the sediment. The porewater salinity steadily increased from 1 from interface to 10 at 20 cm (Fig.10c). This decrease in salinity could have profound effect on  $\text{NH}_4^+$  flux. Gardner et al. (1991) experimentally proved that increasing salinity can enhance benthic  $\text{NH}_4^+$  release. They explained that at low salinity condition a major portion of pore water  $\text{NH}_4^+$  remains bound to sediment particles as exchangeable  $\text{NH}_4^+$  and undergoes substantial nitrification in the upper oxic layer ultimately reducing benthic  $\text{NH}_4^+$  release.

Net DIN exchange across sediment-water interface was a balance between rate of benthic  $\text{NO}_3^-$  influx and rate of  $\text{NH}_4^+$  efflux. DIN flux underwent dramatic variation as it attained peak in March and became negative in August (Table 1). This indicated that the estuarine sediment was a net source of DIN in premonsoon and a sink in monsoon. But in both the seasons sediments behaved as a sink for  $\text{NO}_3^-$ . In August loss of DIN to the sediment was  $229 \mu\text{mol m}^{-2} \text{d}^{-1}$ . As the Estuary receives 10256 moles of DIN per day in monsoon period (<http://data.ecology.su.se/MNODE/Asia/India/Mandovi/Mandovibud.htm>) the loss of DIN through benthic denitrification was 22.3 % of the riverine DIN supply.

Variation in  $\text{PO}_4^{3-}$  concentration in the overlying water did not control the benthic  $\text{PO}_4^{3-}$  release (Fig.8d). Lessening of oxic layer (~2mm) and consequent reduction of Fe oxyhydroxides in monsoon season could be reason behind the higher phosphate release in monsoon. Low  $\text{SiO}_4^{4-}$  efflux in monsoon could be because of lessening of concentration gradient between porewater and overlying water since estuarine water was highly enriched with  $\text{SiO}_4^{4-}$  (89  $\mu\text{M}$ ).  $\text{SiO}_4^{4-}$  flux showed a significant negative correlation with water column silica concentration (Fig.8e). Similar trend was also observed by Niencheski & Jahnke (2002) in Patos Lagoon.

#### *4.3. Stoichiometry of fluxes*

A very important aspect of the mineralization process in the sediment is the release of nutrients back to the overlying water, which is essential for primary production and thus maintains the element cycles of the ocean. The ratio at which C, N and P are assimilated into the algal cell and the ratio, at which these biogenic elements are released back through remineralization, usually remain very close to the Redfield ratio in the water column in a steady state. Although the sinking organic matter to the sediment contains C, N and P in Redfield ratio, benthic release of these elements does not necessarily follow the same ratio because of fractionation (Suess & Muller, 1980), authigenic production or interaction with sedimentary solids (Suess, 1979) and other biogeochemical processes like benthic nitrification and

denitrification.

*In-situ* flux ratios of  $\text{NH}_4^+ : \text{PO}_4^{3-} : \text{SiO}_4^{4-}$  widely differs from that of diffusive fluxes in summer months (Table.2). This indicates the role of other factors particularly bioturbation in enhancing the measured fluxes. Such a large departure from the expected Redfield value (16:1) can be attributed to several geochemical processes which distort the release ratio such as adsorption of  $\text{NH}_4^+$  onto clay minerals (Rosenfeld, 1979), coupled nitrification and denitrification (Jenkins & Kemp, 1984) in the sediments, adsorption of  $\text{PO}_4^{3-}$  onto ferric oxides and also its co precipitation with ferric oxyhydroxides in the upper oxic zone of the sediment (Krom & Berner, 1980). The benthic flux ratio between  $\text{NH}_4^+$  and  $\text{PO}_4^{3-}$  varies from 3.5 in August to 39 in March. O:  $\text{NH}_4^+$  ratio varied from 7.1 to 29 in premonsoon but deviates considerably in August (60.5). Deviation of this ratio from the expected value (13.25) indicates the loss of  $\text{NH}_4^+$  in coupled nitrification-denitrification system in premonsoon but higher ratio in monsoon can be attributed to suppressed  $\text{NH}_4^+$  release due to reduced salinity (Gardner et al., 1991).  $\text{NH}_4^+ : \text{SiO}_4^{4-}$  shows a linear increase from 0.6 in February to 2.01 in August. The proximity of the ratio in premonsoon to its theoretical value (1:1) indicates that the Estuary was dominated by diatoms during this period but the population decreased towards August in turn reducing biogenic silica flux to the sediment. The decrease in diatom population has been observed in the Estuary by Devassy & Goes (1988). DIN:DIP ratio also showed a wide range of variation being high (24-31) during the premonsoon season but decreased to -1.7 in August showing net consumption of combined N and relatively higher release of  $\text{PO}_4^{3-}$  in monsoon. The increase in  $\text{NO}_3^-$  fuels higher denitrification rates and the decrease in salinity favors low benthic release of  $\text{NH}_4^+$  thereby making the estuarine sediment a net sink of N in monsoon.

#### **[Position for Table 2]**

#### *4.4. Pore water nutrients*

Pore water nutrient concentrations particularly in the upper sediment layer varied considerably from premonsoon (March-April) to monsoon (August). Variation was also observed between March to April.  $\text{NO}_3^-$  concentration in the pore water was low and did not vary considerably with depth (Fig. 10d). This also applies for  $\text{NH}_4^+$  and  $\text{SiO}_4^{4-}$ , particularly in March. But in April the observed trends were much regular for  $\text{NH}_4^+$  and  $\text{SiO}_4^{4-}$  and overall increasing trends with depth was noticed. In March pore water  $\text{NH}_4^+$  and  $\text{SiO}_4^{4-}$  concentration in the surficial sediment layer were found to be higher than those observed in April (Fig. 10f and 10h). This resulted in weaker concentration gradient between pore water and overlying water leading to lower diffusive flux. This agrees with the flux data that show decreases

in  $\text{NH}_4^+$  and  $\text{SiO}_4^{4-}$  efflux from March to April. Similarly there was negligible change in pore water  $\text{PO}_4^{3-}$  in the surficial layer between March to April (Fig. 10g) which could account for similar flux rates in these months. Irregular pattern of  $\text{NO}_3^-$ ,  $\text{NH}_4^+$  and  $\text{SiO}_4^{4-}$  distribution in the sediment column in March may be attributed to higher abundance of benthic macrofauna (Ansari & Parulekar, 1993) which probably proliferated in response to higher organic matter loading, following spring bloom in March (Pradeep Ram et al., 2003). These benthic organisms create burrows in the sediment through which the oxic overlying water penetrates to the deeper sediment layer. Some part of  $\text{NH}_4^+$  must have been nitrified to  $\text{NO}_3^-$  which is reflected in sudden increase in  $\text{NO}_3^-$  and decrease in  $\text{NH}_4^+$  in the pore water. Other benthos mix up the upper few cm of sediment. Regular increasing trend of  $\text{NH}_4^+$  and  $\text{SiO}_4^{4-}$  in April may be due to relative decrease in macrofaunal population probably because of decrease in fresh organic matter flux to the sediment. However pore water concentration of  $\text{NH}_4^+$  and  $\text{SiO}_4^{4-}$  showed overall increases and  $\text{NO}_3^- + \text{NO}_2^-$  exhibited overall decrease with depth in both the months. Basically, apart from the vertical trend, sharp gradient was between pore water concentration of  $\text{NH}_4^+$ ,  $\text{PO}_4^{3-}$  and  $\text{SiO}_4^{4-}$  and there water column concentration that induced diffusive flux from sediment to water.

**[Position for Figure 10]**

In august increase in river flow resulted almost a fresh water condition in the Estuary and consequently this affected the pore water profile. Salinity of the pore water was considerably low which indicates significant penetration of low saline riverine water to the sediment. Porosity increased considerably in the sediment layer being 98 % at the surface (Fig. 10a) because of significant increase in silt and clay content in the sediment (Table 3) because of higher riverine flow in monsoon.

**[Position for Table 3]**

$\text{NO}_3^-$  was depleted within 1 cm indicating high benthic denitrification.  $\text{NO}_2^-$  was low between 1-4 cm, but sharp peaks were observed below that which probably due to bioirrigation resulting in nitrification of pore water  $\text{NH}_4^+$ . Substantial decrease in  $\text{NH}_4^+$  concentration was evident as compared to premonsoon values. This probably happened due to considerable decrease in pore water salinity (Gardner et al., 1991) which in turn resulted in a very low  $\text{NH}_4^+$  flux in August. Considerable increase in pore water  $\text{NH}_4^+$  concentration owing to increase in bottom water salinity and consequent enhancement in benthic  $\text{NH}_4^+$  release has also been observed in Parker Estuary (Hopkinson Jr et al., 1999).  $\text{PO}_4^{3-}$  and  $\text{SiO}_4^{4-}$  showed an approximately linear increase up to 4 cm but showed peaks below at same depth interval which could be because of macrobenthic activities. Pore water  $\text{PO}_4^{3-}$  concentration increased significantly in August probably due to the greater reductive dissolution of Fe-oxyhydroxides

as oxygen penetration was limited to 2 mm which in turn explains the higher flux in monsoon. Pore water  $\text{SiO}_4^{4-}$  did not undergo much change from April to August in the upper layer however the significant increase in overlying water in August reduced the concentration gradient across sediment-water interface which resulted in much lower flux. Though the sediment became highly porous in monsoon other biogeochemical factors suppressed its effect resulting higher  $\text{NO}_3^-$  and  $\text{PO}_4^{3-}$  flux and much lower  $\text{NH}_4^+$  and  $\text{SiO}_4^{4-}$  release. However the estuarine sediment was found to be a huge reservoir of  $\text{NH}_4^+$ ,  $\text{PO}_4^{3-}$  and  $\text{SiO}_4^{4-}$  in all the seasons.

#### 4.5. Diffusive flux versus In-situ flux

Diffusive fluxes calculated from pore water concentrations are lower than those measured by direct incubation of sediment-water by benthic chamber. This indicates an apparent enhancement of benthic exchange rate across the sediment-water interface as observed by McCaffrey et al. (1980) in Narraganset Bay. Various possible mechanisms that may be responsible for increasing the fluxes, are physical stirring by currents (Hammond et al., 1977), benthic macrofaunal activity *i.e.* bioirrigation and bioturbation (Mortimer et al., 1999), transport through abiogenic bubble tube structures (Martens et al., 1980) and advective flows arising from bottom unevenness (Huettel et al., 2003). Physical reworking of the sediments whether by benthic organisms or waves and tidal, can also enhance the exchange of nutrients with the overlying water by increasing the mixing intensity of the sediment and pore water with the overlying water (Santschi et al., 1990). Directly measured fluxes can be 2-10 times greater than the calculated diffusive fluxes under oxic condition, but under anoxic condition, diffusive fluxes can be closer to the measured benthic fluxes (Rutgers van der Loeff et al., 1984). Studies carried out by Ansari et al. (1986) and Ansari & Parulekar (1993) show that sediments of the Mandovi Estuary are inhabited by several groups of benthic macrofauna and meiofauna such as polychaetes, copepods and tubellarians with the highest abundance (60 %) in the top 0-2 cm of the sediment. They found faunal population showing pronounced seasonality with maximal population during premonsoon and post monsoon periods in response to increased salinity. Burrows created by benthic organisms were also conspicuous by visual observation at the chamber deployment site in March and April. Above authors reported an average density of the meiofauna  $1702 \times 10^3/\text{m}^2$  at a station very close to the deployment site. High rate of bioturbation and bioirrigation by such a large population of benthic organisms in the estuarine sediment seems to make *in-situ* measured flux rate much higher than the diffusive flux. In March diffusive flux contributed 4.8 % of  $\text{NO}_3^-$ , 38.9 % of  $\text{NH}_4^+$ , 12.3 % of  $\text{PO}_4^{3-}$  and 21 % of  $\text{SiO}_4^{4-}$  to the corresponding *in-situ* measured fluxes. In April diffusive flux of  $\text{NO}_3^-$ ,  $\text{NH}_4^+$ ,  $\text{PO}_4^{3-}$  &  $\text{SiO}_4^{4-}$  were 6.7%, 64.5 %, 14 % and 5.3 % of the corresponding *in-situ* fluxes respectively. In August diffusive fluxes of  $\text{NO}_3^-$ ,  $\text{NH}_4^+$ ,  $\text{PO}_4^{3-}$  and  $\text{SiO}_4^{4-}$  contributed respectively 3.9 %, 46 %, 64.2 % and 62.7 % to the

corresponding measured fluxes. Callender & Hammond (1982) found diffusive fluxes of  $\text{NH}_4^+$ ,  $\text{PO}_4^{3-}$  and  $\text{SiO}_4^{4-}$  to be 66 %, 30 % and 15 % of the corresponding *in-situ* measured flux rates in Chesapeake Bay. Several other authors such as McCaffrey et al. (1980), Hammond et al. (1985) and Miller-Way et al. (1994) also reported similar results. Other factors such as advective flow and transport through bubble tubes could possibly enhance the flux. The enhancement factors (ratios between measured fluxes and calculated diffusive fluxes) were 18.5, 2.56, 8.12 and 4.73 for  $\text{NO}_3^-$ ,  $\text{NH}_4^+$ ,  $\text{PO}_4^{3-}$  and  $\text{SiO}_4^{4-}$  respectively in March and 14.85, 1.55, 7.05, 18.65 for  $\text{NO}_3^-$ ,  $\text{NH}_4^+$ ,  $\text{PO}_4^{3-}$  and  $\text{SiO}_4^{4-}$  respectively in April. Fluxes of  $\text{NO}_3^-$ ,  $\text{NH}_4^+$ ,  $\text{PO}_4^{3-}$  and  $\text{SiO}_4^{4-}$  were enhanced by 25.4, 2.17, 1.55, 1.59 times in August which indicates that macrofaunal activities were still prevalent in monsoon to a smaller extent. Callender & Hammond (1982) reported a 20-fold increase in ammonium and silicate fluxes due to bioirrigation by polychaetes and oligochaetes in Potomac Estuary. Kristensen et al. (1991) observed that macrofaunal activities elevated the fluxes of DIN compounds 2-4 times in an Estuary near Norsminde fjord. Pelegri et al. (1994) found a 5 fold increase in  $\text{NH}_4^+$  and  $\text{NO}_3^-$  fluxes in Norsminde fjord. Qu et al. (2005) also observed 1.9, 1.1 and 4.4 times enhancement of  $\text{NO}_3^- + \text{NO}_2^-$ ,  $\text{NH}_4^+$  and  $\text{PO}_4^{3-}$  flux respectively in Lake Illawara.

#### 4.6. Benthic turnover time

The turnover time is the time required in days for benthic fluxes to replenish water column concentration of a nutrient and is calculated by dividing water column inventory of a nutrient by benthic flux of that nutrient. Average turnover time of DIN in premonsoon period was calculated to be 6.3 days (Table. 4) which means that the benthic flux can replenish the whole pelagic DIN inventory in ~6 days. But since the net DIN flux during the monsoon season is directed to the sediment it could not be calculated for DIN as a whole. However if only  $\text{NH}_4^+$  efflux is taken into consideration without considering high downward flux of  $\text{NO}_3^- + \text{NO}_2^-$  during the monsoon, it can replace the water column N stock in ~13 days. Since  $\text{NH}_4^+$  comprises a dominant fraction of net DIN efflux in premonsoon with an average turn over time 5.6 days, it has a high potential to supply a major part of N required by phytoplankton in that period. Since DIN flux was negative in monsoon, its turnover time could not be calculated. The turnover time for  $\text{PO}_4^{3-}$  and  $\text{SiO}_4^{4-}$  vary considerably from an average value of 26.6 and 10.2 days in premonsoon to ~6 and 864 days in the monsoon season respectively. The long turnover time of  $\text{SiO}_4^{4-}$  in monsoon is due to higher silicate in the water column supplied through riverine flow and consequent low benthic  $\text{SiO}_4^{4-}$  release. Callender & Hammond (1982) observed the benthic turnover times of N, P and Si to be 14, 26 and 3 days respectively in Potomac Estuary.

**[Position for Table 4]**

#### 4.7. Coupling of Benthic flux and primary productivity

The Mandovi Estuary has been found to be net autotrophic in premonsoon and post monsoon season and net heterotrophic in monsoon season (Pradeep Ram et al., 2003). Excessive loading of allochthonous organic matter entering in the Estuary through heavy land and river runoff and significant drop in primary production due to high turbidity and cloud cover during monsoon period, cause community respiration to exceed gross primary production. Net ecosystem production (NEP) in the Estuary is 54, -34 and 47 mmol C m<sup>-2</sup> d<sup>-1</sup> in the premonsoon, monsoon and post monsoon season respectively (Pradeep Ram et al., 2003). Assuming overall dominance of diatoms in the system and considering average benthic fluxes for the premonsoon, the contribution of benthic fluxes to primary production was calculated and is presented in *Table 5*. Similarly nutrient demand in gross primary productivity (GPP) and contribution of benthic fluxes in premonsoon and monsoon are also presented in in the table. During the premonsoon period, benthic efflux can meet 49 %, 25 % and 55 % of the N, P and Si demands of algal community respectively in the Estuary. However since the gross primary production (GPP) is 112.4 mmol m<sup>-2</sup> d<sup>-1</sup> in premonsoon (Pradeep Ram et al., 2003), the contributions of DIN, PO<sub>4</sub><sup>3-</sup> and SiO<sub>4</sub><sup>4-</sup> fluxes were found to be 23 %, 12 % and 26 % respectively (*Table.5*). Callender & Hammond (1982) found that benthic NH<sub>4</sub><sup>+</sup> and PO<sub>4</sub><sup>3-</sup> supply can support 35 % and 27 % of the gross primary production in the Potomac Estuary. Billen (1978) reported that benthic N release could meet 75 % of phytoplankton nitrogen demand in the North Sea. In the Narragansett Bay benthic NH<sub>4</sub><sup>+</sup> and PO<sub>4</sub><sup>3-</sup> efflux contributed 25 % and 50 % of N and P requirements for primary production (Nixon, 1981). Similarly, Boynton et al. (1980a) concluded that benthic flux of NH<sub>4</sub><sup>+</sup> and PO<sub>4</sub><sup>3-</sup> could supply between 0-190 % and 52-330 % of the estimated daily algal N and P demands in the Patuxent Estuary. However since in the monsoon season, there is net respiration (Pradeep Ram et al., 2003), net DIN flux becomes negative and SiO<sub>4</sub><sup>4-</sup> flux is suppressed considerably because of high riverine SiO<sub>4</sub><sup>4-</sup> input. Though PO<sub>4</sub><sup>3-</sup> flux remains significant, the released PO<sub>4</sub><sup>3-</sup> remains unutilized owing prevailing unfavorable condition for algal productivity. Only it enriches the pelagic P inventory of the estuarine water column.

#### **[Position for Table 5]**

#### 4.8. Ecological significance of benthic fluxes in the Estuary:

One of the most striking features of the Mandovi Estuary is strong seasonality i.e. during dry season (October-May) the river flow is almost negligible and the tidal domination makes the Estuary an inseparable part of the coastal sea and whereas during wet season (June-September), on the other hand, the Estuary becomes almost like a freshwater body. Heavy riverine discharge brings in large amounts of nutrients not only to the Estuary but also to the coastal sea. Thus the estuarine system remains well

coupled to the adjacent coastal system throughout the year and seasonally contrasting features can exert a large impact on the estuarine and coastal biogeochemistry. Since similar physical-hydrographical conditions prevail in other parts of the west coast, Mandovi Estuary represents of average biogeochemical condition of coastal ecosystems of western India.

Benthic fluxes of dissolved oxygen and nutrients appear to be controlled mainly by temperature, river runoff and activities of benthic organisms. Large variations in these parameters/processes on the annual scale introduce large seasonality in the fluxes, with the largest difference occurring between the premonsoon and monsoon seasons. The fluxes attained maxima in April and became negligible when peak monsoon conditions prevailed in the Estuary which indicates the possible role of fresh water flow, temperature and labile organic load and macrobenthic activities.

Higher fluxes of nutrients in premonsoon shows the efficiency of remineralization of planktonic organic matter in the sediment which is essential for sustenance of estuarine productivity particularly in dry season i.e. 2/3 of a year. Though the calculated turn over time of  $\text{NH}_4^+$ ,  $\text{PO}_4^{3-}$  and  $\text{SiO}_4^{4-}$  (6, 26 & 10 days respectively) remain slightly long due to assumption of steady state condition, the benthic released nutrients could quickly be distributed in the water column as the Estuary remains well mixed in this period. Benthic nutrient fluxes show a huge potential in contributing to net ecosystem productivity particularly in pre-monsoon period when algal nutrient demand remains high and riverine nutrient supply remains negligible thereby preventing estuarine productivity from nutrient limitation.

Though the Estuary remains almost depleted in  $\text{NO}_3^-$  except in monsoon, still the system remains more productive in dry season. Benthic fluxes also shows that the estuarine sediment acts as a sink (or a very minor source) of  $\text{NO}_3^-$  but a major source of  $\text{NH}_4^+$  in this period which implies that the source of N to the phytoplankton, is  $\text{NH}_4^+$  rather than  $\text{NO}_3^-$  (as previously thought). Unfortunately no seasonal data on  $\text{NH}_4^+$  in the estuarine water is available. Our observation reveals that benthic  $\text{NH}_4^+$  flux appears to satisfy algal N demand and sustains estuarine productivity in non-monsoon period. Since diatom which mainly takes up  $\text{NO}_3^-$ , dominates the estuarine water, it is perplexing how it thrives in such a low  $\text{NO}_3^-$  condition. Presumably it takes up  $\text{NH}_4^+$  which is the single major N source in dry season. This remains a subject of future research.

The downward flux of  $\text{NO}_3^-$  in premonsoon and monsoon season imply that the estuarine sediments serve as a significant sink of  $\text{NO}_3^-$  (especially when the overlying water is  $\text{NO}_3^-$ -rich) in most part of the year. Thus the estuarine sediments hold the potential to get rid, at least partially, of the extra load of  $\text{NO}_3^-$  entering the Estuary from anthropogenic sources, river discharge or land run off thereby preventing eutrophication and consequent ecosystem degradation.



## 5. Conclusions:

Benthic respiration rate and fluxes of nutrients across sediment-water interface in the Mandovi Estuary exhibit strong seasonality with large differences between the premonsoon and monsoon seasons owing to variations in temperature, salinity, macrobenthic activities, etc. Fluxes of oxygen and nutrients attain peak values during premonsoon and reach minima in the monsoon season. Benthic respiration rate comprise ~30-50 % of the total community respiration and 607.66  $\mu\text{mole}$  of organic carbon is aerobically remineralized per square meter in a day.

Ammonium is the dominant species of benthic regenerated N in premonsoon comprising 70-100 % of the benthic DIN flux. The estuarine sediment serves as net source of DIN during the premonsoon period mainly in the form of  $\text{NH}_4^+$ , but act as a net sink of DIN in the monsoon season owing to suppressed flux of  $\text{NH}_4^+$  and enhanced benthic denitrification. The net loss of DIN to the sediment is found to be 229  $\mu\text{mol m}^{-2}\text{d}^{-1}$  during the monsoon season which is 22 % of the riverine DIN supply. The estuarine sediment seems to be an active site for benthic denitrification removing  $\text{NO}_3^-$  and  $\text{NO}_2^-$  at a rate of 1065  $\mu\text{mol m}^{-2}\text{d}^{-1}$  and has a potential to remove excess  $\text{NO}_3^-$  added to the Estuary due to natural or anthropogenic processes during other seasons as well.  $\text{NO}_3^-$  and  $\text{SiO}_4^{4-}$  fluxes were strongly influenced by the overlying water concentration whereas  $\text{NH}_4^+$  and  $\text{PO}_4^{3-}$  seem to be mainly controlled by salinity and dissolution of Fe oxyhydroxides respectively.

Macrobenthic activities could cause ~2-25 times enhancement in nutrient fluxes.

The estuarine sediment efficiently recycles the organic matter received from the water column during the premonsoon as nitrogen, phosphorus and silicate are recycled from sediment into the water column on time scales of 6, 26 and 10 days respectively.

The estuarine sediment supplies a major fraction of the nutrients utilized by primary producers in the water column. The coupling of benthic fluxes with net estuarine productivity appeared to be very significant as benthic supply has potential of meeting 49 %, 25 % and 55 % of algal N, P and Si demands, respectively, during the most productive season of the year. ■

## Acknowledgements

The authors would like to thank Captain of CRV *Sagar Sukti* and Captain of Port, Panjim for their logistic support for the *in-situ* incubation experiment. We are grateful to the Director of National Institute of Oceanography for providing adequate technical and laboratory facilities for the study. We thank Dr. Siby Kurian for the proofreading of the manuscript. We are also thankful to Dr. M.D. Kumar and Dr. P.V. Narvekar for his valuable support and H.S. Dalvi for his enormous help during field incubation experiments. We thank Dr. Pratima Kessarkar and Shynu for their help in the Granulometric analyses. We thank Dr. B.N. Nath for the valuable discussion. We are thankful to an anonymous reviewer for the critical review of the manuscript. This study was carried out with the financial support of Council of Scientific and Industrial Research (CSIR), India.

## References

- Alagarsamy, R., 1991. Organic carbon in the sediments of Mandovi Estuary, Goa. *Indian Journal of Marine Science* 20, 221–222.
- Alvarez-Borrego, S., Guthrie, D., Culberson, C.H., Park, P.K., 1975. Test of Redfield's model for oxygen-nutrient relationships using regression analysis. *Limnology and Oceanography* 20, 705-805.
- Ansari, Z. A., Parulekar, A.H., 1993. Distribution, abundance and ecology of the meiofauna, in a tropical estuary along the west coast of India. *Hydrobiologia* 262, 47-56.
- Ansari, Z.A., Ingole B.S., Banerjee G., Parulekar, A.H., 1986. Spatial and temporal changes in benthic macrofauna from Mandovi and Zuari estuaries of Goa, West coast of India. *Indian Journal of Marine Science* 15, 223-229.
- Bartoli, M., Cattadori M., Giodani, G., Viaroli, P., 1996. Benthic oxygen respiration, ammonium and phosphorus regeneration in surficial sediments of the Sacca di Gorro (northern Italy) and two French coastal lagoons: a comparative study. *Hydrobiologia* 329, 143-159.
- Berelson, W.M., Heggie D., Longmore A., Kilgore T., Nicholson G., Skyring, G., 1998. Benthic nutrient recycling in Port Phillip Bay, Australia. *Estuarine Coastal and Shelf Science* 46, 917–934.
- Berner, R. A., 1980. *Early diagenesis: A theoretical approach*. Princeton University press, 241 pp.
- Billen, G., 1978. A budget nitrogen recycling in North Sea sediments of the Belgian coast. *Estuarine Coastal Marine Science* 7, 127-146.
- Blackburn, T. H., Henriksen, K., 1983. Nitrogen cycling in different types of sediments from Danish waters. *Limnology and Oceanography* 28, 477–493.
- Boudreau, B.P., 1996. The Diffusive Tortuosity and Porosity of Fine-Grained Sediments. *Geochimica et Cosmochimica Acta* 60, 3139-3142.
- Boudreau, B.P., 1997. *Digenetic models and their implementation*. Springer-Verlag, Berlin, 414 pp.
- Boynton, W. R., Kemp, W. M., 1985. Nutrient regeneration and oxygen consumption by sediments along an estuarine salinity gradient. *Marine Ecology Progress Series* 23, 45–55.
- Boynton, W. R., Kemp, W. M., Osborne C. G., 1980. Nutrient fluxes across the sediment-water interface in the turbid zone of a coastal plain Estuary. In V. S.Kennedy (ed.), *Estuarine Perspectives*. Academic Press. New York, 93-109.
- Callender, E., Hammond, D.E., 1982. Nutrient exchange across the sediment water interface in the Potomac river Estuary. *Estuarine Coastal and Shelf Science* 15, 395-430.
- De Sousa, S.N., 1983. Studies on the behaviour of nutrients in the Mandovi Estuary during premonsoon. *Estuarine Coastal Shelf Science* 16, 299-308.
- Devassy, V.P., Bhargava, R.M.S. 1978. Diel changes in phytoplankton population in the Mandovi and Zuari estuaries of Goa. *Mahasagar-Bulletin of National Institute of Oceanography* 11, 195-199.
- Devassy, V.P., Goes, J.I., 1988. Phytoplankton community structure and succession in a tropical estuarine complex (central west coast of India). *Estuarine Coastal Shelf Science* 27, 671-685.
- Folk, R.L., 1968. *Petrology of sedimentary rocks*. Hemphillis, Austin & R.M.S., Texas, 170 pp.

- Gardner, W. S., Seizinger, S., Malczyk, J. M., 1991. The effects of sea-salts on the forms of nitrogen released from estuarine and fresh water sediments: does iron pairing affect ammonium flux? *Estuaries* 14, 157-166.
- Grasshoff, K., Ehrhardt, M., Kremling, K., 1983. *Methods of Seawater Analysis*, Verlag Chemie, 419 pp.
- Hammond, D. E., Simpson, H. J., Mathieu G., 1977. Radon-222 distribution and transport across the sediment-water interface in the Hudson River Estuary. *Journal of Geophysical Research* 82, 3913–3920.
- Hammond, D. E., Fuller, C., Harmon, D., Hartman, B., Korosec, M., Miller, L., Rea, R., Berelson, W., Hager, S., 1985. Benthic fluxes in San Francisco Bay, *Hydrobiologia* 129, 69–90.
- Hammond, D.E., Giordani, P., Berelson, W., Poletti, R., 1999. Diagenesis of carbon and nutrients in the sediments of the Northern Adriatic Sea, *Marine Chemistry* 66, 53-79.
- Hopkinson Jr, C.S., Giblin, A.E., Tucker, J., 2001. Benthic metabolism and nutrient regeneration on the continental shelf of Eastern Massachusetts, USA. *Marine Ecology Progress Series* 224, 1-19
- Horrigan, S. G., Carlucci, A. F., Williams, P. M., 1981. Light inhibition of nitrification in sea surface films. *Journal of Marine Research* 39. 557-565.
- Huettel, M., Roy, H., Precht, E., Ehrenhauss, S., 2003. Hydrodynamical impact on biogeochemical processes in aquatic sediments. *Hydrobiologia* 494, 231-236.
- Jahnke, R.A., Nelson, J.R., Marinelli, R.L., Eckman, J.E., 2000. Benthic flux of biogenic elements on the Southeastern US continental shelf: influence of pore water advective transport and benthic microalgae. *Continental Shelf Research* 20, 109-127.
- Jenkins, M. C., Kemp, W. M., 1984. The coupling of nitrification and denitrification in two estuarine sediments. *Limnology and Oceanography* 29, 609-619.
- Jørgensen, B. B., 1983. Processes at the sediment–water interface. In Bolin, B. & R. B. Cook (eds), *The Major Biogeochemical Cycles and Their Interactions*. SCOPE 21, Stockholm: 477–509.
- Klump, J.V., Martens, C.S., 1983. Benthic Nitrogen regeneration. In: Carpenter, E.J., and Capone, D.G. (eds), *Nitrogen in the Marine Environment*. Academic Press, New York. 411-457.
- Krishna kumari, L., Bhattathiri, P.M.A., Matondkar, S.G.P., John, J., 2002. Primary productivity in Mandovi-Zuari estuaries in Goa. *Journal of Marine Biological Association of India* 44, 1-13.
- Kristensen, E., 1985. Oxygen and inorganic nitrogen exchange in a *Nereis virens* (Polychaeta) bioturbated sediment–water system. *Journal of Coastal Research* 1, 109–116.
- Kristensen, E., Jensen, M.H., Aller, R.C., Robert, C., 1991. Direct measurement of dissolved inorganic nitrogen exchange and denitrification in individual polychaete (*Nereis virens*) burrows. *Journal of Marine Research* 49, 355-377.
- Krom, M.D., Berner, R.A., 1980. Adsorption of Phosphate in Anoxic Marine Sediments, *Limnology and Oceanography* 25, 797-806.
- Li, Y.H., Gregory, S., 1974. Diffusion of ions in seawater. *Geochimica et Cosmochimica Acta*, 38, 703-714.
- Mackin, J.E., Swider, K.T., 1989. Organic matter decomposition pathways and oxygen consumption in coastal marine sediments. *Journal of Marine Research* 47, 681-716.
- Marinelli, R.L., Jahnke, R.A., Craven, D.B., Nelson, J.R., Eckman, J.E., 1998. Sediment nutrient dynamics on the South Atlantic Bight continental shelf, *Limnology and Oceanography* 43, 1305-1320.

- Martens, C.S., Kipphut, G. W., Klump, J. V., 1980. Sediment-water chemical exchange in the coastal zone traced by in situ radon-222 flux measurements, *Science* 208, 285-288.
- McCaffrey, R.J., Myers, A.C., Davey, E., Morrison, G., Bender, M., Luedtke, N., Cullen, D., Froelich, P., Klinkhammer, G., 1980. The relationship between porewater chemistry and benthic fluxes of nutrients and manganese in Narragansett Bay, Rhode Island. *Limnology and Oceanography* 25, 31-44.
- Miller-Way, T., Boland, G., Rowe, G., Twilley, R., 1994. Sediment oxygen consumption and benthic nutrient fluxes on the Louisiana continental shelf: A methodological comparison. *Estuaries* 17, 809-815.
- Mortimer, R.J.G., Davey, J.T., Krom, M.D., Watson, P.G., Frickers, P.E., Clifton, R.J., 1991. The effect of macrofauna on porewater profiles and nutrient fluxes in the intertidal zone of the Humber Estuary. *Estuarine, Coastal and Shelf science* 48, 683-699.
- Niencheski, L.F., Jahnke, R.A., 2002. Benthic respiration and inorganic nutrients in the estuarine region of Patos Lagoon (Brazil). *Aquatic Geochemistry* 8, 135-152.
- Nixon, S.W., 1981. Remineralization and nutrient cycling in coastal marine ecosystems. Nutrient enrichment in Estuaries, Neilson B. and L.E., Cronin (eds). Humana press, Clifton, N.J., 111-138.
- Pai, S., Gong, G., Liu, K., 1993. Determination of dissolved oxygen in seawater by direct spectrophotometry of total iodine. *Marine Chemistry* 41, 343-351.
- Parulekar, A.H., Dwivedi, S.N., 1974. Benthic studies in Goa estuaries: Part I - Standing crop and faunal composition in relation to bottom salinity distribution and substratum characteristics in the Estuary of Mandovi River. *Indian Journal of Marine Science*, 3, 41-45.
- Pegleri S.P., Nielsen, L.P., Blackburn, T.H., 1994. Denitrification in estuarine sediment stimulated by the irrigation activity of the amphipod *Corophium volutator*. *Marine Ecology Progress Series* 105, 285-290.
- Pradeep Ram, A.S., Nair, S., Chandramohan, D., 2003. Seasonal shift in net ecosystem production in a tropical Estuary. *Limnology and Oceanography* 48, 1601-1607.
- Qasim, S.Z., Sen Gupta, R., 1981. Environmental characteristics of the Mandovi-Zuari estuarine system in Goa, *Estuarine Coastal Marine Science*, 13, 557-578.
- Qu, W., Morrison, R.J., West, R. J., Su, C., 2005. Diagenetic stoichiometry and benthic nutrient fluxes at the sediment-water interface of Lake Illawarra, Australia, *Hydrobiologia* 537, 249-264.
- Redfield, A.C., Ketchum, B.H., Richards, F.A., 1963. The influence of organisms on the composition of seawater. In: M.N. Hill, (ed.), *The Sea*, Vol. 2, Interscience, New York, 26-77.
- Revsbech, N. P., 1983. *In situ* measurement of oxygen profiles of sediments by use of oxygen microelectrodes. In: E. Gnaiger & H. Forstner (eds), *Polarographic Oxygen Sensors*. Springer-Verlag, Heidelberg: 265-273.
- Revsbech, N. P., Nielsen, L. P., Christensen, P. B., Sørensen, J., 1988. Combined oxygen and nitrous oxide micro sensor for denitrification studies. *Applied Environmental Microbiology* 54, 2245-2249.
- Romankevich, E. A., 1984. *Geochemistry of organic matter in the ocean*. Springer-Verlag, Berlin, 334 pp.
- Rosenfeld, J. K., 1979. Ammonium adsorption in near shore anoxic sediments. *Limnology and Oceanography* 24, 356-364.
- Rowe, G.T., Clifford, C.H., Smith Jr., K.L., 1975. Benthic nutrient regeneration and its coupling to primary productivity in coastal waters, *Nature* 255, 215-217.

- Rutgers van der Loeff, M. M., Anderson, L. G., Hall, P. O. J., Iverfeldt, A., Josefson, A. B., Sundby, B., Westerlund, S. F. G., 1984. The asphyxiation technique: an approach to distinguishing between molecular diffusion and biologically mediated transport at the sediment-water interface, *Limnology and Oceanography* 29, 675–686.
- Santschi, P.H., Hoehener, P., Benoit, G., Brink, M.B., 1990. Chemical processes at the sediment–water interface, *Marine Chemistry* 30, 69–315.
- Shetye, S. R., Gouveia, A. D., Singbal, S. Y., Naik, C. G., Sundar, D., Michael, G. S., Nampoothiri, G. 1995. Propagation of tides in the Mandovi–Zuari estuarine network. *Proceedings of the Indian Academy of Sciences (Earth & Planet Sciences)* 104, 667–682.
- Sørensen, J., Hydes, D.J., Wilson, T.R., 1984. Denitrification in a deep-sea sediment core from the eastern equatorial Atlantic. *Limnology and Oceanography* 29, 653-657.
- Suess, E., 1979. Mineral phases formed in anoxic sediments by microbial decomposition of organic matter. *Geochimica et Cosmochimica Acta* 43, 339-352.
- Suess, E., Müller, P.J., 1980. Productivity, sedimentation rate and sedimentary organic matter in the oceans: II. Elemental fractionation, *Proceedings of the CNRS Symposium on the Benthic Boundary Layer, Marseille, France*, 17–26.
- Sundby, B., Anderson, L.G., Hall, P.O.J., Iverfeldt, A., Rutgers van der Loeff, M.M., Westerlund, S.F.G., 1986. The effect of oxygen on release and uptake of cobalt, manganese, iron and phosphate at the sediment-water interface. *Geochimica et Cosmochimica Acta* 50, 1281-1288.
- Sundback, K., Miles, A., Hulth, S., Pihl, L., Engstrom, P., Selander, E., Svenson, A., 2003. Importance of benthic nutrient regeneration during initiation of macroalgal blooms in shallow bays. *Marine Ecology progress Series* 246, 115-126.
- Trimmer, M., Gowen, R.J., Stewart, B.M., Nedwell, D.B., 1999. The spring bloom and its impact on benthic mineralization rates in western Irish Sea sediments. *Marine Ecology Progress Series* 185, 37-46.
- Walsh, J.J., 1991. Importance of continental margins in the marine biogeochemical cycling of carbon and nitrogen. *Nature* 350, 53-55.

## Figure Captions

- Fig. 1. Map of the study area. Circle mark denotes the site where chamber was deployed.
- Fig. 2. Schematic diagram of the benthic chamber.
- Fig. 3. Tidal rhythm during the sampling periods. (Courtesy: *Indian Tide Tables 2004, Surveyor general of India, Government of India*). ■ marks on the X-axis denote the sampling time.
- Fig. 4. Variation of oxygen and nutrients with time inside the chamber in February.
- Fig. 5. Variation of oxygen and nutrients with time inside the chamber in March.
- Fig. 6. Variation of oxygen and nutrients with time inside the chamber in April.
- Fig. 7. Variation of oxygen and nutrients inside the chamber with time in August.
- Fig. 8. Correlation of benthic fluxes with concentration in water column and temperature
- Fig. 9. Spatial variation in benthic exchange rates. ○ marks represent the values at regular deployment site and ● marks for the values at a site ~5m away.
- Fig. 10. Seasonal changes in the pore water profiles in the Estuary.

Table 1.

Diffusive fluxes and *in-situ* fluxes in the Estuary. Diffusive fluxes were calculated from pore water concentration gradient and *in-situ* flux measured directly by benthic chamber incubation. All fluxes are expressed in  $\text{mmol m}^{-2} \text{d}^{-1}$ .

	February		March		April		August	
	Diffusive	<i>In-situ</i>	Diffusive	<i>In-situ</i>	Diffusive	<i>In-situ</i>	Diffusive	<i>In-situ</i>
$\text{NO}_3^-$	---- <sup>a</sup>	0.06	-0.002	-0.037	-0.007	-0.104	-0.05	-1.267
$\text{NH}_4^+$	---- <sup>a</sup>	2.77	2.008	5.159	2.581	4.002	0.386	0.839
DIN	---- <sup>a</sup>	3.086	---- <sup>b</sup>	5.096	---- <sup>b</sup>	3.927	---- <sup>b</sup>	-0.229
$\text{PO}_4^{3-}$	---- <sup>a</sup>	0.128	0.016	0.13	0.018	0.127	0.163	0.254
$\text{SiO}_4^{4-}$	---- <sup>a</sup>	4.605	1.221	5.78	0.167	3.116	0.26	0.415

<sup>a</sup> Porewater profile could not be obtained. <sup>b</sup> flux could not be calculated.

Table 2.

Stoichiometric ratios of  $\text{NH}_4^+ : \text{PO}_4^{3-} : \text{SiO}_4^{4-}$  in calculated diffusive fluxes and *in-situ* benthic fluxes in the Estuary.

Month	Diffusive	<i>In-situ</i>
Feb	----- <sup>a</sup>	21 : 1 : 35
March	125 : 1 : 76	39 : 1 : 44
April	143 : 1 : 9	31 : 1 : 24
August	2.3 : 1 : 1.5	3.3 : 1 : 1.6

<sup>a</sup> pore water nutrient data could not be obtained.

*Table 3.*

Seasonal variation in granulometric composition of the estuarine sediment.

Month	Sand (%)	Silt (%)	Clay (%)
March	68.39	26.01	5.6
August	34.68	44.12	21.2

*Table 4.*

Benthic turnover time and Percent contribution of benthic fluxes to primary production in Mandovi Estuary in different seasons.

Month	Integrated PP* (mmol C m <sup>-2</sup> d <sup>-1</sup> )	Turnover time (day)			% contribution of Benthic flux		
		DIN	DIP	SiO <sub>4</sub> <sup>4-</sup>	DIN	DIP	SiO <sub>4</sub> <sup>4-</sup>
Feb	75.0	5.7	20.8	16.7	27.26	18.15	40.68
Mar	188.2	4.2	15.7	10.1	17.94	7.30	20.35
Apr	99.0	8.4	37.6	10.4	26.28	13.55	20.85
Aug	31.0	--- <sup>a</sup>	5.9	864.4	17.95	81.19	8.88

\* Data from Pradeep Ram et al., (2003)

<sup>a</sup> could not be calculated since DIN flux was negative in August.



*Table 5.*

Percent contribution of average benthic flux to Gross Primary Productivity (GPP) and Net Ecosystem Productivity (NEP) in the Mandovi Estuary during premonsoon.

	Average flux (mmol m <sup>-2</sup> d <sup>-1</sup> )	Demand in for NEP (mmol m <sup>-2</sup> d <sup>-1</sup> )	Contribution of Benthic flux to NEP (%)	Demand in GPP (mmol m <sup>-2</sup> d <sup>-1</sup> )	Contribution of Benthic flux to GPP (%)
DIN	4.036	8.15	49.52	16.96	23.7
PO <sub>4</sub> <sup>3-</sup>	0.128	0.50	25.16	1.06	12.0
SiO <sub>4</sub> <sup>4-</sup>	4.50	8.15	55.21	16.96	26.5

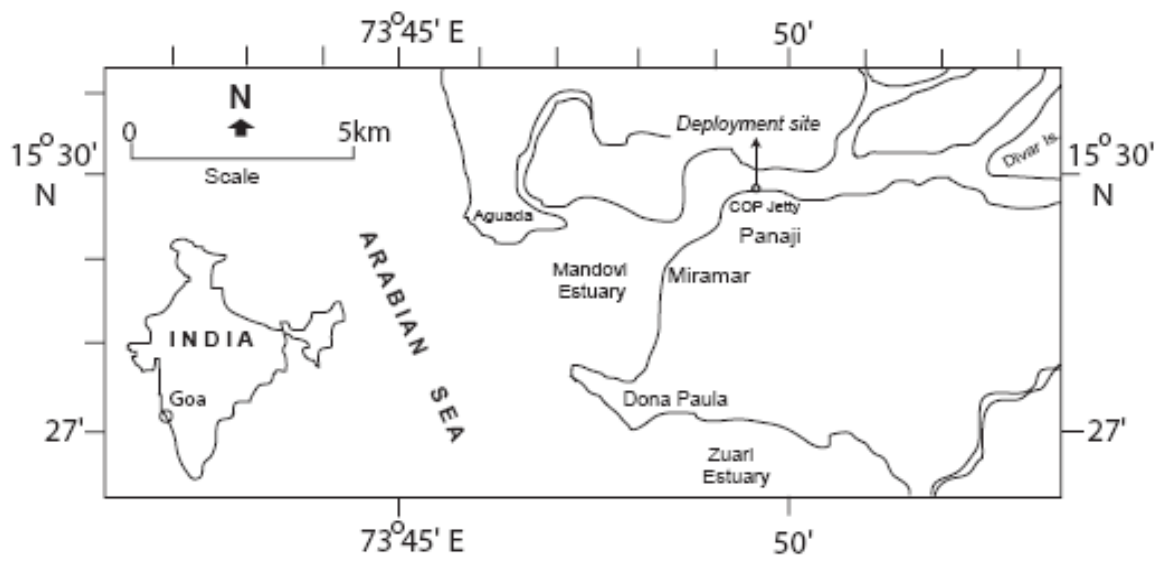

Fig. 1.

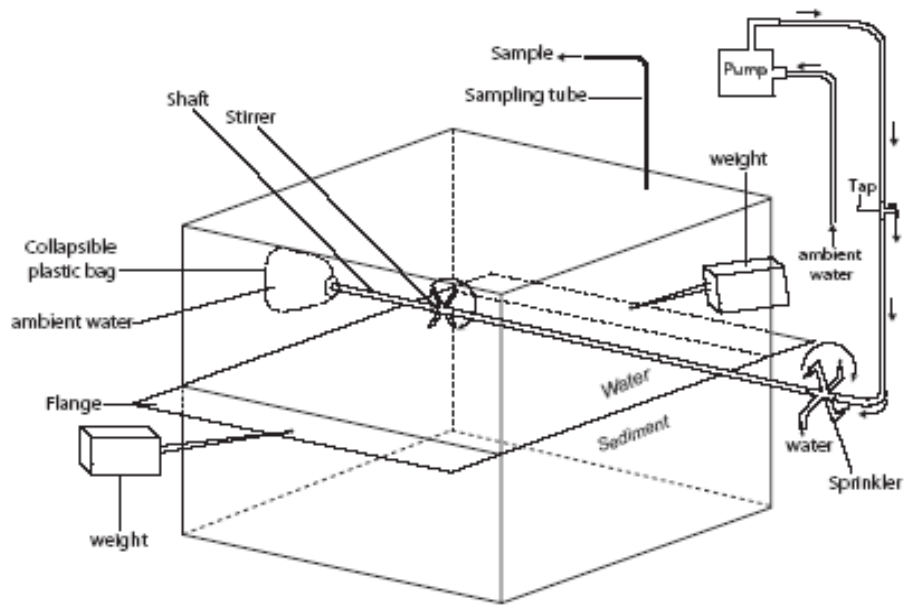

Fig. 2.

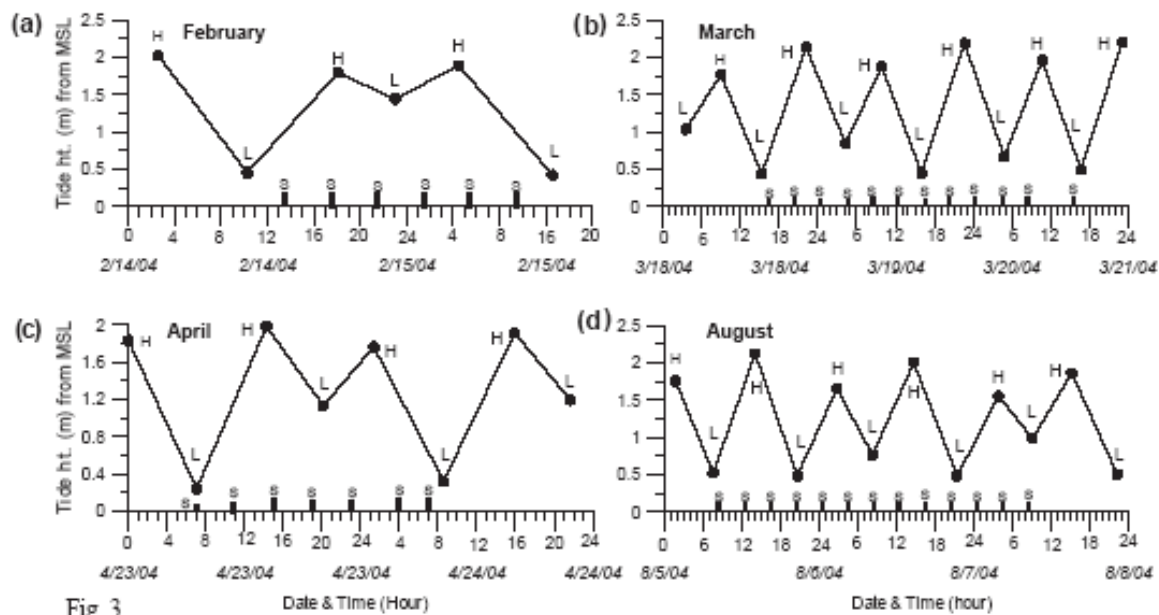

Fig. 3.

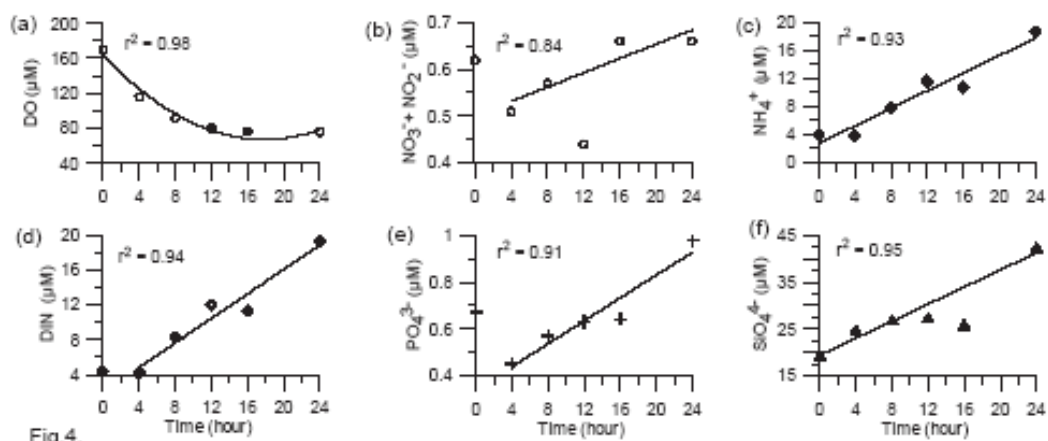

Fig.4.

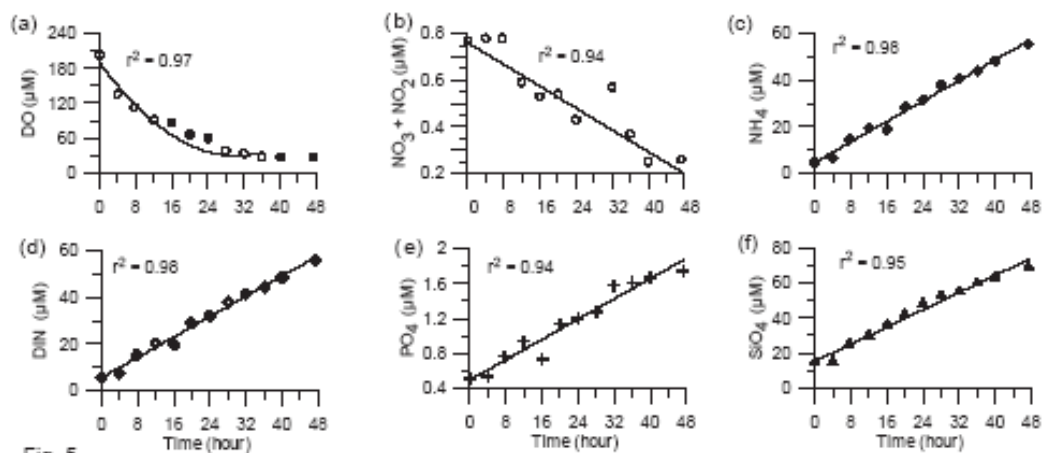

Fig. 5.

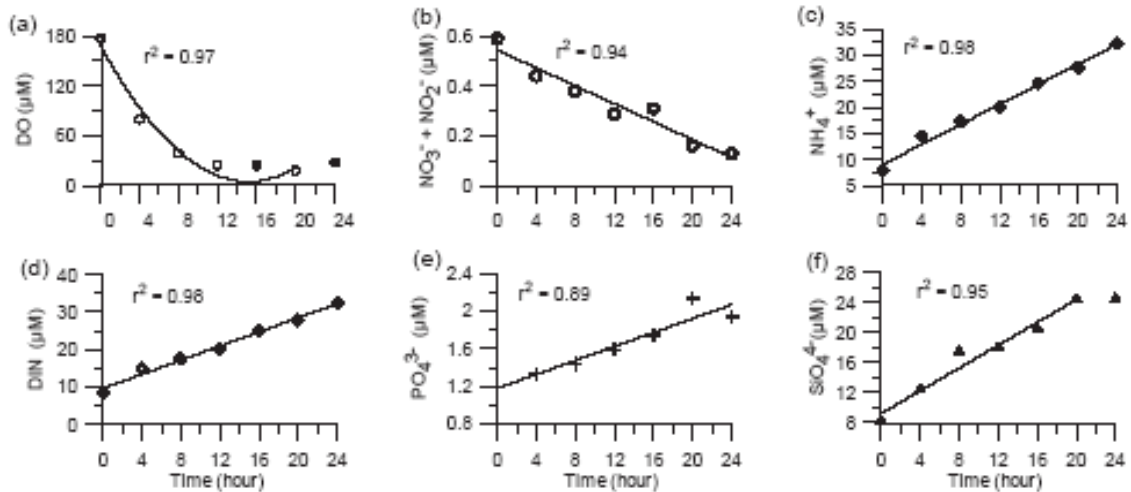

Fig. 6.

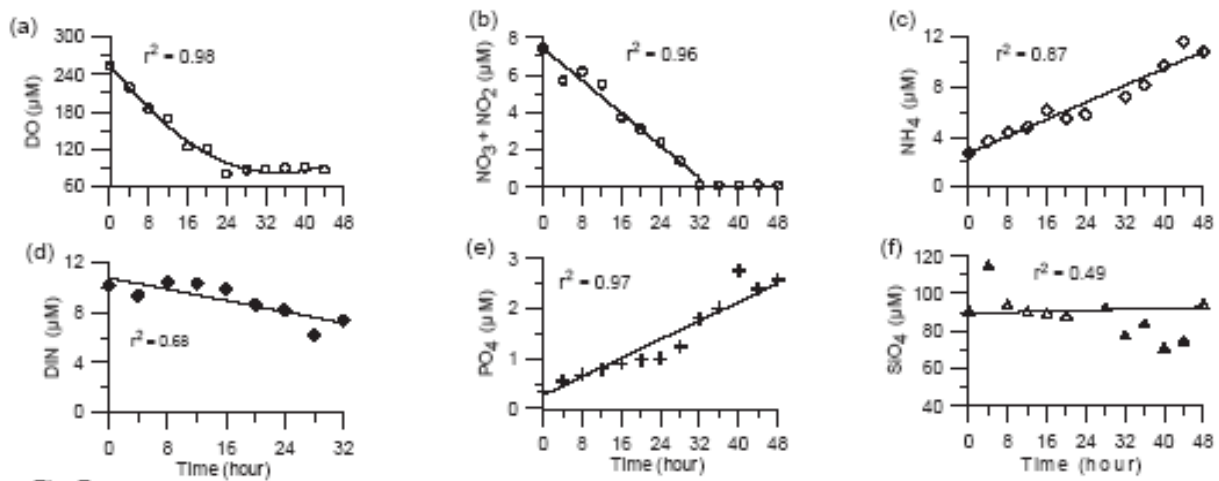

Fig. 7.

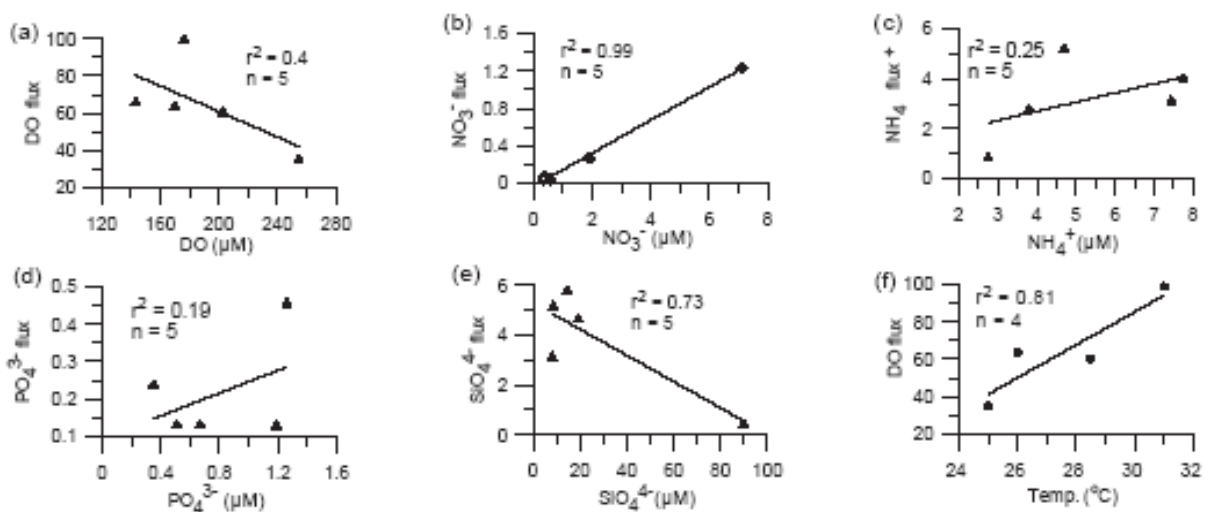

Fig. 8.

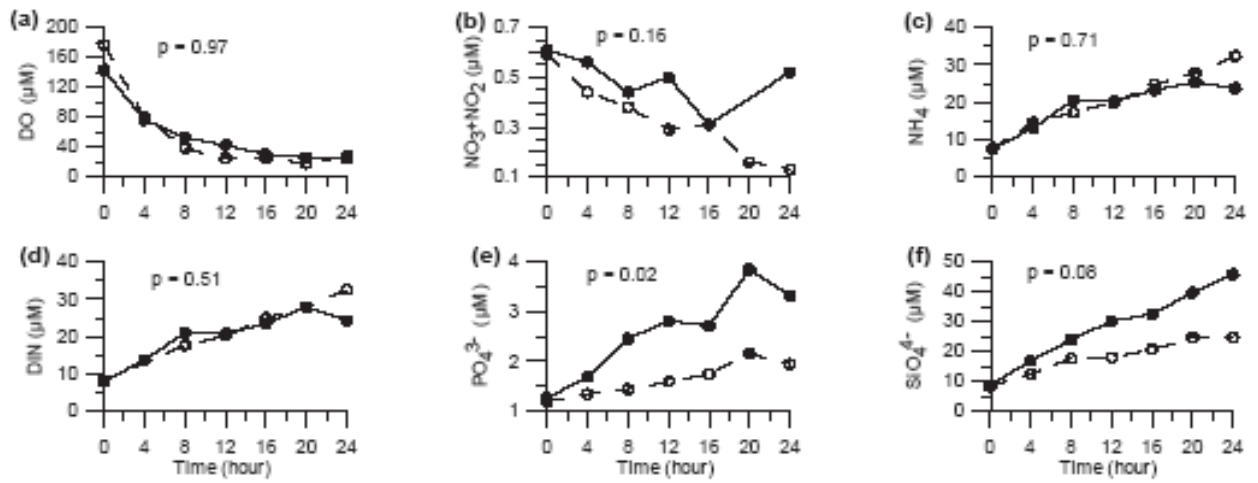

Fig. 9.

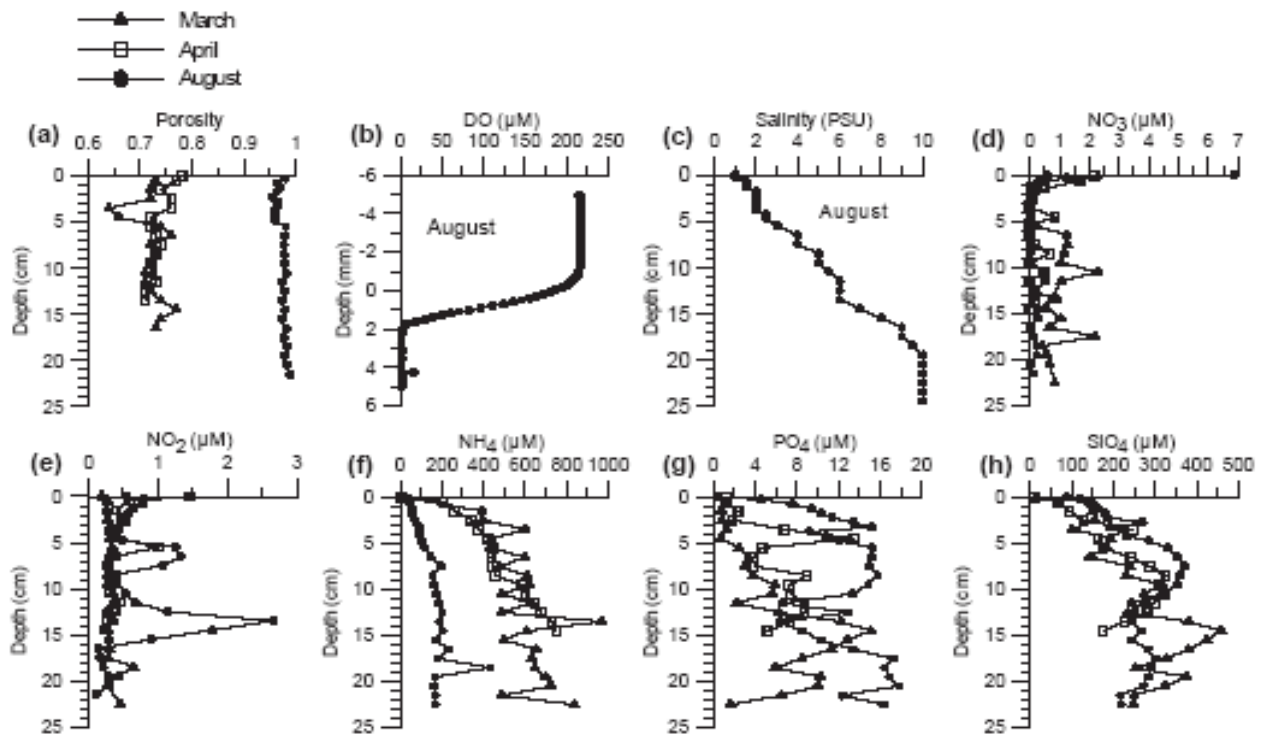

Fig. 10.