

Author version: *Syst. Appl. Microbiol.*, vol.34; 2011; 487–493

***Vibrio plantisponsor* sp. nov., a diazotrophic bacterium isolated from a mangrove associated wild rice (*Porteresia coarctata* Tateoka)**

N. Rameshkumar^{1, 2}, B. Gomez-Gil³, Cathrin Spröer⁴, Elke Lang⁴, N. Dinesh Kumar⁵, S. Krishnamurthi⁶, Sudha Nair¹ and A. Roque⁷

¹Microbiology Department, M. S. Swaminathan Research Foundation, 3rd Cross Street, Taramani Institutional Area. Chennai-600 113, INDIA

²Microbial Culture Collection, National Centre for Cell Science, Pune University Campus, Ganeshkhind, Pune- 411 007, India

³CIAD, A.C. Mazatlan Unit for Aquaculture and Environmental Management. AP 711, Mazatlan, Sinaloa. Mexico 82000

⁴DSMZ – Deutsche Sammlung von Mikroorganismen und Zellkulturen GmbH, Inhoffenstraße 7b, 38124 Braunschweig, Germany

⁵Aquatic Animal Health and Environmental Division, Central Institute of Brackishwater Aquaculture, Chennai, India , Pincode - 600 028

⁶National Institute of Oceanography, Dona Paula, Goa-403004

⁷Institut de Recerca i Tecnologia Agroalimentaries, Centre d'Aquicultura, AP 200 Sant Carles de la Rapita 43540, Spain

***Correspondence:**

N. Rameshkumar, Microbial Culture Collection, National Centre for Cell Science, Pune University Campus, Ganeshkhind, Pune- 411 007, India.

E-mail: rammicro@gmail.com

Running title: *Vibrio plantisponsor* sp.nov.

Keywords: mangrove, diazotroph, MLSA, *Vibrio*, rhizosphere

The GeneBank/EMBL/DDBJ accession numbers for the 16S rRNA, *recA*, *pyrH*, *nifH*, *gyrB*, *gapA* and *mreB*, gene sequences of strain MSSRF60^T and MSSRF64 are GQ352641, HM640395, HM640386, HM640387, HM640391, HM640392, HM640393, HM640394, GQ352644, HQ285761, HQ285762, HQ285764 and HQ285765. The GeneBank/EMBL/DDBJ accession numbers for *Vibrio areninigræ* J74^T HM640388 (*recA*), HM640389 (*gyrB*), HM640390 (*pyrH*) and HQ285763 (*gapA*).

Abstract

Two Gram negative, facultatively anaerobic, halophilic, motile, slightly curved rod-shaped bacterial strains MSSRF60^T and MSSRF64 were isolated from the roots of a mangrove-associated wild rice collected in the Pichavaram mangroves, India. These strains possess the key functional nitrogenase gene *nifH*. Phylogenetic analysis based on the 16S rRNA, *recA*, *gapA*, *mreB*, *gyrB* and *pyrH*, gene sequences revealed that strains MSSRF60^T and MSSRF64 belong to the genus *Vibrio*, and had the highest sequence similarity with the type strains of *Vibrio diazotrophicus* 7893^T (99.7, 94.8, 98.5, 97.9, 94.0 and 90.7%, respectively), *V. areninigræ* J74^T (98.2, 87.5, 91.5, 88.9, 86.5 and 84.6% respectively) and *V. hispanicus* LMG 13240^T (97.8, 87.1, 91.7, 89.8, 84.1 and 81.9%, respectively). The fatty acid composition too confirmed the affiliation of strains MSSRF60^T and MSSRF64 to the genus *Vibrio*. Several phenotypic traits were able to differentiate these strains from the closely related *Vibrio* species. The DNA G+C content of strain MSSRF60^T was 41.8 mol%. Based on phenotypic, genotypic (MLSA), ΔT_m , genomic fingerprinting (BOX-PCR) and DNA-DNA hybridisation analyses, strains MSSRF60^T and MSSRF64 represent a novel species of the genus *Vibrio*, for which the name *Vibrio plantiponsor* sp. nov. is proposed. The type strain is MSSRF60^T (=DSM 21026^T=LMG 24470^T=CAIM 1392^T).

Introduction

The family *Vibrionaceae* consists of a large number of ecologically diverse species [16], distributed into six genera *Vibrio* [8], *Photobacterium* [7], *Salinivibrio* [30], *Grimontia* [44], *Enterovibrio* [43] and *Aliivibrio* [51]. Currently, the genus *Vibrio* contains more than 80 described species (www.vibriobiology.net); most of these species were distributed into thirteen phylogenetic robust clades; namely Anguillarum, Cholerae, Coralliilyticus, Diazotrophicus, Gazogenes, Halioticoli, Harveyi, Nereis, Nigripulchritudo, Orientalis, Scopthalmi, Splendidus and Vulnificus based on the multilocus sequence analysis of nine genes (i.e., *ftsZ*, *gapA*, *gyrB*, *mreB*, *pyrH*, *recA*, *rpoA*, *topA*, and 16S rRNA) [40]. This genus includes type strains from various marine environments including seawater and marine sediments and from various organisms ranging from plankton to fish where they act as facultative symbionts, parasites or as pathogens [49]. But very few strains were described from plant rhizospheres even though, many studies have shown the recovery of *Vibrio* strains from various plant rhizospheres using culture-dependent and -independent methods [3,4,28,32], namely *Vibrio rhizosphaerae* MSSRF3^T [33], *V. porteresiae* MSSRF30^T [36] and *V. mangrovi* MSSRF38^T [34]. *V. diazotrophicus* and *V. hispanicus* are members of the diazotrophicus clade [40] with the recent addition of *V. areninigræ* [11]. Among

this clade, only *V. diazotrophicus* has been shown to have diazotrophic activity; it was isolated from the gastrointestinal tract of sea urchins [21]. The two other species were isolated from black sand, from *Artemia* sp., and from sea water, but none had been shown to have diazotrophic activity. The species which are capable to fix nitrogen are *V. diazotrophicus* [21], *V. porteresiae* MSSRF30^T [36], and *V. mangrovi* MSSRF38^T [34]. Reports from environmental *Vibrio* strains namely, *V. natriegens*, *V. pelagius*, and *V. cincinnatiensis* [52], *V. anguillarum*, and *V. campbellii* [22], and *V. parahaemolyticus* [13] have also shown to fix nitrogen. During the course of our studies on diazotrophic bacteria from mangrove-associated wild rice collected in Pichavaram, India, we found that two isolates MSSRF60^T, MSSRF64 constitute a novel species; this paper describes *Vibrio plantisponsor* sp. nov.

Materials and methods

Isolation and bacterial strains

Bacterial strains MSSRF60^T and MSSRF64 were isolated, as described earlier [35] from roots of mangrove-associated wild rice (*Porteresia coarctata* Tateoka), Pichavaram mangroves, Tamil Nadu., India. Bacteria (strains MSSRF60^T, MSSRF64, *V. diazotrophicus* CAIM 613^T (=DSM 2604^T), *V. hispanicus* CAIM 525^T (=DSM 16580^T) and *V. areninigræ* CAIM 1411^T (=DSM 22054^T) were maintained on ZoBell marine agar (HiMedia, India) at 4 °C and was stored at -80 °C in ZoBell marine broth (Himedia, India) containing 20 % (v/v) glycerol.

Phenotypic characterization

Isolates MSSRF60^T and MSSRF64 were observed under a phase-contrast microscope after 48 h growth in ZoBell marine broth at 28 °C to check for cell shape and motility. Gram staining was performed using the Gram staining kit (Himedia, India). Phenotypic characterization was performed using commercial miniaturized kits (API 50CH and API 20E; bioMérieux) and HiCarbohydrate kit (Himedia, India). The results were read after 24 and 48 h incubation at 28 °C, respectively. All suspension media for API test strips were supplemented to achieve a final concentration of 2.5 % NaCl, and for the HiCarbohydrate kit, to achieve 1.5 % (w/v) NaCl. Nutritional screening on multi-inoculated basal medium plates was performed by using previously described methods [29]. Growth at different NaCl concentrations [0 to 10 % (w/v)] was determined on 1 % tryptone broth [36]. Catalase activity was determined by bubble formation in a 3 % H₂O₂ solution. Oxidase activity was determined by using cytochrome oxidase paper (Himedia, India). The temperature range (10, 20, 37, 40 and 42 °C) for growth was determined by incubating the isolates on ZoBell marine broth for a week. To test the ability to grow in TCBS,

strain MSSRF60^T and MSSRF64 were tested for growth on thiosulphate/citrate/bile salts/sucrose agar (TCBS; Merck) plates by incubating them 48 h at 28 °C. Resistance to the vibriostatic agents O/129 (10 and 150 µg; Oxoid) was tested on ZoBell Marine agar medium by incubating at 48 h at 28 °C. *V. diazotrophicus* CAIM 613^T, *V. hispanicus* CAIM 525^T and *V. areninigræ* CAIM 1411^T used as reference strains in all above tests. For analysis of fatty acids, cells were grown on Marine Agar. After incubation for 1 day at 28°C, whole cell fatty acid methyl esters (FAMES) were obtained by methods previously described (24) and separated by a gas chromatograph (model 5898A, Hewlett Packard). Peaks were automatically integrated and fatty acid names and percentages were determined using the Microbial Identification standard software package MIDI (38).

Phylogeny

Genomic DNA was extracted from isolates MSSRF60^T, MSSRF64 and *V. areninigræ* J74^T as described [2]. PCR amplification and sequencing of the 16S rRNA, *gapA*, *mreB*, *recA*, *gyrB*, *pyrH* gene fragments were done as described previously [36,40]. The sequences of these genes were compared against the sequences available from GenBank using the BLASTN program [1] and the EzTaxon database [12]. The levels of 16S rRNA gene sequence similarity were determined by using the EzTaxon server (<http://www.eztaxon.org/>; 12). The sequences of these genes were compared against the sequences available from GenBank using the BLASTN program [1] and were aligned using CLUSTAL W software [48]. The concatenated sequences represented more than 90 % of the coding region for *gapA*, *mreB*, *recA*, *gyrB*, and *pyrH* genes, respectively. Distances were calculated according to Kimura's two-parameter correction [25]. Phylogenetic trees were inferred using the neighbour-joining [37] and maximum-parsimony [17] methods. Bootstrap analysis was based on 1000 resamplings. The MEGA3 package [26] was used for all analyses.

***nifH* amplification and sequencing**

nifH amplification was done as described previously [32,36]. For sequencing, the amplified DNA was separated on a 1% agarose gel, and a single *nifH* amplicon was purified using Eppendorf Perfectprep Gel Cleanup Kit (according to the manufacturer's instructions). The purified *nifH* amplicon was used directly for DNA sequencing with the dideoxy chain termination method with the BigDye terminator kit (Applied Biosystems) using the above mentioned *nifH* primers, and the reaction products were analysed by capillary electrophoresis on an ABI 310 Genetic Analyzer (Applied Biosystems). For phylogenetic analysis, partial *nifH* nucleotide sequences were aligned,

and a neighbour-joining phylogeny was constructed in the MEGA3 version using pairwise deletion of gaps and missing data and Kimura's two-parameter correction [25].

DNA-DNA hybridization and DNA base composition

DNA-DNA hybridization studies were carried out following two protocols with strains MSSRF60^T, MSSRF64 and its phylogenetically most closely related neighbours as revealed by 16S rRNA analysis; 1) DNA-DNA hybridization studies were performed as described by [14] under consideration of the modifications described [23] using a model Cary 100 Bio UV/VIS-spectrophotometer equipped with a Peltier-thermostatted 6x6 multicell changer and a temperature controller with *in-situ* temperature probe (Varian). For hybridization analysis, cells were disrupted using a French pressure cell (Thermo Spectronic), and the DNA in the crude lysate was purified by chromatography on hydroxyapatite as described [10]. 2) The DNA-DNA relatedness was measured by the difference in ΔT_m of the type strain and the hybrid of the proposed new species strain and the type strain, also by thermal denaturation temperatures [20]. Hybridizations between MSSRF60^T=CAIM 1392^T and CAIM 525^T (*V. hispanicus*), CAIM 1392^T and CAIM 613^T (*V. diazotrophicus*), CAIM 1392^T and CAIM 1411^T (*V. areninigrae*), and CAIM 525^T and CAIM 1411^T were done in 0.1 $\mu\text{g } \mu\text{l}^{-1}$ SSC (67.5 μl final volume) at 60 °C with a final DNA concentration of 45 $\text{ng } \mu\text{l}^{-1}$ of each strain (heterologous hybrids). For the homologous hybrids, only the type strains were used at a final DNA concentration of 90 $\text{ng } \mu\text{l}^{-1}$. The hybridization protocol was 10 min at 99 °C, then 8 h at 60 °C, followed by succession of steps each for 1 h at 10 °C below the previous temperature until 25 °C was reached. The samples were kept at 4 °C until the fluorimetric determination was done [20]. Prior to the fluorimetric evaluation, 7.5 μl of SYBR Green I (0.1 $\mu\text{l ml}^{-1}$ of 1X SSC) were added, mixed, and 25 μl dispensed in a 96-well microtiter plate by triplicate. The hybridization was done twice. The G+C mol% was determined by a fluorimetric method by thermal denaturation temperatures measured in quantitative PCR equipment (iCycler, ver. 3.0 from Bio-Rad) as proposed [20].

Genomic fingerprinting

Genomic fingerprinting was performed using BOX primer as described earlier [32]. *V. diazotrophicus* CAIM 613^T, *V. hispanicus* CAIM 525^T and *V. areninigrae* CAIM 1411^T were used as reference type strains.

Result and discussion

Phylogenetic analyses

Phylogenetic analysis based on 16S rRNA gene sequences revealed that strains MSSRF60^T and MSSRF64 belonged to the genus *Vibrio* and were phylogenetically close related to species of the Diazotrophicus clade [40] (Fig.1). The closest phylogenetic neighbours were *Vibrio diazotrophicus* LMG 7893^T (16S rRNA gene sequence similarity, 99.7 %), *V. areninigræ* J74^T (98.2 %), and *V. hispanicus* LMG 13240^T (97.8 %). No other type strain of the genus *Vibrio* showed sequence similarity values of more than 97.8 % to the 16S rRNA gene sequence. Both strains analysed share 100 % 16S rRNA gene sequence similarities among each other. The topology of the phylogenetic tree built using the maximum-parsimony algorithm was similar to those of the tree constructed with the neighbour-joining method (Fig. 1). These values are well above the cut-off value of 97 % for bacterial species definition [41], so other housekeeping genes proven useful for the differentiation of *Vibrio* and its related species [33,34,36,39,40] were analyzed.

For the present study, we used five housekeeping genes, *recA*, *gyrB*, *pyrH*, *mreB* and *gapA* in order to verify the taxonomic position of strains MSSRF60^T and MSSRF64. This analysis also supported the phylogenetic positioning of strains MSSRF60^T and MSSRF64 within the genus *Vibrio* and were most closely related to species of the Diazotrophicus clade with high bootstrap support values and revealed its distinct phylogenetic position (Supplementary Figs S1–S5). Strains MSSRF60^T and MSSRF64 shared 100 % sequence similarity among each other with five housekeeping genes analysed. Pairwise sequence similarities between MSSRF60^T and type strains of closest neighbours of Diazotrophicus clade ranged from 87.1 % to 94.8 % (*recA*), 84.1 % to 94.0 % (*gyrB*), 81.9 % to 90.7 % (*pyrH*), 88.9 % to 97.9 % (*mreB*) and 91.5 % to 98.5 % (*gapA*) (Table 1). These data corroborates with previous research that different genes show different degrees of discrimination according to the group of vibrios under analysis [47,49] and revealed that *recA*, *gyrB*, and *pyrH*, gene sequences has higher phylogenetic resolution then *mreB* and *gapA*, gene sequences, as it showed relatively lower gene similarities (< 95 %, < 95 %, and < 91 %) with its closest relatives (Table 1), as these similarity values were lower than the intraspecies variation in the genus *Vibrio* [33, 36, 40, 47], indicating a separate species status for strains MSSRF60^T and MSSRF64. A multigene phylogenetic tree was constructed for MSSRF60^T and MSSRF64 using these five genes (*recA*, *gyrB*, *pyrH*, *mreB* and *gapA*). This analysis also showed that the strains MSSRF60^T and MSSRF64 occupy a distinct phylogenetic position (Fig. 2), thus

reinforcing the conclusion that strains MSSRF60^T and MSSRF64 deserves the status of a separate and new species.

DNA-DNA hybridization and DNA base composition

The DNA-DNA hybridization (DDH) percentage was done in duplicate, with 92.0 % and 87.9 % between MSSRF60^T and MSSRF64, 67.3 % and 65.5 % between MSSRF60^T and *V. diazotrophicus* CAIM 613^T, 30.5 % and 28.3 % between MSSRF60^T and *V. hispanicus* CAIM 525^T, and 18.6 % and 17.3 % relatedness between MSSRF60^T and *V. areninigræ* CAIM 1411^T. These data showed that strains MSSRF60^T and MSSRF64 belong to same species and neither of them belongs to the other species of the Diazotrophic clade, as the values are well below the 70 % DNA-DNA similarity threshold for the definition of bacterial species by the *ad hoc* committee [53]. Previous reports have also shown a high DNA–DNA relatedness between different species of the *Vibrio* [6, 15]. For instance, strains of *Vibrio harveyi* and *Vibrio campbellii* have up to 74% DNA–DNA relatedness [46], >65% DNA-DNA relatedness between *V. rotiferianus* with *V. campbellii* and with *V. harveyi* [18], 66 % DNA-DNA relatedness between *V. fortis* with *V. pelagius* [45], *V. hepatarius* with *V. orientalis* [45] and *V. neptunius* with *V. coralliilyticus* [50], 67 % DNA-DNA relatedness between *V. mimicus* and *V. cholerae* [49]. Hence, we also performed the other method recommended [42] for species definition, the divergence between the thermal denaturation midpoint of homoduplex DNA and heteroduplex DNA (ΔT_m) as described [20] with strain MSSRF60^T. This result showed that the mean ΔT_m between strain MSSRF60^T (=CAIM 1392^T) and *V. hispanicus* CAIM 525^T was 11.9 °C (11.6-12.2 °C, Suppl. Fig. 6a), 11.15 °C (10.9-11.4 °C) between MSSRF60^T (=CAIM 1392^T) and *Vibrio diazotrophicus* CAIM 613^T (Suppl. Fig. 6b), 15.75 °C (15.2-16.3 °C) between MSSRF60^T (=CAIM 1392^T) and *V. areninigræ* CAIM 1411^T (Suppl. Fig. 6c), and 12.6 °C between *V. hispanicus* CAIM 525^T and *V. areninigræ* CAIM 1411^T, as positive control (Suppl. Fig. 6d). These values are well above the 5 °C established as a minimum to delineate a new species [53]. Thus, DNA-DNA relatedness and ΔT_m method clearly establishes the need for the proposal of strain MSSRF60^T as a novel species of *Vibrio* and this result is further supported from the multilocus sequence analysis of three genes (*recA*, *pyrH*, and *gyrB*), were it showed gene sequence similarities lower than 95 % with its closest type strains *Vibrio diazotrophicus* LMG 7893^T, *V. areninigræ* J74^T and *V. hispanicus* LMG 13240^T (table 1). This clearly proves the fact that *Vibrio* strains which have housekeeping gene similarities lower than 95 % (*recA*, *pyrH*, and *gyrB*) will have less than 70 % DNA-DNA similarity [33,34,36,40,47,49], indicating the advantage of multilocus sequence analysis as a good

substitute for DNA-DNA hybridization in describing new *Vibrio* species. The determination of the G+C content of strain MSSRF60^T resulted in 41.83 mol%, which was in good agreement with values for the genus *Vibrio* [5].

Genomic fingerprinting

The taxonomic relationship between the two novel isolates with its closest phylogenetic neighbours as indicated by 16S rRNA analysis was determined using BOX-PCR. This result showed that the two novel isolates (MSSRF60^T and MSSRF64) are identical in their banding pattern, indicating that they are belonging to same single species. Moreover they had distinct banding pattern that is different from its closest neighbours, having less than 55 % pattern similarity (Fig. 3), which indicates that these two isolates doesn't belong to any strains of Diazotrophicus clade and further supporting the results of DNA-DNA relatedness. As it has been previously shown that rep-PCR similarities around 65 % represent more than 70 % DNA-DNA similarity (31), adding to the advantage of using genomic fingerprinting as additional taxonomic data to prove whether the isolates are novel, especially to isolates where phenotypically the isolates are indistinguishable, as in case of *Vibrio* species (49).

Phenotypic characteristics

The isolates MSSRF60^T and MSSRF64 had the main phenotypic features of the genus *Vibrio*-straight to slightly curved rods, motile, facultative anaerobe, gram-negative, oxidase and catalase-positive. They grew on TCBS, were susceptible to the vibriostatic agent O/129 (150 mg per disc), no growth in the absence of NaCl was observed and stimulation of growth by NaCl. Morphological, cultural, physiological and biochemical characteristics of strain MSSRF60^T are given in the species description and its differentiating phenotypic characters from its phylogenetically related species were given in (Table 2). Variable reactions among the novel isolates were observed when using 1) API 20E strips; strain MSSRF60^T showed negative for arginine dihydrolase, Voges-Proskauer and positive for gelatinase were as strain MSSRF64 showed positive for arginine dihydrolase and Voges-Proskauer and negative for gelatinase. 2) Using method [29]; strain MSSRF60^T showed positive utilisation for L-histidine, D-melibiose, lactose and putrescine while weak utilisation for glycerol and L-rhamnose were as MSSRF64 showed weak utilisation for L-histidine, D-melibiose, lactose and putrescine while positive utilisation for glycerol and L-rhamnose. The whole cell fatty acids of the two novel strains (MSSRF60^T and MSSRF64) were dominated by the unsaturated compounds C_{16:1} ω7c and C_{18:1} ω7c and by hexadecan. One hydroxylated, namely C_{12:0}-3OH, and two branched, namely iso-C_{14:0} and iso-C_{16:0}, fatty acids were detected (Supplementary Table S1). The compounds present as well

as their proportion are in good accord with the patterns described earlier for *Vibrio* species (9, 27). Chang and coauthors (2008) found minor amounts of two other iso-branched compounds, iso-C_{16:0} and iso-C_{18:0}, in the type strain of *V. hispanicus*, a fact which might be due to the longer incubation time (3 d) before measurement which was applied by these authors. These additional components were absent in *V. areninigræ*. The fatty acid composition confirmed the affiliation of strains MSSRF60^T and MSSRF64 to the genus *Vibrio* but offered no means to differentiate them from their closest phylogenetic neighbours, stating the fact that fatty acid analysis can be used as an additional phenotypic character (9,27, 49).

Diazotrophy

Studies have shown that plant roots, rhizosphere are good sources for isolating nitrogen fixing strains from salt marsh ecosystems [3,4,28,32]. As the isolates MSSRF60^T, and MSSRF64 studied here are from plant roots, the strains were subjected to an *nifH* specific PCR amplification using the primers [32,36]; the expected 390-bp amplification product was observed in all strains (data not shown). The amplified 390-bp fragment of strain MSSRF60^T was then sequenced and it shared 97.4 % sequence similarity with *Vibrio diazotrophicus*, *V. porteresiae* (85.7 %), *V. parahaemolyticus* (85.5 %) and *V. natriegens* (84.7 %). However, similarities with the other *nifH* sequences from the NCBI database were 76.0–85.0 %. Phylogenetic analysis showed a clear affiliation of the MSSRF60^T *nifH* sequences with sequences from other N₂-fixing *Vibrio* species and clearly differentiated the MSSRF60^T *nifH* sequences from those of other N₂-fixing species (Fig. 4).

In conclusion, based on the results presented in this study, we propose to classify the two strains MSSRF60^T and MSSRF64 in the novel species *Vibrio plantisponsor*. The novel species can be differentiated from its phylogenetic neighbours by means of MLSA (*recA*, *pyrH* and *gyrB*), DNA-DNA relatedness, ΔT_m , genomic fingerprinting (BOX-PCR) and several phenotypic tests (table 2).

Description of *Vibrio plantisponsor* sp. nov.

(plan.ti.spon' sor. L. fem. n. planta, plant; L. masc. n. sponsor, sponsor, guarantor; N.L. masc. n. plantisponsor, sponsor of plants, referring to the potentially plant-beneficial properties of the type strain)

Cells are straight to slightly curved rods, motile, Gram-negative bacteria. Colonies on ZoBell marine agar are circular, smooth, opaque and usually 2–4 mm in diameter within two days at 28 °C. Grows in the presence of NaCl concentrations from 0.5 to 8 % (w/v), and optimally in the presence of 1 to 2.5 % (w/v) NaCl at 28 °C and no growth in absence of salt. Growth occurs at 10-40 °C (optimal growth occurs at 28 °C). The isolate grows on TCBS medium, producing yellow colonies. Oxidase- and catalase-positive. The DNA G+C content of the type strain is 41.8 mol%. Aerobic or facultatively anaerobic, mesophilic and halotolerant. Able to ferment carbohydrates. Negative for lysine decarboxylase, ornithine decarboxylase, H₂S production, urease, gelatinase, tryptophan deaminase, and Voges-Proskauer. Positive for arginine dihydrolase, citrate utilization, indole production and aesculin hydrolysis. The strain produces amylases, β -galactosidase and caseinase. Ferments xylose, maltose, fructose, dextrose, galactose, melibiose, sucrose, L-arabinose, mannose, ribose, cellobiose, D-arabinose and sorbose. Late acid production from galactose, raffinose, trehalose, sodium gluconate, glycerol, inositol, sorbitol, adonitol. No acid production from lactose, inulin, salicin, glucosamine, dulcitol, α -methyl-D-glucoside, rhamnose, melezitose, α -methyl-D-mannoside, xylitol, and malonate when using Hicarbohydrate kit. Utilisation as evident from API 50CH and API 20E strips; positive utilization for L-arabinose, D-ribose, D-xylose, D-galactose, D-glucose, D-fructose, D-mannose, L-rhamnose, D-mannitol, N-acetylglucosamine, arbutin, salicin, D-cellobiose, D-maltose, D-saccharose, D-trehalose, D-raffinose, amidon, glycogen, gentiobiose, and potassium gluconate. Delayed positive reaction D-lactose. Negative utilization of erythritol, D-arabinose, L-xylose, D-adonitol, methyl-betaD-xylopyranoside, L-sorbose, dulcitol, inositol, D-sorbitol, methyl-alphaD-mannopyranoside, methyl-alphaD-glucopyranoside, amygdalin, melibiose, inulin, D-melezitose, xylitol, D-turanose, D-lyxose, D-tagatose, D-fucose, L-fucose, D-arabitol, L-arabitol, potassium 2-ketogluconate, and potassium 5-ketogluconate. Shows sensitivity to the vibriostatic agent O/129. Utilisations as evident from method [29] positive utilisation for 2-ketoglutarate, acetate, D,L,lactate, D-cellobiose, D-fructose, D-galactose, D-galacturonate, D-glucose, D-glucuronate, D-mannitol, D-mannose, D-melibiose, D-trehalose, fumarate, glycerol (weak), lactose, L-alanine, L-arabinose, L-aspartate, L-glutamate, L-glutamine, L-histidine, L-leucine, L-ornithine, L-rhamnose (weak), L-threonine, maltose, N-acetyl-D-glucosamine, propionate, putrescine, pyruvate, succinate, sucrose, xylose and negative for p-hydroxybenzoate. The most abundant fatty acids are summed feature 3 (33.9 %; comprising C_{16:1} ω 7c), C_{16:0} (24.2 %), C_{18:1} ω 7c and C_{18:1} ω 6c (17.7 %), C_{14:0} (5.7 %), C_{12:0} (4.5 %), iso-C_{16:0} (2.4 %), summed feature 2 (3.3 %; comprising iso-C_{16:1} and C_{14:0}-3OH) and C_{12:0}-3OH (3.4 %). The following fatty acids are detected in small amounts; iso-C_{14:0} (0.6 %), C_{15:0} (0.4%), C_{17:1} ω 8c (0.3 %), C_{17:0} (0.2%), C_{18:0} (0.6 %), 11-methyl-C_{18:1} ω 7c (0.2 %), summed

feature 7 incl. C_{19:1} ω6c (0.5 %) and an unidentified fatty acid with an equivalent chain-length of 12.484 (0.7 %).

The type strain is MSSRF60^T (=DSM 21026^T=LMG 24470^T=CAIM 1392^T) and was isolated from roots of mangrove-associated wild rice (*Porteresia coarctata* Tateoka) and possess the *nifH* gene

Acknowledgements.

The authors, RK and SN thank the Department of Biotechnology (DBT), India for financial support. To Oswaldo Palenzuela (CSIC, Instituto de Acuicultura de Torre de la Sal, Spain) for use of the iCycler. Partial financing was done by the INIA project RTA-2008-00063, Spain. We would like to thank Bettina Sträubler for excellent technical assistance and G. Poetter for competent performance of the fatty acid analyses.

References

- [1] S.F. Altschul, W.Gish, W. Miller, E.W. Myers, D.J. Lipman, Basic local alignment search tool, *J. Mol. Biol.* 215 (1990) 403–410.
- [2] F.M. Ausubel, R. Brent, R. E. Kingston, D.D. Moore, J.G. Seidman, J.A. Smith, K. Struhl, *Current Protocols in Molecular Biology*, (1987) New York: Wiley.
- [3] C.E. Bagwell, C.R. Lovell, Microdiversity of culturable diazotrophs from the rhizoplanes of the salt marsh grasses *Spartina alterniflora* and *Juncus roemerianus*, *Microb. Ecol.* 39 (2000) 128–136.
- [4] C.E. Bagwell, Y.M Piceno, A. Ashburne-Lucas, C.R. Lovell, Physiological diversity of the rhizosphere diazotroph assemblages of selected salt marsh grasses, *Appl. Environ. Microbiol.* 64 (1998) 4276–4282.
- [5] P. Baumann, A.L. Furniss, J.V. Lee, Genus I. *Vibrio* Pacini 1854, 411. In *Bergey's Manual of Systematic Bacteriology*, vol. 1, (1984) pp. 518–538. Edited by N. R. Krieg & J. G. Holt. Baltimore: Williams & Wilkins.
- [6] P. Baumann, L. Baumann, Biology of the marine enterobacteria: genera *Beneckea* and *Photobacterium*, *Annu. Rev. Microbiol.* 31 (1977) 39–61.
- [7] P. Baumann, L. Baumann, Genus II. *Photobacterium* Beijerinck 1889, 401AL. In *Bergey's Manual of Systematic Bacteriology*, vol. 1, pp. 539–545. Edited by N. R. Krieg & J. G. Holt. Baltimore, MD: Williams & Wilkins. (1984).

- [8] P. Baumann, R.H.W. Schubert, Family II. *Vibrionaceae* Veron 1965, 5245AL. In *Bergey's Manual of Systematic Bacteriology*, vol. 1, pp. 516–517. Edited by N. R. Krieg & J. G. Holt. Baltimore, MD: Williams & Wilkins. (1984).
- [9] S. Bertone, M. Giacomini, C. Ruggiero, C. Piccarolo, L. Calegari, Automated systems for identification of heterotrophic marine bacteria on the basis of their fatty acid composition, *Appl. Environ. Microbiol.* 62 (1996) 2122-2132.
- [10] P. Cashion, M.A. Hodler-Franklin, J. McCully, M. Franklin, A rapid method for base ratio determination of bacterial DNA, *Anal. Biochem.* 81 (1977) 461–466.
- [11] H.W. Chang, S.W. Roh, K.H. Kim, Y.D. Nam, C.O. Jeon, H.M. Oh, J.W. Bae, *Vibrio areninigræ* sp. nov., a marine bacterium isolated from black sand, *Int. J. Syst. Evol. Microbiol.* 58 (2008) 1903-1906.
- [12] J. Chun, J.H. Lee, Y. Jung, M. Kim, S. Kim, B.K. Kim, Y.W. Lim, EzTaxon: a web-based tool for the identification of prokaryotes based on 16S ribosomal RNA gene sequences, *Int. J. Syst. Evol. Microbiol.* 57 (2007) 2259–2261.
- [13] J.D. Criminger, T.H. Hazen, P.A. Sobecky, C.R. Lovell, Nitrogen fixation by *Vibrio parahaemolyticus* and its implications for a new ecological niche, *Appl. Environ. Microbiol.* 73 (2007) 5959–5961.
- [14] J. De Ley, H. Cattoir, A. Reynaerts, The quantitative measurement of DNA hybridization from renaturation rates, *Eur. J. Biochem.* 12(1970)133–142.
- [15] M. Dorsch, D. Lane, E. Stackebrandt, Towards a phylogeny of the genus *Vibrio* based on 16S rRNA sequences, *Int. J. Syst. Bacteriol.* 42 (1992) 58–63.
- [16] J.J. (III) Farmer, J.M. Janda, F.W. Brenner, D.N. Cameron, K.M. Birkhead, Genus I. *Vibrio Pacini* 1854, 411AL. In *Bergey's Manual of Systematic Bacteriology*, 2nd edn, vol. 2 part B, pp. 494–546. Edited by D. J. Brenner, N. R. Krieg & J. T. Staley. New York: Springer. (2005).
- [17] W.M. Fitch, Toward defining the course of evolution: minimum change for a specific tree topology, *Syst. Zool.* 20 (1971) 406–416.
- [18] B. Gomez-Gil, F. L. Thompson, C. C. Thompson, J. Swings, *Vibrio rotiferianus* sp. nov., isolated from cultures of the rotifer *Brachionus plicatilis*, *Int. J. Syst. Evol. Microbiol.* 53 (2003) 239-243.
- [19] J.M. Gonzalez, C. Saiz-Jimenez, A fluorimetric method for the estimation of G+C mol% content in microorganisms by thermal denaturation temperature, *Environ. Microbiol.* 4 (2002) 770-773.
- [20] J.M. Gonzalez, C. Saiz-Jimenez, A simple fluorimetric method for the estimation of DNA-DNA relatedness between closely related microorganisms by thermal denaturation temperatures, *Extremophiles.* 9 (2005) 75-79.
- [21] M.L. Guerinot, P.A. West, J.V. Lee, R.R. Colwell, *Vibrio diazotrophicus* sp. nov., a marine nitrogen-fixing bacterium, *Int. J. Syst. Bacteriol.* 32 (1982) 350–357.

- [22] G. Holguin, M.A. Guzman, Y. Bashan, Two new nitrogen fixing bacteria from the rhizosphere of mangrove trees: their isolation, identification and in vitro interaction with rhizosphere *Staphylococcus* sp, FEMS. Microbiol. Ecol. 101 (1992) 201–216.
- [23] V.A.R. Huß, H. Festl, K.H. Schleifer, Studies on the spectrophotometric determination of DNA hybridization from renaturation rates, Syst. Appl. Microbiol. 4 (1983) 184–192.
- [24] P. Kämpfer, R. M. Kroppenstedt, Numerical analysis of fatty acid patterns of coryneform bacteria and related taxa, Can. J. Microbiol. 42 (1996) 989-1005.
- [25] M. Kimura, A simple method for estimating evolutionary rates of base substitutions through comparative studies of nucleotide sequences, J. Mol. Evol. 16 (1980) 111–120.
- [26] S. Kumar, K. Tamura, M. Nei, MEGA3: integrated software for molecular evolutionary genetics analysis and sequence alignment, Brief. Bioinform. 5 (2004) 150–163.
- [27] M.A. Lambert, F. W. Hickman-Brenner, J. J. Farmer III, W. Moss, Differentiation of *Vibrionaceae* species by their cellular fatty acid composition, Int. J. Syst. Bacteriol. 33 (1983) 777-792.
- [28] J.R. LaRocque, P.W. Bergholz, C.E. Bagwell, C.R. Lovell, Influence of host plant-derived and abiotic environmental parameters on the composition of the diazotroph assemblage associated with roots of *Juncus roemerianus*, Antonie. Van. Leeuwenhoek. 86 (2004) 249–261.
- [29] M.C. Macian, W. Ludwig, R. Aznar, P.A.D. Grimont, K.H. Schleifer, E. Garay, M.J. Pujalte, *Vibrio lentus* sp. nov., isolated from Mediterranean oysters, Int. J. Syst. Evol. Microbiol. 51 (2001) 1449–1456.
- [30] E. Mellado, E.R.B. Moore, J.J. Nieto, A. Ventosa, Analysis of 16S rRNA gene sequences of *Vibrio costicola* strains: description of *Salinivibrio costicola* gen. nov., comb. nov, Int. J. Syst. Bacteriol. 46 (1996) 817–821.
- [31] J.L.W. Rademaker, B. Hoste, F.J. Louws, K. Kersters, J. Swings, L. Vauterin, P. Vauterin, F.J. de Bruijn, Comparison of AFLP and rep-PCR genomic fingerprinting with DNA–DNA homology studies: *Xanthomonas* as a model system, Int. J. Syst. Evol. Microbiol. 50 (2000) 665-677.
- [32] N. Ramesh kumar, S. Nair, Isolation and molecular characterization of genetically diverse antagonistic, diazotrophic red-pigmented vibrios from different mangrove rhizospheres, FEMS. Microbiol. Ecol. 67 (2009) 455–467.
- [33] N. Ramesh kumar, S. Nair, *Vibrio rhizosphaerae* sp. nov., a novel red-pigmented species that antagonizes Phytopathogenic Bacteria, Int. J. Syst. Evol. Microbiol. 57 (2007) 2241–2246.
- [34] N. Rameshkumar, C. Sproer, E. Lang, S. Nair, *Vibrio mangrovi* sp. nov., a diazotrophic bacterium isolated from mangrove-associated wild rice (*Porteresia coarctata* Tateoka), FEMS. Microbiol.Lett. 307 (2010) 35-40.

- [35] N. Rameshkumar, E. Lang, S. Nair, *Mangrovibacter plantisponsor* gen. nov., sp. nov., a nitrogen-fixing bacterium isolated from a mangrove-associated wild rice (*Porteresia coarctata* Tateoka), *Int. J. Syst. Evol. Microbiol.* 60 (2010) 179-186.
- [36] N. Rameshkumar, Y. Fukui, T. Sawabe, S. Nair, *Vibrio porteresiae* sp. nov., a novel diazotrophic bacterium isolated from a mangrove associated wild rice (*Porteresia coarctata* Tateoka), *Int. J. Syst. Evol. Microbiol.* 58 (2008) 1608-1615.
- [37] N. Saitou, M. Nei, The neighbor-joining method: a new method for reconstructing phylogenetic trees, *Mol. Biol. Evol.* 4 (1987) 406-425.
- [38] M. Sasser, Identification of bacteria by gas chromatography of cellular fatty acids, *USFCC Newsl.* 20 (1990) 16.
- [39] T. Sawabe, K. Hayashi, J. Moriwaki, Y. Fukui, F.L. Thompson, J. Swings, R. Christen, *Vibrio neonatus* sp. nov. and *Vibrio ezuriae* sp. nov. isolated from the gut of Japanese abalones, *Syst. Appl. Microbiol.* 27 (2004) 527-534.
- [40] T. Sawabe, K. Kita-Tsukamoto, F.L. Thompson, Inferring the evolutionary history of vibrios by means of multilocus sequence analysis, *J. Bacteriol.* 189 (2007) 7932-7936.
- [41] E. Stackebrandt, B.M Goebel, Taxonomic note: a place for DNA-DNA reassociation and 16S rRNA sequence analysis in the present species definition in bacteriology, *Int. J. Syst. Bacteriol.* 44 (1994) 846-849.
- [42] E. Stackebrandt, W. Frederiksen, G. M. Garrity, P. A. Grimont, P. Kampfer, M. C. Maiden, X. Nesme, R. Rossello-Mora, J. Swings, H. G. Trüper, L. Vauterin, A. C. Ward, W. B. Whitman, Report of the ad hoc committee for the re-evaluation of the species definition in bacteriology, *Int. J. Syst. Evol. Microbiol.* 52 (2002)1043-1047.
- [43] F.L. Thompson, B. Hoste, C.C. Thompson, J. Goris, B. Gomez-Gil, L. Huys, P. De Vos, J. Swings, *Enterovibrio norvegicus* gen. nov., sp. nov., isolated from the gut of turbot (*Scophthalmus maximus*) larvae: a new member of the family *Vibrionaceae*, *Int. J. Syst. Evol. Microbiol.* 52 (2002) 2015-2022.
- [44] F.L. Thompson, B. Hoste, K. Vandemeulebroecke, J. Swings, Reclassification of *Vibrio hollisae* as *Grimontia hollisae* gen. nov., comb. nov., *Int. J. Syst. Evol. Microbiol.* 53 (2003) 1615-1617.
- [45] F.L. Thompson, C. C. Thompson, B. Hoste, K. Vandemeulebroecke, M. Gullian, J. Swings, Description of *Vibrio fortis* sp. nov., and *V. hepatarius* sp. nov., isolated from aquatic animals and the marine environment, *Int. J. Syst. Microbiol.* 53 (2003)1495-1501.
- [46] F.L. Thompson, C. C. Thompson, Y. Li, B. Gomez-Gil, J. Vandenberghe, B. Hoste, J. Swings, Description of *Vibrio kanaloae* sp. nov, *Vibrio pomeroyi* sp. nov. and *Vibrio chagasii* sp. nov., from sea water and marine animals, *Int. J. Syst. Evol. Microbiol.* 53 (2003)753-759.
- [47] F.L. Thompson, D. Gevers, C.C. Thompson, P. Dawyndt, S. Naser, B. Hoste, C.B. Munn, J. Swings, Phylogeny and Molecular Identification of Vibrios on the Basis of Multilocus Sequence Analysis, *Appl. Environ. Microbiol.* 71 (2005) 5107-5115.

- [48] J.D. Thompson, D.G. Higgins, T.J. Gibson, CLUSTALW: improving the sensitivity of progressive multiple sequence alignment through sequence weighting, position-specific gap penalties and weight matrix choice, *Nucleic. Acids. Res.* 22 (1994) 4673–4680.
- [49] F.L. Thompson, T. Iida, J. Swings, Biodiversity of vibrios, *Microbiol. Mol. Biol. Rev.* 68 (2004) 403-431.
- [50] F.L. Thompson, Y. Li, B. Gomez-Gil, C. C. Thompson, B. Hoste, K. Vandemeulebroucke, G. S. Rupp, A. Pereira, M. M. De Bem, P. Sorgeloos, J. Swings, *Vibrio neptunius* sp. nov., *V. brasiliensis* sp. nov. and *V. xuii* sp. nov., isolated from the marine aquaculture environment (bivalves, fish, rotifers and shrimps), *Int. J. Syst. Evol. Microbiol.* 53 (2003) 245-252.
- [51] H. Urbanczyk, J.C. Ast, M.J. Higgins, J. Carson, P.V. Dunlap, Reclassification of *Vibrio fischeri*, *Vibrio logei*, *Vibrio salmonicida* and *Vibrio wodanis* as *Aliivibrio fischeri* gen. nov., comb. nov., *Aliivibrio logei* comb. nov., *Aliivibrio salmonicida* comb. nov. and *Aliivibrio wodanis* comb. nov, *Int. J. Syst. Evol. Microbiol.* 57(2007) 2823–2829.
- [52] M.C. Urdaci, L.J. Stal, M. Marchand, Occurrence of nitrogen fixation among *Vibrio* spp, *Arch. Microbiol.* 150 (1988) 224–229.
- [53] L.G. Wayne, D.J. Brenner, R.R. Colwell, P.A.D. Grimont, O. Kandler, L. Krichevsky, L.H. Moore, R.G.E. Murray, E. Stackenbrandt, M.P. Starr, H.G. Truper, Report of the ad hoc committee on reconciliation of approaches to bacterial systematics, *Int. J. Syst. Evol. Microbiol.* 37 (1987) 463-464.

Table 1. Results of pairwise sequence similarities (*mreB*, *gapA*, *gyrB*, *recA*, and *pyrH* genes) of strain MSSRF60^T with its closest relatives.

Type strains	<i>Vibrio plantisponsor</i> (Strain MSSRF60 ^T)				
	<i>recA</i>	<i>gyrB</i>	<i>pyrH</i>	<i>gapA</i>	<i>mreB</i>
<i>V. diazotrophicus</i> LMG 7893 ¹	94.8 %	94.0 %	90.7 %	98.5 %	97.9 %
<i>V. hispanicus</i> LMG 13240 ^T	87.1 %	84.1 %	81.9 %	91.7 %	89.8 %
<i>V. areninigræ</i> J74 ^T	87.5 %	86.5 %	84.6 %	91.5 %	88.9 %

Table 2. Phenotypic features useful for differentiating *Vibrio plantisponsor* sp. nov. MSSRF60^T from its phylogenetic neighbours as evident from 16S rRNA analysis. Taxa are indicated as: 1, *Vibrio plantisponsor* sp. nov.(n=2); 2, *V. diazotrophicus* CAIM 613^T; 3, *V. hispanicus* CAIM 525^T; 4, *V. areninigræ* CAIM 1411^T. +, Positive; -, negative; W, weak positive. All data were from this study.

Characters	1	2	3	4
Isolation source	Mangrove roots	Sea urchins	black sand and <i>Artemia</i> sp.,	Sea water
Growth at 8% NaCl	+	+	+	-
Esculin hydrolysis	+	+	+	-
Acid production from				
D-xylose	+	+	+	-
D-mannose	+	-	+	+
D-lactose	+	+	+	-
D-raffinose	+	-	-	+
Glycogen	+	-	-	+
Utilization of				
D-cellobiose	+	+	+	-
D-mannose	+	-	+	-
Pyruvate	+	-	-	-
Xylose	+	+	+	-
L-leucine	+	-	-	W
L-ornithine	+	+	W	W
Potassium gluconate	+	-	+	+

Supplementary Table S1: Whole cell fatty acid composition of *V. plantisponsor* and related *Vibrio* species. Cultivation on marine agar at 28°C for 1 day. Percentages of total fatty acids (parts higher than 0.5 % in one of the strains are listed). 1, Strain MSSRF60^T; 2, MSSRF64; 3, *V. diazotrophicus* DSM 2604^T; 4, *V. hispanicus* DSM 16580^T; 5, *V. areninigrae* DSM 22054^T. All data obtained in this study

Fatty acid	1	2	3	4	5
C _{12:0}	4.5	4.4	4.2	3.9	4.6
Unknown 12.484	0.7	0.7	0.9	0.7	1.0
C _{12:0} -3OH	3.4	3.3	3.0	3.0	3.2
iso-C _{14:0}	0.6	0.7	0.5	0.2	0.3
C _{14:0}	5.7	5.6	2.3	3.0	7.4
C _{15:0}	0.4	0.4	0.3	0.6	0.7
C _{16:1} ω7c alcohol	-	-	-	0.2	0.7
Feat. 2 incl. iso-C _{16:1} and C _{14:0} -3OH	3.3	3.2	2.8	2.6	2.9
iso-C _{16:0}	2.4	2.6	2.7	1.6	1.2
Feat. 3 incl. C _{16:1} ω7c	33.9	32.7	35.9	38.9	38.3
C _{16:0}	24.2	24.4	22.9	21.1	24.9
C _{17:1} ω8c	0.3	0.3	0.3	0.8	0.4
C _{17:0}	0.2	0.3	0.2	0.8	0.3
C _{18:1} ω7c and C _{18:1} ω6c	17.7	18.4	19.1	19.4	11.9
C _{18:0}	0.6	0.7	0.7	0.6	0.3
11-methyl-C _{18:1} ω7c	0.2	0.3	0.3	0.4	0.7
Feat. 7 incl. C _{19:1} ω6c	0.5	0.4	1.6	0.1	0.2

Fig. 1. Phylogenetic tree based on 16S rRNA gene sequences constructed using neighbour-joining method, showing the phylogenetic placement of strains MSSRF60^T, MSSRF64 and their phylogenetic neighbours of the genus *Vibrio*. Bootstrap percentages (based on 1000 replicates) are indicated at branching points (values >50% are shown).

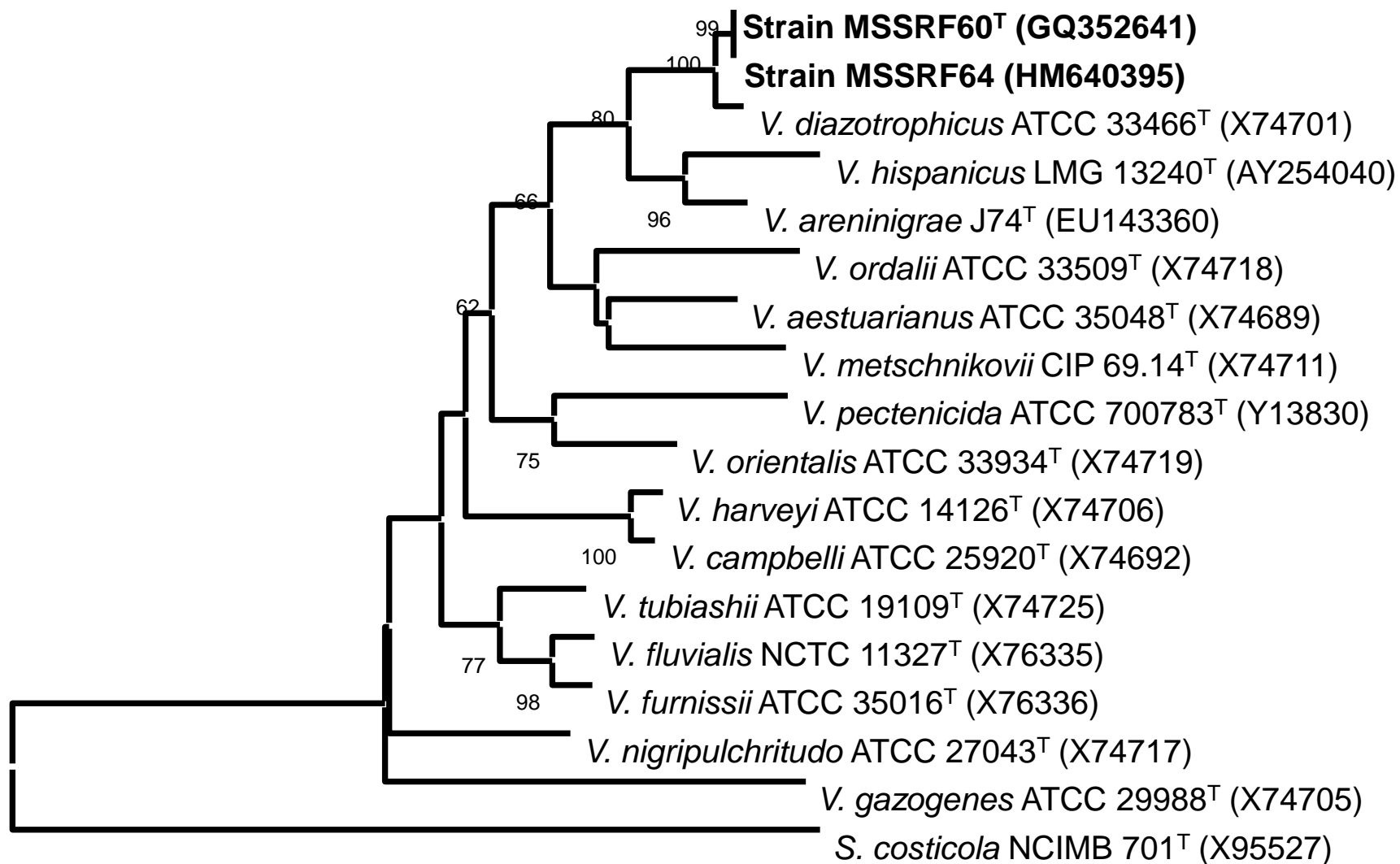

0.01

Fig 2. Neighbor-joining phylogeny of concatenated sequences of *recA*, *mreB*, *gyrB*, *gapA* and *pyrH* genes from strains MSSRF60^T and MSSRF64 and its closely related species of *Vibrio*. Distances were calculated according to Kimura's two-parameter correction. Bootstrap analysis was based on 1000 resamplings.

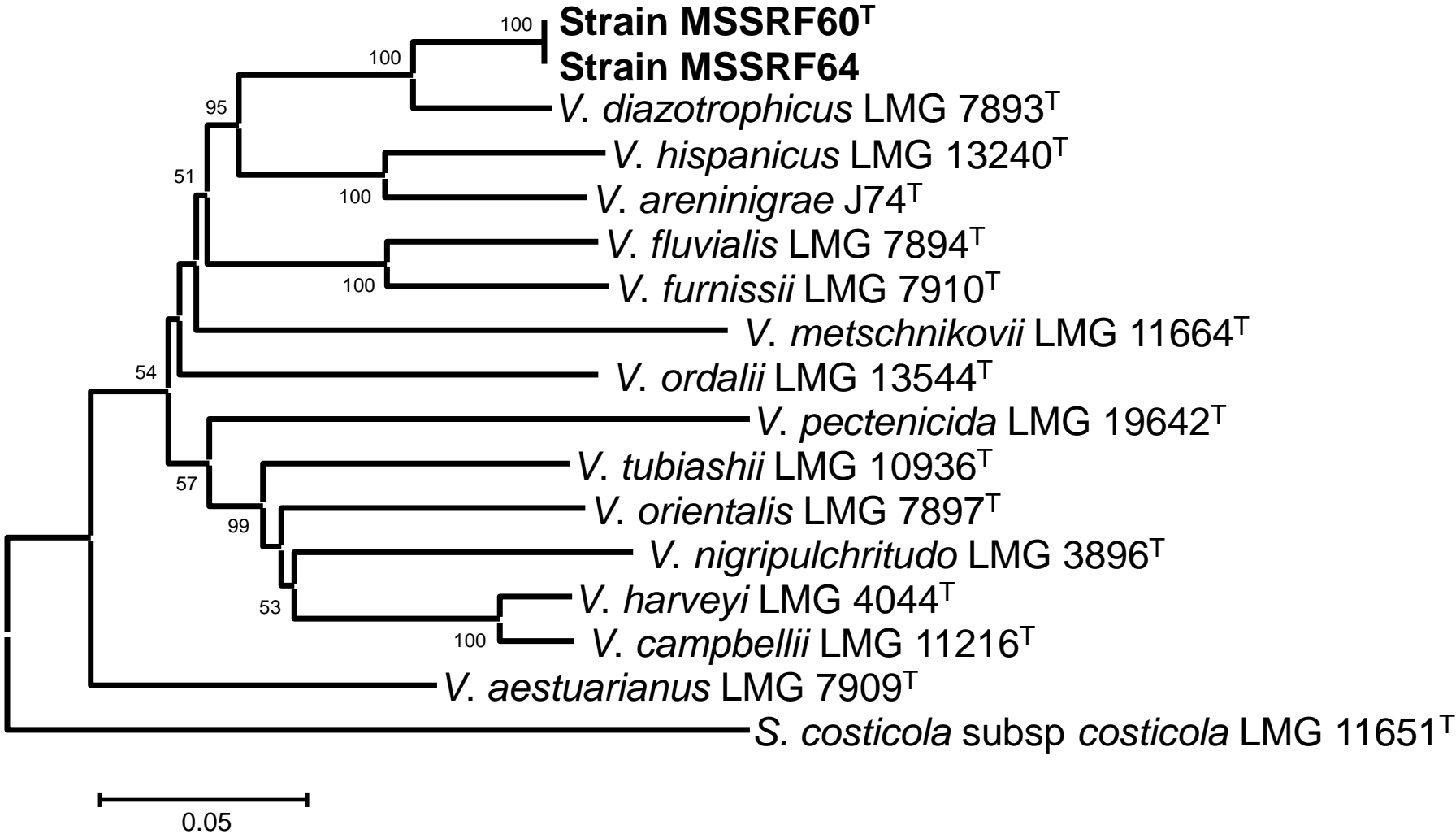

Fig. 3. Genomic fingerprinting using BOX-PCR, cluster analysis of two isolates MSSRF60^T, MSSRF64 and its closest phylogenetic neighbours as evident from 16S rRNA analysis.

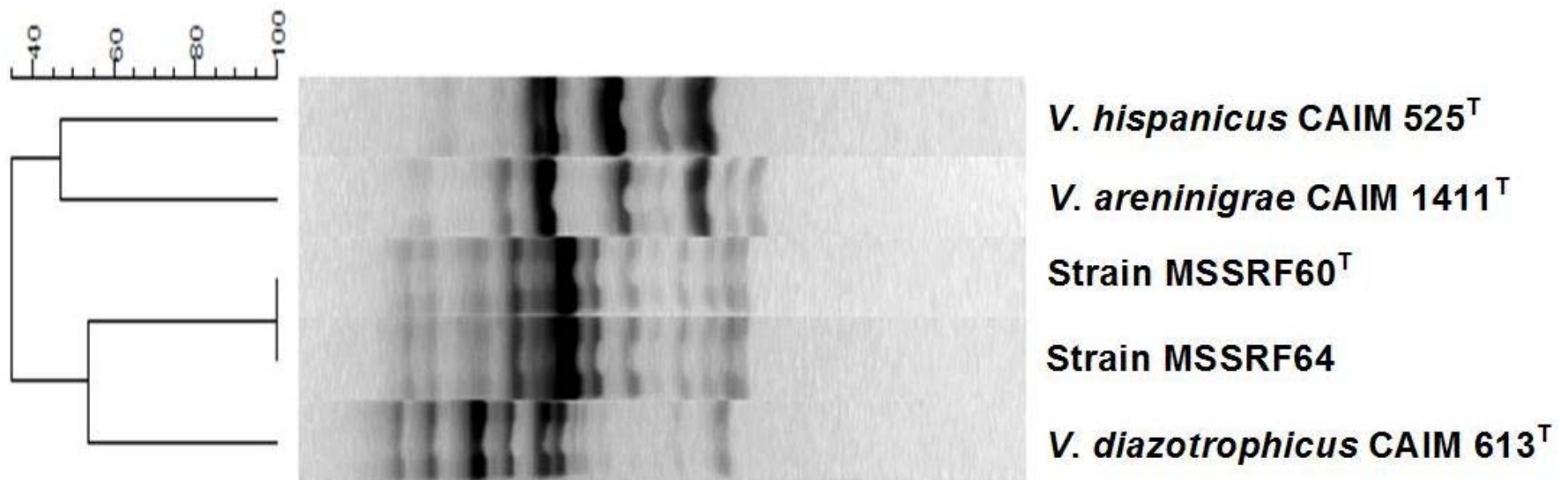
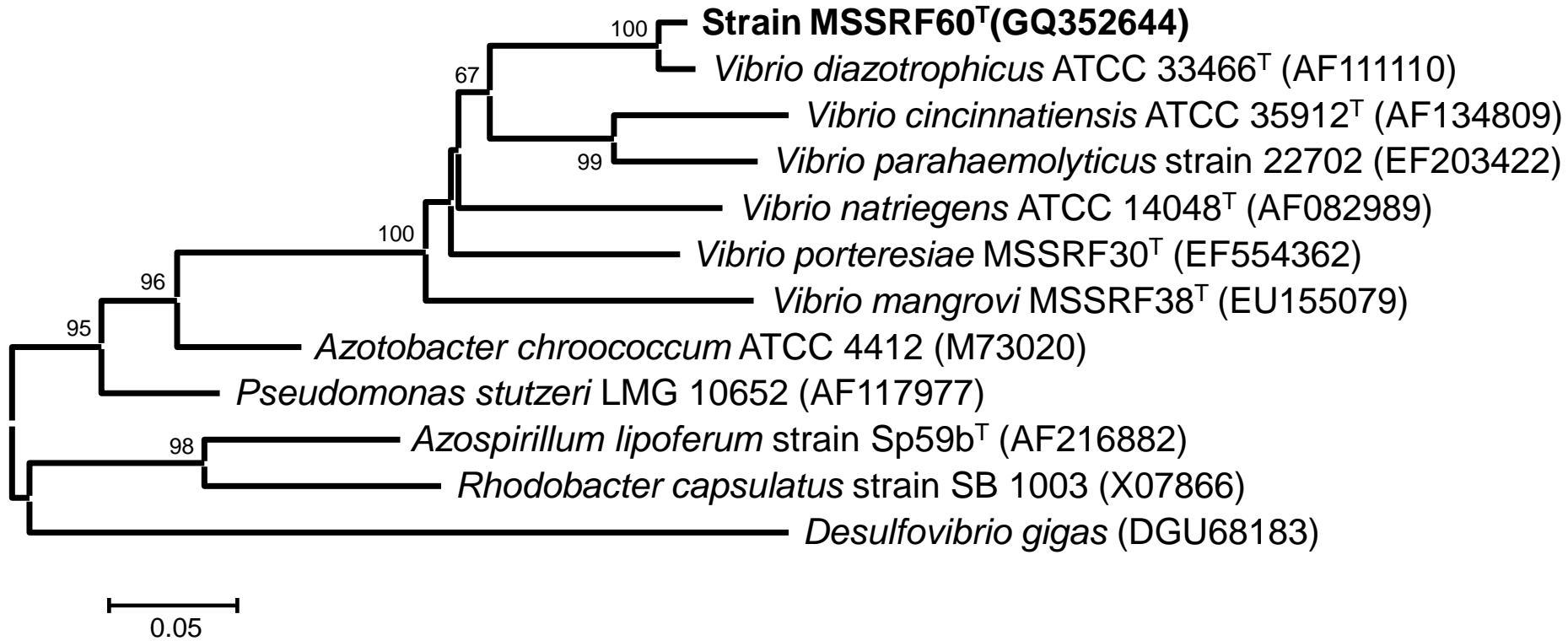
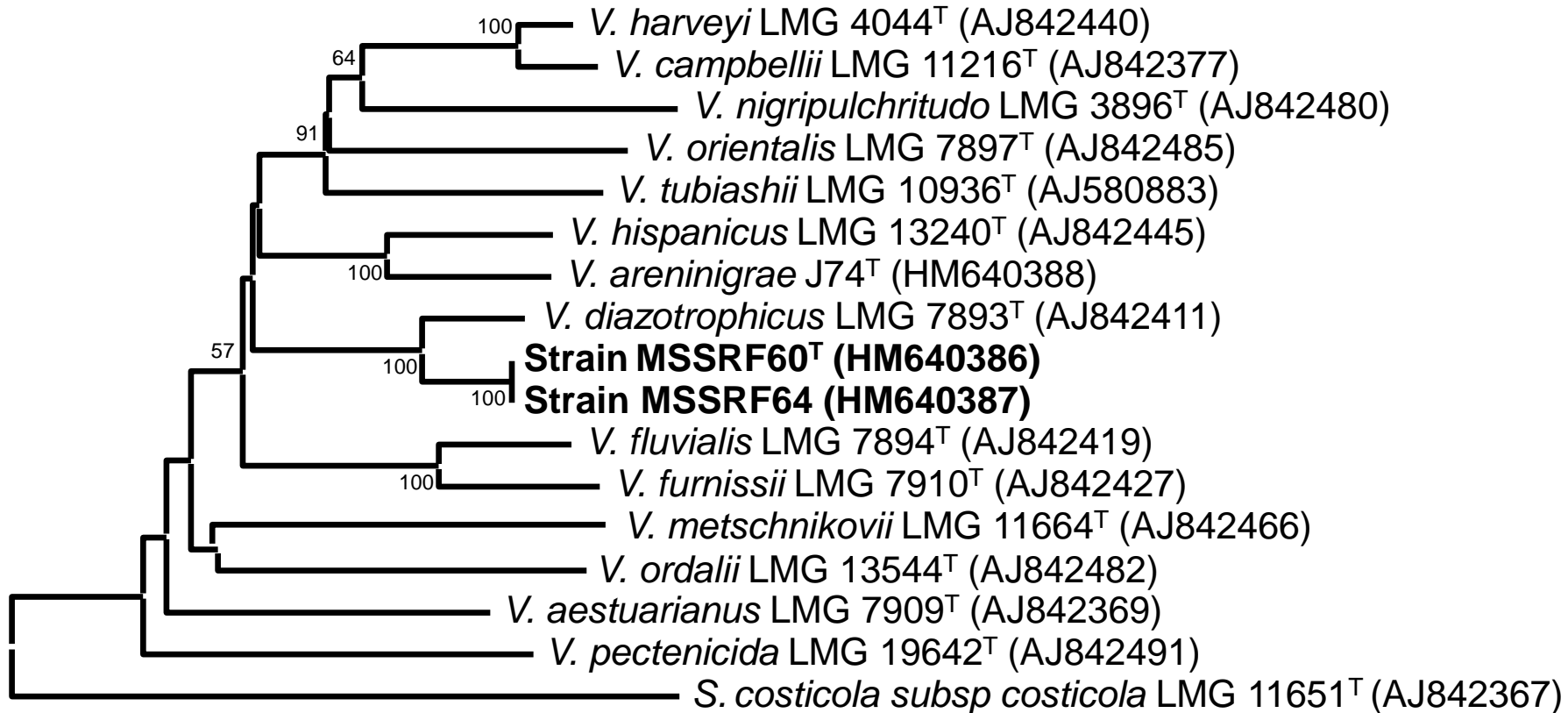

Fig. 4. Neighbour joining tree based on partial *nifH* sequences of MSSRF60^T showing the phylogenetic relationships with *nifH* sequences from nitrogen fixing *Vibrio* species and other *nifH* sequences of related organisms. Bootstrap percentages (based on 1000 replicates) are indicated at branching points (values >50% are shown).



Supplementary Fig. S1. Phylogenetic tree based on *recA* gene sequences constructed using neighbour-joining method, showing the phylogenetic placement of strains MSSRF60^T, MSSRF64 and their phylogenetic neighbours of the genus *Vibrio*. Bootstrap percentages (based on 1000 replicates) are indicated at branching points (values >50% are shown).



Supplementary Fig. S2. Phylogenetic tree based on *gyrB* gene sequences constructed using neighbour-joining method, showing the phylogenetic placement of strains MSSRF60^T, MSSRF64 and their phylogenetic neighbours of the genus *Vibrio*. Bootstrap percentages (based on 1000 replicates) are indicated at branching points (values >50% are shown).

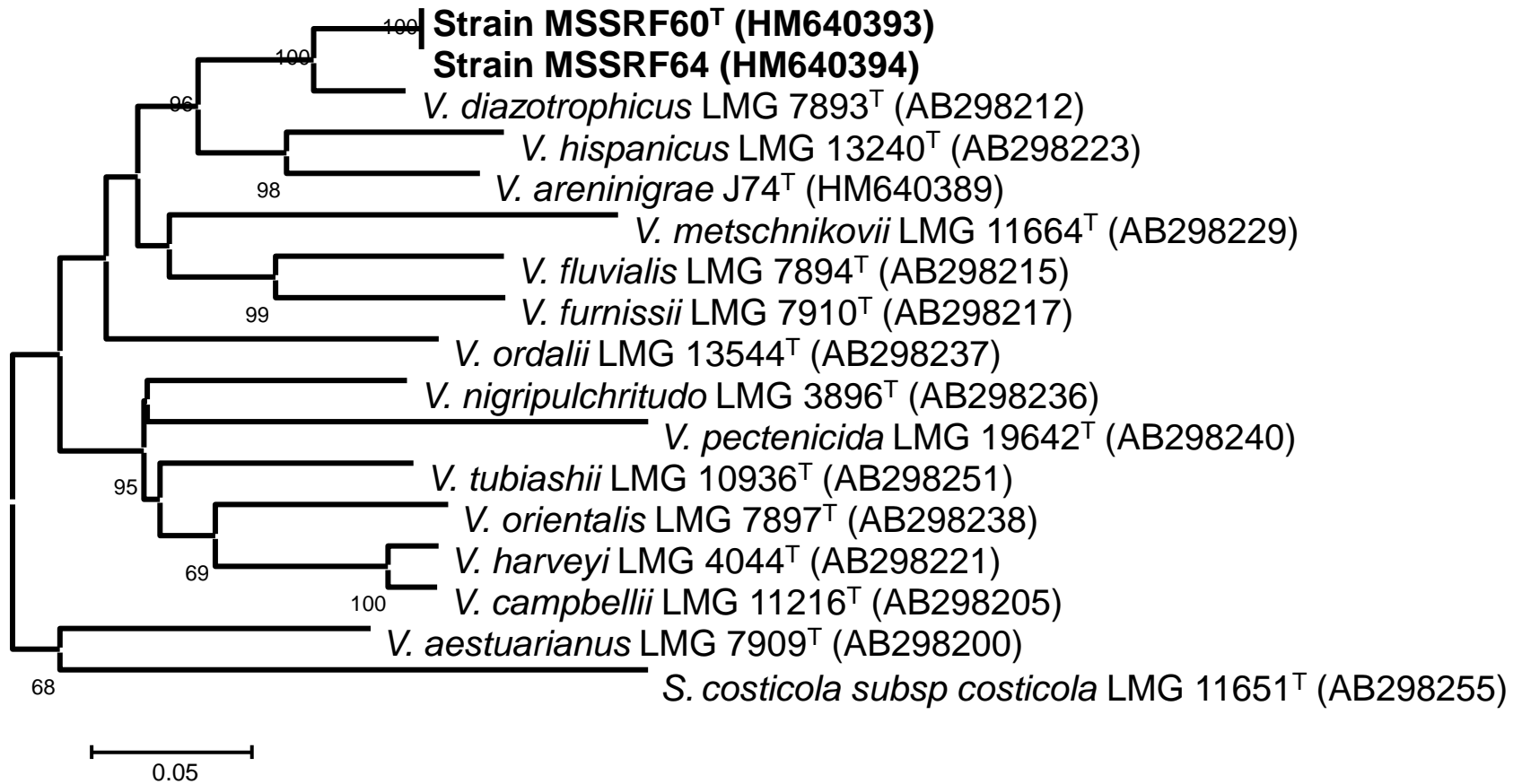

Supplementary Fig. S3. Phylogenetic tree based on *pyrH* gene sequences constructed using neighbour-joining method, showing the phylogenetic placement of strains MSSRF60^T, MSSRF64 and their phylogenetic neighbours of the genus *Vibrio*. *pyrH* gene sequences were obtained from TaxVibrio database (<http://www.taxvibrio.lncc.br/>). Bootstrap percentages (based on 1000 replicates) are indicated at branching points (values >50% are shown).

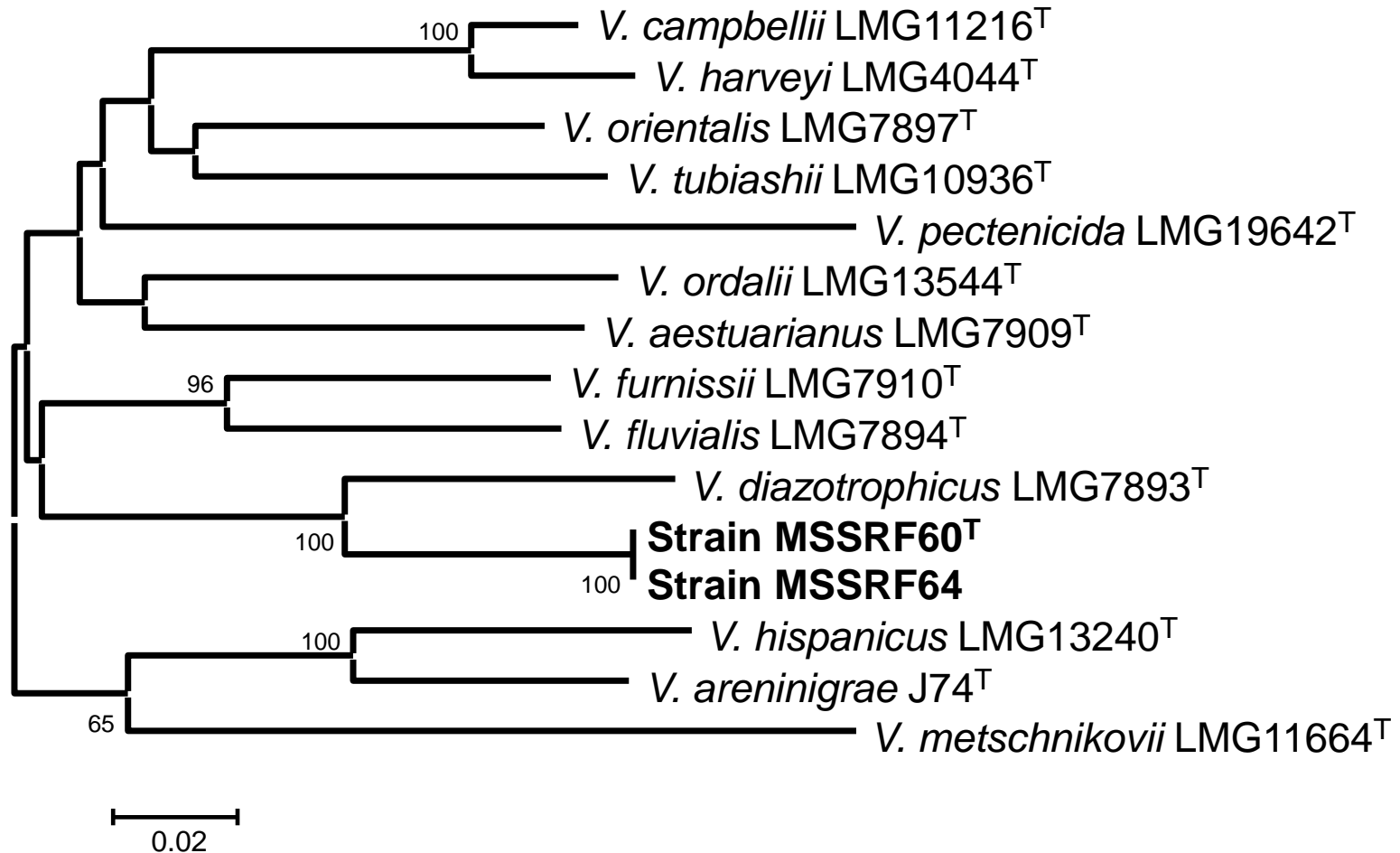

Supplementary Fig. S4. Phylogenetic tree based on *gapA* gene sequences constructed using neighbour-joining method, showing the phylogenetic placement of strains MSSRF60^T, MSSRF64 and their phylogenetic neighbours of the genus *Vibrio*. Bootstrap percentages (based on 1000 replicates) are indicated at branching points (values >50% are shown).

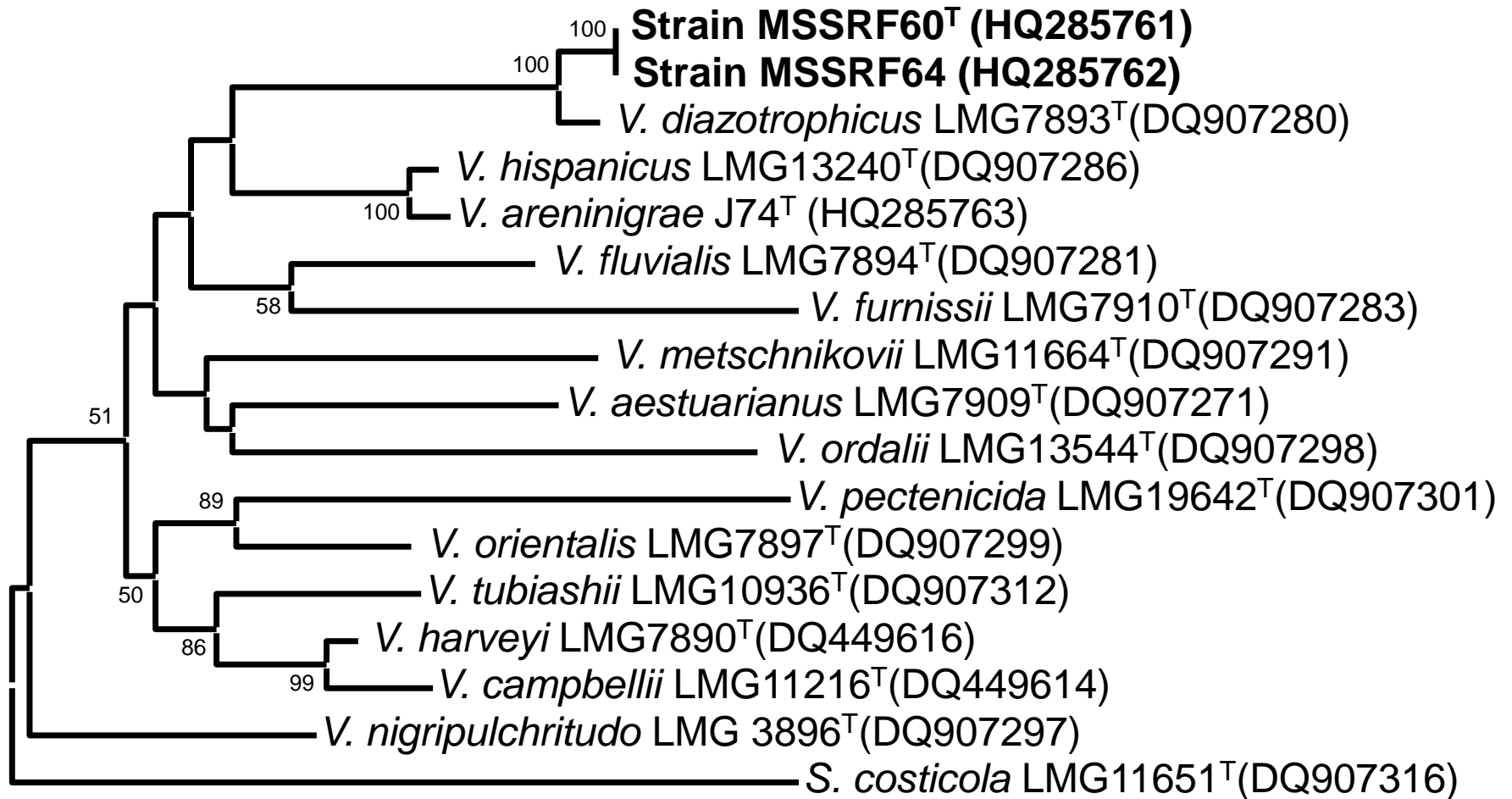

0.02

Supplementary Fig. S5. Phylogenetic tree based on *mreB* gene sequences constructed using neighbour-joining method, showing the phylogenetic placement of strains MSSRF60^T, MSSRF64 and their phylogenetic neighbours of the genus *Vibrio*. Bootstrap percentages (based on 1000 replicates) are indicated at branching points (values >50% are shown).

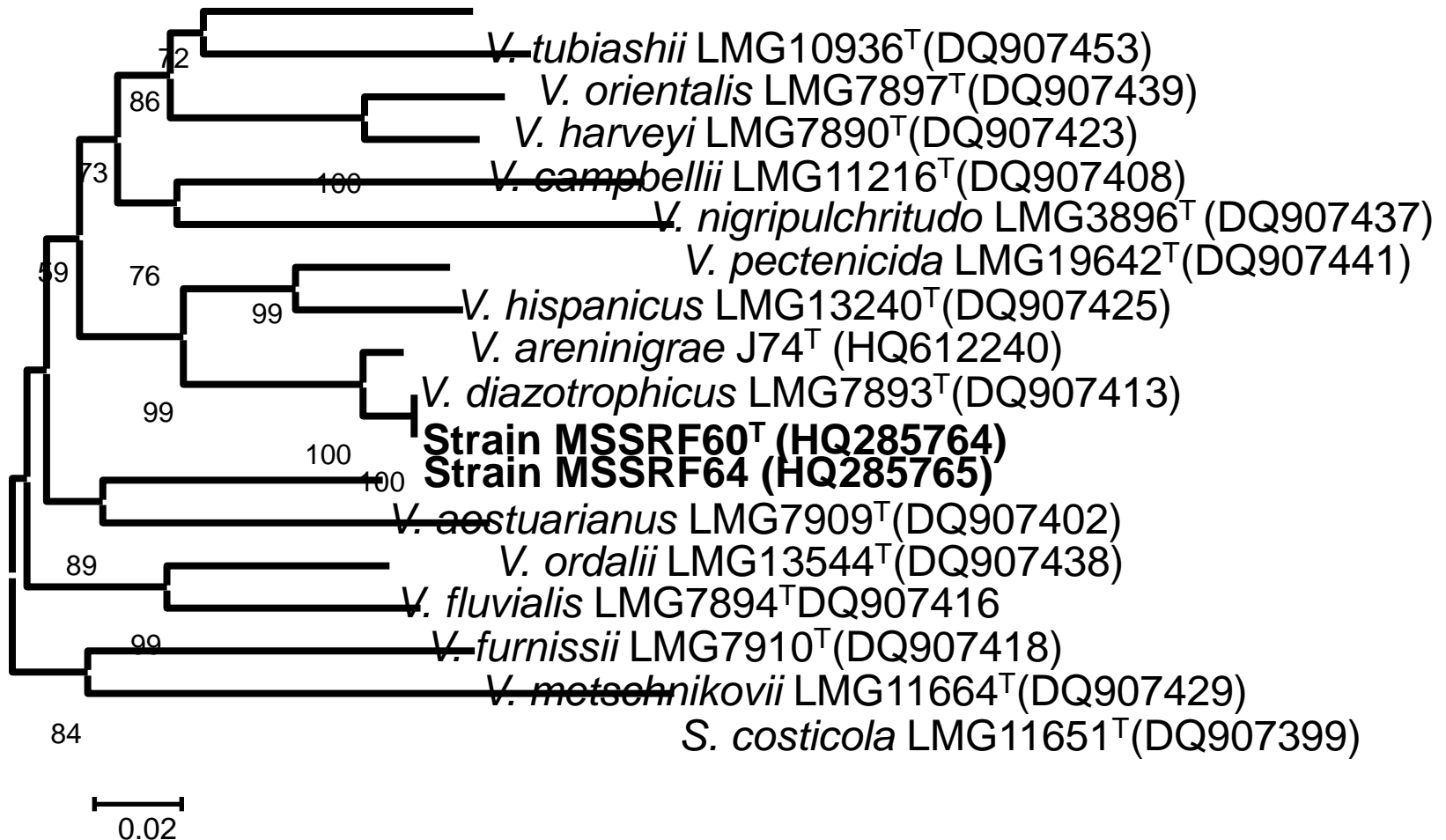

Supplementary Fig. 6. The DNA-DNA relatedness obtained for strain MSSRF60^T=CAIM 1392^T and CAIM 525^T (a), between CAIM 1392^T and CAIM 613^T (b), between CAIM 1392^T and CAIM 1411^T (c) and between CAIM 525^T and CAIM 1411^T, positive control (d). The DNA-DNA relatedness was measured by the difference in ΔT_m of the type strain and the hybrid of the proposed new species strain and the type strain as described in text.

