

Acquisition Performance of an Automatic Phase-shifting Loop

P. E. SANKARANARAYANAN

National Institute of Oceanography, Panaji, Goa

Received 19 August 1974; revised received 4 January 1975

Acquisition performance of an automatic phase-shifting loop has been discussed for four different types of loop-filter configurations. The proposed loop, essentially employs the Sanky phase shifter—a frequency-independent voltage-controlled phase shifter—for phase compensation. System equations have been derived for all the cases and expressions for the acquisition time have been obtained for constant phase shift. It has been found that a practical system based on the linear model concept is the best from the point of view of the measurement of the phase angle difference.

1. Introduction

PHASE-SHIFTING networks are often employed to compensate for the phase shifts occurring or to introduce necessary phase shifts in instrumentation systems. Such networks may be employed for the measurement of the phase angle difference between two signals of the same frequency, through automatic phase compensation or null balancing. A frequency-independent voltage-controlled phase-shifter like the Sanky phase-shifter¹⁻³ has been found to be ideally suited for this purpose, while measurement of the phase angle at different frequencies are involved. A closed-loop system, employing such a phase-shifter within the loop, can be studied in a way similar to the studies carried out on phase-lock loops⁴⁻⁷. In this paper, the acquisition performance of the proposed automatic phase-shifting loop, for four different types of loop filter configurations, when the two input signals have a constant phase shift, has been presented.

2. Automatic Phase-shifting Loop Operation

Fig. 1 shows the loop configuration. Here e_s and e_r are the input voltages having the same angular frequency ω , and e_s differs in phase by ϕ from e_r . The term e_0 is the output of the Sanky phase shifter (SPS). The output of the multiplier (M) (a conventional phase detector), viz. e_1 is fed to a low-pass filter $F(S)$. The voltage output e_2 of this filter acts as the input phase control voltage to the SPS.

$$\text{Let, } e_s = E_s \cdot \sin \phi_s \quad \dots(1)$$

$$e_r = E_r \cdot \sin \phi_r \quad \dots(2)$$

$$\text{and } e_0 = \frac{4E_0}{\pi} \cdot \sin \phi_0 \quad \dots(3)$$

where e_0 is the first harmonic approximation of the square-wave output of SPS.

The voltage e_1 is given by

$$\begin{aligned} e_1 &= \frac{4E_s E_0}{\pi} \cdot \sin \phi_s \cdot \sin \phi_0 \\ &= K_1 [\cos(\phi_s - \phi_0) + \cos(\phi_s + \phi_0)] \dots(4) \end{aligned}$$

$$\text{where, } K_1 = \frac{2E_s E_0}{\pi}$$

This is passed through the filter $F(S)$ having essentially a low-pass characteristic. Hence the sum phase term is filtered out.

Therefore,

$$e_2 = K_1 F(S) \cdot \cos(\phi_s - \phi_0) \quad \dots(5)$$

It has been proved already that the Sanky phase shifter is essentially a phase modulator⁸ governed by the equation

$$\phi_0 = \phi_r - K_2 e_2 \quad \dots(6)$$

Now Eq. (5) can be rewritten as

$$e_2 = K_1 \cdot F(S) \cdot \cos[(\phi_s - \phi_r) + K_2 e_2] \dots(7)$$

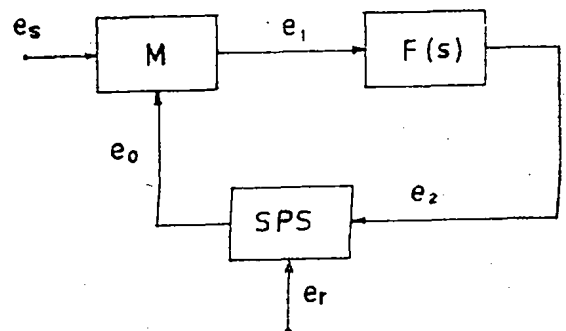

Fig. 1—Schematic arrangement of the configuration phase shifting loop

Since ϕ_s and ϕ_r in general will be as

$$\phi_s = \omega t - \phi \quad \dots(8)$$

and $\phi_r = \omega t \quad \dots(9)$

$$(\phi_s - \phi_r) = -\phi \quad \dots(10)$$

Hence $e_2 = K_1 \cdot F(S) \cdot \cos[K_3 e_2 - \phi] \quad \dots(11)$

This governing equation of the automatic phase-shifting loop shown in Fig. 1, has been used in the following sections to study the performance of the loop for the four different loop filter configurations.

3. Zero-order Loop with Constant Phase Shift

The simple filter considered first is the one that has no energy storage elements and thus, has a constant as transfer function.

Let, $F(S) = K_2$

Therefore,

$$e_2 = K_1 K_2 \cos(K_3 e_2 - \phi) \quad \dots(12)$$

If $\left(\frac{\pi}{2} + \phi - K_3 e_2\right)$ is small and $K_1 K_2 K_3 \gg 1$

Eq. (12) can be approximated as

$$\delta e = \frac{\phi}{K_3} \quad \dots(13)$$

where $\delta e = \left(e_2 - \frac{\pi}{2K_3}\right)$

Eq. (13) gives the linear relationship between ϕ and δe . However, to consider the pull-in behaviour, the non-linear Eq. (12) has to be considered.

Normalizing e_2 as, $e = \frac{e_2}{K_1 K_2}$ in Eq. (12)

$$e = \cos(K e - \phi) \quad \dots(14)$$

where, $K = K_1 K_2 K_3$

When there is phase coincidence, then

$$(K e - \phi) = 0$$

Therefore, $e = 1$

and,

$$(K - \phi) = 2n\pi \quad \text{where } n = 0, 1, 2, \dots$$

$$\text{or } K = \phi + 2n\pi \quad \dots(15)$$

Also, when

$$e = 0; \phi = \frac{\pi}{2}$$

The solutions of Eq. (14) are shown in Fig. 2 with K as the parameter. It can be seen, in the range of $\phi = -3\pi/2$ to $+\pi/2$, the response monotonically increases only for the case, $K \geq \pi/2$. For values of $K < \pi/2$, the function is not single valued with respect to e . Similarly, for $K > \pi/2$, a multivalued function results, although the range of ϕ is increased. It may be seen that for constant K , since e is a function of ϕ , strict null balance cannot be obtained in phase. Thus, in order to achieve phase compensation fully, i.e. for 'locking' for various phase angles ϕ , the values of K have to be different. To arrive at a practical circuit in this way is difficult.

4. First Order Loop with Constant Phase Shift

In this section are considered the following two first-order filter configurations :

$$F(R) = -\frac{1}{S\tau}$$

and $F(S) = -\frac{K_2(1 + S\tau)}{S\tau}$

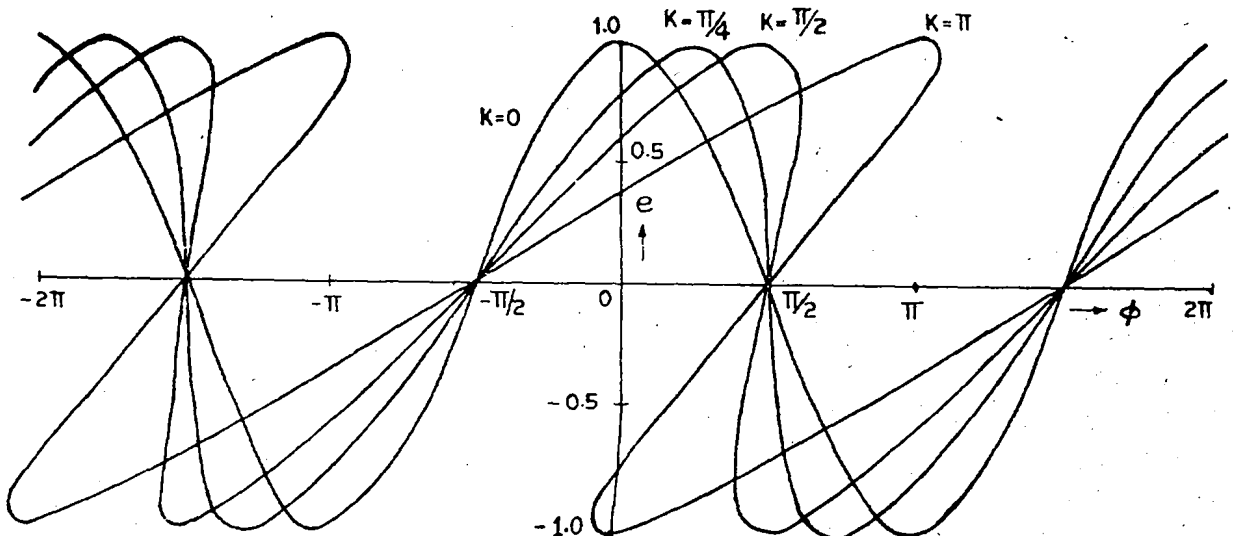

Fig. 2—Solutions of Eq. (14)

Figs. 3 (a) and (b) respectively show the above two filter transfer functions.

Considering

$$F(S) = - \frac{1}{S\tau} \quad \text{where } \tau = RC$$

Eq. (11) can be rewritten in the form

$$e_2 = - \frac{K_1}{S\tau} \cdot \cos (K_3 e_2 - \phi) \quad \dots(16)$$

Calling $(K_3 e_2 - \phi) = \alpha$

$$\frac{d\alpha}{dt} = - \frac{K}{\tau} \cdot \cos \alpha \quad \dots(17)$$

where, $K = K_1 K_3$

Letting $t = \frac{\tau}{K} \cdot \lambda$; $dt = \frac{\tau}{K} \cdot d\lambda$

and calling $\frac{d\alpha}{d\lambda} = v$

$$v = \cos (\pi + \alpha) \quad \dots(18)$$

Fig. 4 shows v plotted against α . When the lock occurs, i.e. $v = 0$, the minimum phase error is $\pm \pi/2$. The pull-in time can be determined from Eq. (17), as

$$\int_{\alpha(\text{initial})}^{\alpha(\text{final})} \frac{d\alpha}{\cos (\pi + \alpha)} = \frac{K}{\tau} \cdot t \quad (19)$$

Value of $\alpha(\text{final})$ cannot be taken as $\pm \pi/2$, since in this case, the denominator becomes zero and the

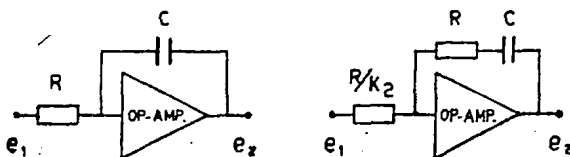

(a)

(b)

Fig. 3—Filter configurations considered in the study

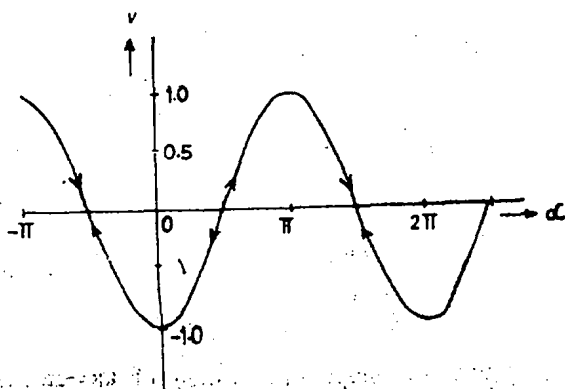

Fig. 4—Plot of v versus α

integral becomes infinite. However, to get a meaningful result, $\alpha(\text{final})$ may be taken as slightly less than $\pm \pi/2$ and the time required to reach it may be evaluated. On integration Eq. (19) yields,

$$\log \left[\tan \left(\frac{\alpha}{2} + \frac{3\pi}{4} \right) \right]_{\alpha(\text{initial})}^{\alpha(\text{final})} = \frac{K}{\tau} \cdot t \quad \dots(20)$$

where $\alpha(\text{initial}) = \phi$, since e_2 to start with is zero. The value of t in Eq. (20) gives the pull-in time and it is dependent on the initial phase difference.

Now, considering, $F(S) = - \frac{K_2 (1 + S\tau)}{S\tau}$

Eq. (11) can be rewritten as

$$e_2 = - \frac{K_1 K_2 (1 + S\tau)}{S\tau} \cdot \cos (K_3 e_2 - \phi) \quad \dots(21)$$

calling as before, $\alpha = (K_3 e_2 - \phi)$ and $K = K_1 K_2 K_3$,

and letting $t = \frac{\tau}{K} \cdot \lambda$

$$\frac{d\alpha}{d\lambda} = \frac{-\cos \alpha}{1 - K \sin \alpha} \quad \dots(22)$$

Since, $K = 4 \xi^2$ where ξ is the damping coefficient of the circuit,

$$v = \frac{-\cos \alpha}{1 - 4\xi^2 \sin \alpha} \quad \dots(23)$$

Fig. 5 shows the plot of Eq. 23 for values of $\xi = 0.5, 0.707, 1.0$ and 1.414 . As can be seen, v becomes zero at the points $\alpha = -\pi/2, \pi/2, 3\pi/2$, etc. Only in the case of $\xi = 0.5$ for $\alpha = \pi/2$, v becomes infinite. This shows the loop will lock, in general, when α reaches $(2n + 1)(\pi/2)$, n being an integer. In order to see whether this singular point is stable or not, the value of the acceleration at these points may be considered. Differentiating Eq. (23) with respect to λ

$$\frac{dv}{d\lambda} = \frac{v[\sin \alpha + 4 \xi^2 v \cos \alpha]}{1 - 4 \xi^2 \sin \alpha} \quad \dots(24)$$

Thus, whenever $v = 0$; $\frac{dv}{d\lambda} = 0$

Thus, these singular points are stable. Now, to estimate the pull-in time, Eq. (22) is rearranged and used as follows:

$$\int_{\alpha(\text{initial})}^{\alpha(\text{final})} \frac{(1 - K \sin \alpha)}{\cos (\pi + \alpha)} \cdot d\alpha = \frac{K}{\tau} \cdot t \quad \dots(25)$$

Since, when $\alpha(\text{final}) = \pm \pi/2$; the denominator becomes zero and the integral becomes infinite; as before, to get a meaningful result, $\alpha(\text{final})$ may be

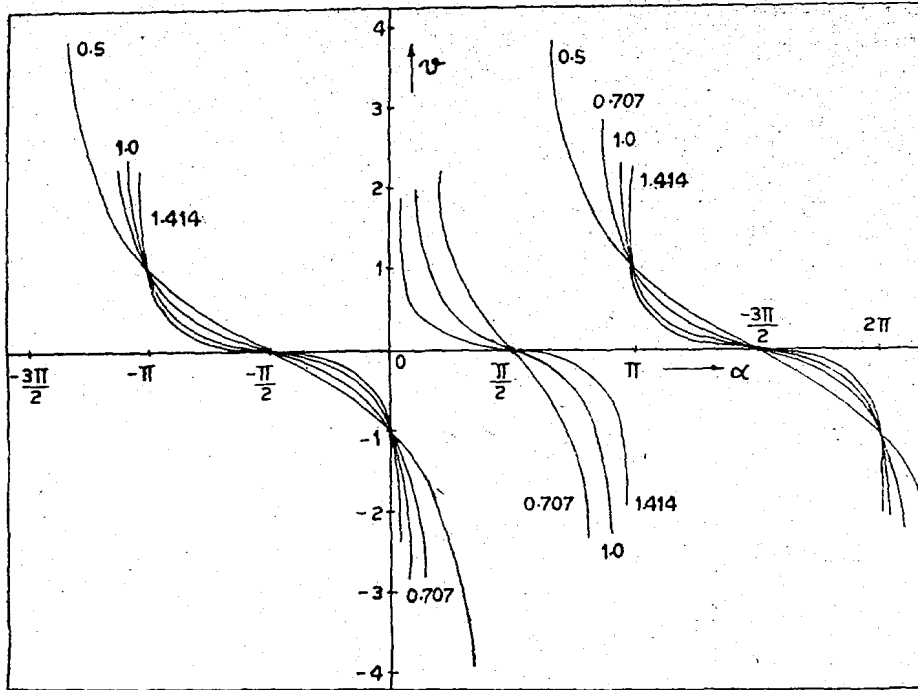

Fig. 5—Plot of Eq. (23) for different values of ξ

taken as slightly less than $\pm \pi/2$ and the time required to reach it may be evaluated. On integration, Eq. (25) yields

$$t = \frac{\tau}{K} \left\{ \log \left[\tan \left(\frac{\alpha}{2} + \frac{3\pi}{4} \right) \right] + K \log(\cos \alpha) \right\}_{\alpha(\text{initial})}^{\alpha(\text{final})} \quad \dots(26)$$

5. Second Order Loop with Constant Phase Shift

In this section is considered a second order filter in the loop, having a transfer function

$$F(S) = \frac{K_2(1 + S\tau)}{S^2\tau^2}$$

The circuit configuration of the filter having the above transfer function can be achieved by the combination of both the filters shown in Fig. 3. Now, Eq. (11) can be written in the form

$$e_2 = \frac{K_1 K_2 (1 + S\tau)}{S^2 \tau^2} \cdot \cos(K_3 e_2 - \phi) \quad \dots(27)$$

calling as before $\alpha = (K_3 e_2 - \phi)$

$$\frac{d^2 \alpha}{dt^2} + \frac{K}{\tau} \cdot \sin \alpha \cdot \frac{d\alpha}{dt} - \frac{K}{\tau^2} \cdot \cos \alpha = 0 \quad \dots(28)$$

Now, calling $K/\tau = 2\xi\omega_n$ and $K/\tau^2 = \omega_n^2$ where the dimension of K is that of the phase angle, Eq. (28) becomes,

$$\frac{d^2 \alpha}{dt^2} + 2\xi\omega_n \cdot \sin \alpha \cdot \frac{d\alpha}{dt} - \omega_n^2 \cdot \cos \alpha = 0 \quad \dots(29)$$

Normalizing $t = \frac{\lambda}{2\xi\omega_n}$; $dt = \frac{d\lambda}{2\xi\omega_n}$

$$\frac{d^2 \alpha}{d\lambda^2} + \sin \alpha \cdot \frac{d\alpha}{d\lambda} - \frac{\cos \alpha}{4\xi^2} = 0 \quad \dots(30)$$

This is a second order non-linear differential equation, the solution of which cannot be obtained in a closed form, and hence phase-plane technique is followed² to investigate Eq. (30).

Now putting $d\alpha/d\lambda = v$ as before, Eq. (30) becomes,

$$\frac{dv}{d\lambda} + v \sin \alpha - \frac{\cos \alpha}{4\xi^2} = 0 \quad \dots(31)$$

Dividing by $v = d\alpha/d\lambda$ throughout,

$$\frac{dv}{d\alpha} + \sin \alpha - \frac{\cos \alpha}{4\xi^2 v} = 0 \quad \dots(32)$$

and rearranging

$$v = \frac{(\cos \alpha)/4\xi^2}{\frac{dv}{d\alpha} + \sin \alpha} \quad \dots(33)$$

Eq. (33) gives the slope of a system of trajectories corresponding to different instantaneous phase errors.

The following observations can be made from an inspection of Eq. (32).

(i) For large values of v , i.e. when de_s/dt is large,

$$\frac{dv}{d\alpha} = -\sin \alpha$$

That is, the trajectories are sinusoidal.

(ii) For $\alpha = 0$, i.e. when $K_2 e_s = \phi$

$$\frac{dv}{d\alpha} = \frac{1}{4\xi^2 v}$$

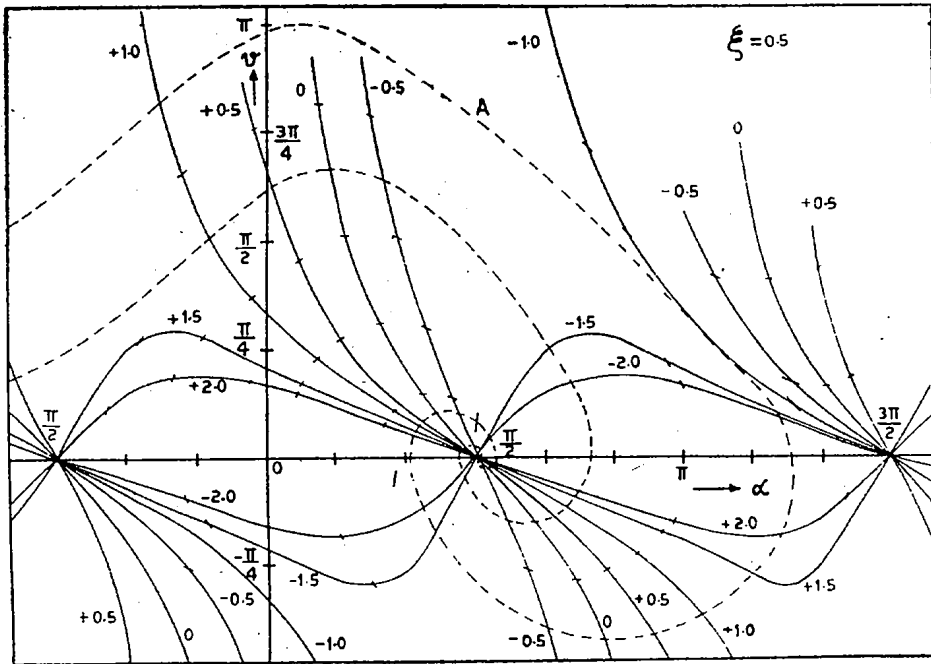

Fig. 6—Phase plots for $\xi = 0.5$

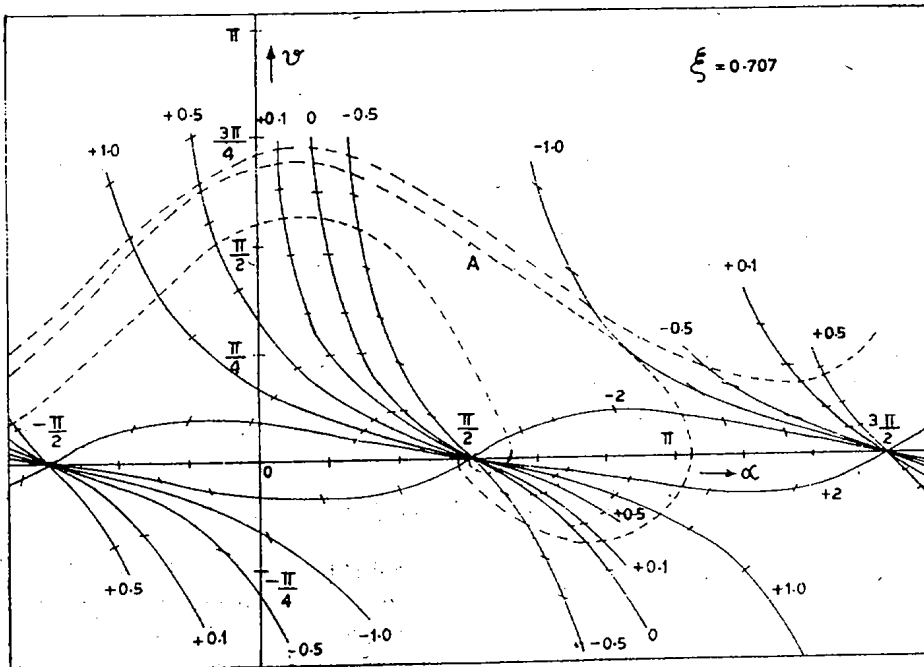

Fig. 7—Phase plots for $\xi = 0.707$

SANKARANARAYANAN : AUTOMATIC PHASE-SHIFTING LOOP

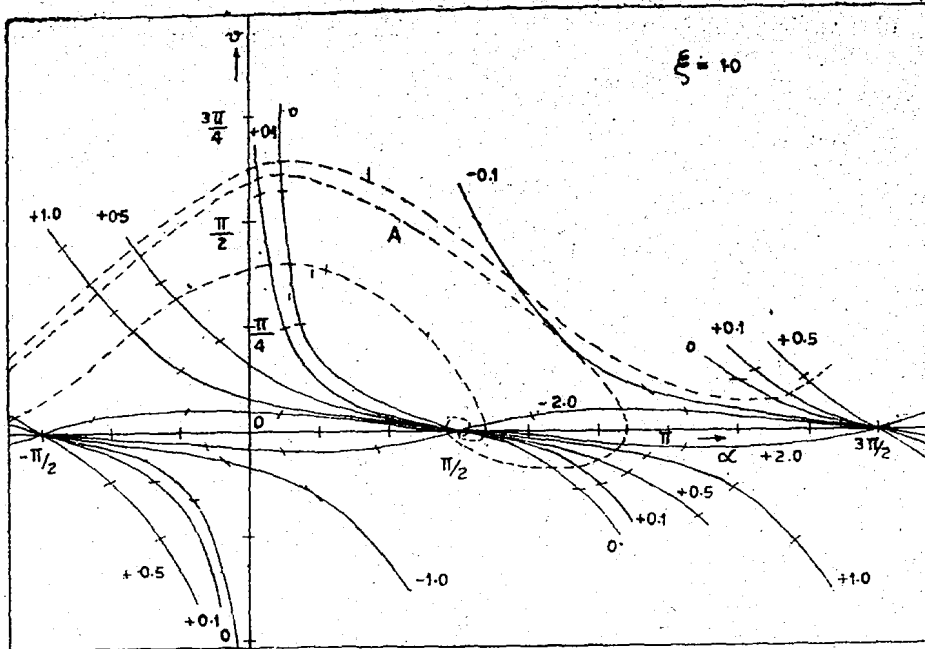

Fig. 8—Phase plots for $\xi = 1$

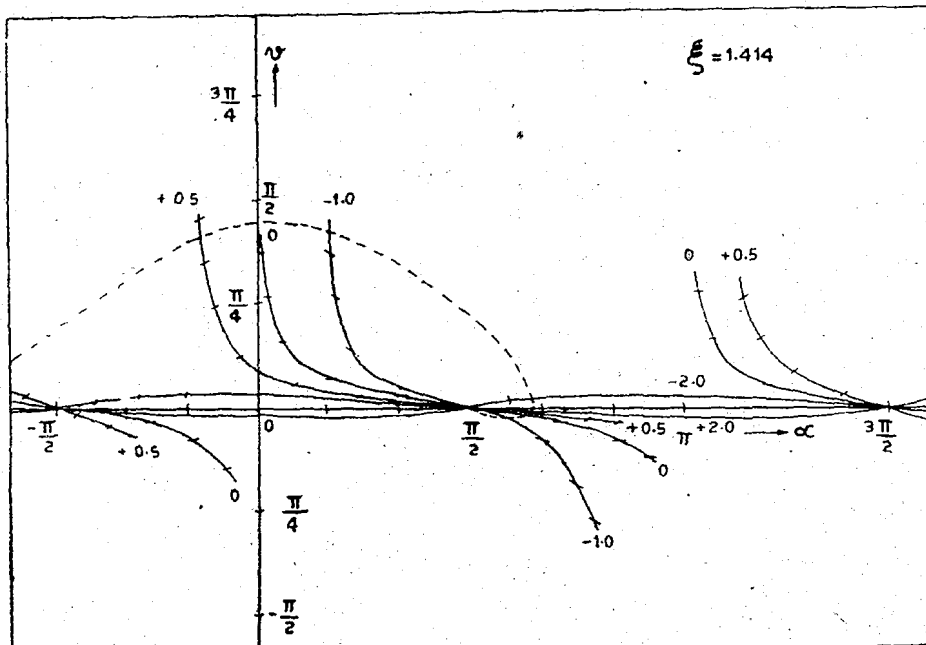

Fig. 9—Phase plots for $\xi = 1.414$

(iii) For $\alpha = \pm (2n + 1) \frac{\pi}{2}$, $n = 0, 1, 2$, etc.

$$\frac{dv}{d\alpha} = -1$$

and

(iv) For $v = 0$, $\alpha = \pm (2n + 1) \frac{\pi}{2}$

The first term becomes indeterminate and these points are called singular points. They denote either stable or unstable equilibrium of the system. Also at these points, acceleration is zero. This follows from Eq. (31).

Eq. (33) has been utilized to draw the phase plots for the values of $\xi = 0.5, 0.707, 1.00$ and 1.414 . These phase plots are shown in Figs. 6-9. These figures indicate that for large values of v , i.e. ; de_2/dt either positive or negative, the trajectories are sinusoids. Curve A in Fig. 6, is the 'limit trajectory' which leads to synchronization. This shows that any trajectory coming within this 'limit trajectory', leads to lock within one phase cycle or one period of the input sine wave. Trajectories falling outside the zone of the limit trajectory lead to lock-in more than one phase cycle, and as such 'cycle slipping' occurs^{5,7}. The number of phase cycles needed in this case is, however, a function of the initial velocity of arrival, which is also a function of de_2/dt . It may be mentioned that, de_2/dt is again a function of the phase difference ϕ .

Considering the 'limit trajectory', the maximum value of the velocity v_{max} with which the loop locks within one phase cycle, gives the pull-in phase or capture phase angle. Let the capture ratio γ be defined in this case as :

$$\gamma = \frac{\text{Maximum phase shift in one phase cycle}}{\text{Gain in the system}}$$

i.e.
$$\gamma = \frac{\omega \phi_{max}}{2\pi K}$$

Now,
$$\left(\frac{d\alpha}{dt}\right)_{max} = 2\xi\omega_n v_{max}$$

Therefore,
$$\alpha_{max} = \int_0^{2\pi/\omega} 2\xi\omega_n v_{max} \cdot dt$$

$$= \frac{4\pi\xi\omega_n v_{max}}{\omega}$$

Let the v_{max} be the initial condition, which means the phase compensation or shifting has just started, $e_2 = 0$.

Then
$$\alpha_{max} = \phi_{max}$$

Substituting for $2\xi\omega_n$;

$$\gamma = \frac{v_{max}}{\tau} \quad \dots(34)$$

Thus, higher the value of τ , higher can be the value of v_{max} , i.e. even for higher values of v_{max} (i.e. α_{max}), cycle slipping will not occur.

6. Acquisition Time for the Second Order Loop

The acquisition time is defined as the time taken for the value α to change from its initial value α_{in} to a value where capture occurs. As discussed in the previous section, for values of α below α_{max} corresponding to the isocline representing $dv/d\alpha = 0$, cap-

ture occurs within one phase cycle. However, for values of v corresponding to values above α_{max} , the rate of decrease in v per phase cycle may be assumed to be a constant^{5,7} as

$$v(\alpha) = v_{in} + \cos \alpha - \beta\alpha ; \text{ for } -\frac{\pi}{2} < \alpha < +\frac{3\pi}{2},$$

where $\beta = \delta v/2\pi$ and δv is the decrease in v per cycle and v_{in} is the initial value of $dv/d\alpha$. Substituting this in Eq. (32)

$$\frac{dv}{d\alpha} = \frac{\cos \alpha}{4\xi^2[v_{in} + \cos \alpha - \beta\alpha]} - \sin \alpha \dots(35)$$

If $v_{in} \gg 1$ and $\beta \ll 1$, Eq. (35) may be rewritten⁷ as

$$\frac{dv}{d\alpha} = \frac{\cos \alpha}{4\xi^2 v_{in}} \left[1 - \frac{\cos \alpha - \beta\alpha}{v_{in}} \right] - \sin \alpha \dots(36)$$

Integrating, between the limits $-\pi/2$ to $+3\pi/2$;

$$\delta v = \frac{\pi}{4\xi^2 v_{in}^2} \dots(37)$$

Therefore, time per cycle is

$$\delta t \approx \frac{\pi}{2\xi\omega_n} \left[\frac{2}{v_{in}} \right] \dots(38)$$

From Eqs. (37) and (38)

$$t = \frac{4\xi}{\omega_n} \int_{v_0}^{v_{max}} v_{in} dv$$

or
$$t = \frac{2\xi}{\omega_n} [v_{max}^2 - v_0^2] \dots(39)$$

Now, substituting for v_0 and v_{max}

$$t = \frac{1}{2\xi\omega_n} \left[K_3^2 \left(\frac{de_2}{dt}\right)_{max}^2 - K_3^2 \left(\frac{de_2}{dt}\right)_0^2 \right] \dots(40)$$

From Eqs. (6) and (9)

$$\frac{d\phi_0}{dt} = \omega - K_3 \frac{de_2}{dt}$$

or
$$K_3 \frac{de_2}{dt} = (\omega - \omega_0) \dots(41)$$

where
$$\omega_0 = \frac{d\phi_0}{dt}$$

Also, within the normal working range of the Sanky phase shifter as a frequency modulator, maximum value in $K_3 \cdot de_2/dt$ brings the maximum frequency change⁸ which can only be $\pm \omega$ depending on the sign of $(de_2/dt)_{max}$.

Hence, Eq. (40) may be written as

$$t \approx \frac{1}{2\xi\omega_n^3} \left[\omega^2 - (\omega - \omega_0)^2 \right] \dots(42)$$

If we assume, initially $K_3 \cdot de_2/dt$ is very small, then $(\omega - \omega_0)$ may be neglected in comparison to ω . Therefore, Eq. (42) gives the maximum acquisition time as

$$t_{max} \approx \frac{\omega^2}{2\xi\omega_n^3} \quad \dots(43)$$

If the term $(\omega - \omega_0)$ is not neglected, then Eq. (42) yields

$$\omega_0^2 - 2\omega\omega_0 + 2\xi\omega_n^3 t = 0 \quad \dots(44)$$

Solving Eq. (44) for ω_0 , we get

$$\omega_0 = \omega \pm \omega \sqrt{1 - \frac{2\xi\omega_n^3}{\omega^2} \cdot t} \quad \dots(45)$$

Since from Eq. (41), $(\omega - \omega_0) = d\alpha/dt$,

$$\text{Hence } \frac{d\alpha}{dt} = \mp \omega \sqrt{1 - \frac{2\xi\omega_n^3}{\omega^2} \cdot t}$$

If it is assumed, that initially when the phase shifting starts, the value of e_2 is zero, and when α reaches α_{max} , the locking occurs, then, $\alpha(\text{initial}) = \phi$ and $\alpha(\text{final}) = \alpha_{max}$:

$$\text{Therefore, } \int_{\phi}^{\alpha_{max}} d\alpha = \mp \omega \int_0^{t_0} \sqrt{1 - \frac{2\xi\omega_n^3}{\omega^2} \cdot t} \cdot dt$$

$$\text{or, } (\alpha_{max} - \phi) = \frac{\omega^3}{3\xi\omega_n^3} \left\{ 1 - \frac{2\xi\omega_n^3}{\omega^2} \cdot t_0 \right\}^{3/2} - \frac{\omega^3}{3\xi\omega_n^3}$$

rearranging and from Eq. (43)

$$t_0 = t_{max} \left\{ 1 - \left[(\alpha_{max} - \phi) \frac{3\xi\omega_n^3}{\omega^3} + 1 \right]^{2/3} \right\} \quad \dots(46)$$

From Figs. (7) to (10) it can be seen that α_{max} corresponds to ν_{max} . If ϕ corresponds to α_{max} , then t_0 becomes 0, in Eq. (46), which shows capture occurs within one phase cycle as discussed.

$$\text{or, } t_0 = \frac{\omega^2 \tau^3}{K^2} \left\{ 1 - \left[(\alpha_{max} - \phi) \frac{3K^2}{2\tau^3\omega^3} + 1 \right]^{2/3} \right\} \quad \dots(47)$$

In order to have t_0 real and positive,

$\left[(\alpha_{max} - \phi) \frac{3K^2}{2\tau^3\omega^3} + 1 \right]$ has to be positive and less than or equal to 1, i.e.

$$\phi_{min} = \alpha_{max}$$

$$\text{and } \phi_{max} = \alpha_{max} + \frac{2\tau^3\omega^3}{3K^2}$$

Therefore, the range of ϕ within which locking may occur is given by

$$\Delta\phi = \phi_{max} - \phi_{min}$$

$$\text{i.e., } \Delta\phi = \frac{2\tau^3\omega^3}{3K^2} \quad \dots(48)$$

Acknowledgement

The author wishes to thank Dr P. K. Iyengar, Director, Physics Group, Bhabha Atomic Research Centre, Bombay, for his keen interest and guidance in this work. His thanks are also due to Dr S. Z. Qasim, Director of the Institute for providing facilities and encouragement to carry out this study.

References

1. SANKARANARAYANAN, P. E., *Int. J. Electron.*, 35 (1973), 745.
2. SANKARANARAYANAN, P. E., *Int. J. Electron.*, 36 (1974), 35.
3. SANKARANARAYANAN, P. E., *Electron. Technol.*, 1973, 171.
4. JAFFE, R. M. & RECHTIN, E., *IRE Trans. (Information Theory)*, IT 1 (1955), 66.
5. VITERBI, A. J., *Active networks and feedback systems* Vol. 10 (Polytechnic Press, Inc., New York), 1960.
6. FLOYD GARDENER, M., *Phase lock techniques* (John Wiley & Sons Ltd, London), 1965.
7. SRINIVASA RAGHAVAN, H. R. & SANKARANARAYANAN, P. E., *Int. J. Electron.*, 32 (1972), 261.
8. SANKARANARAYANAN, P. E., *Electron. Technol.*, 1974, (in press).
9. SANKARANARAYANAN, P. E., *Proceedings of the seminar on electronic measurements and instrumentation* (Institution of Electronic and Telecommunication Engineers, Bangalore), 1975, (in press).