

MODEL STUDIES ON TETHERED FLOAT BREAKWATER SYSTEM

J. S. SASTRY
Head
Physical Oceanography Div.
National Institute of
Oceanography
Dona Paula, Goa 403 004.

S. NARASIMHAN
Professor
Dept. of Civil Engg.
Indian Institute of
Technology
Powai, Bombay 400076.

P. VETHAMONY
Scientist
P. O. D.
NIO
Dona Paula,
Goa 403 004

ABSTRACT

Experiments on a physical model of a portable Tethered Float Breakwater (TFB) system were conducted in the wave flume to study the performance of the system for various combinations of wave heights and periods and for different freeboards, the tether length being kept constant. Configuration, fabrication and installation of the model are briefly explained. With the present system, a maximum of 64 per cent wave reduction was achieved. Experiments indicated that TFB provides effective wave reduction when the buoys were tethered just below the still water level. The wave reduction efficacy is closely related to wave frequency and the lowest transmission coefficient was found to be at the resonant frequency of the float for any wave height. Wide potential applications are envisaged, in particular, where short term wave attenuation is needed.

INTRODUCTION

The concept of portable floating breakwaters has generated great interest in the field of Ocean Engineering in the past few decades since floating breakwaters are less expensive compared to conventional type breakwaters founded on the ocean bottom. As it allows easy expansion of existing harbour facilities, it could be utilised to meet location changes, extent of protection required or seasonal demand. They can be used as a temporary protection to offshore activities in hostile environments while construction, drilling works, salvage operations or loading/unloading petroleum products are progressing. Almost all the floating breakwaters are based on concepts either reflecting wave energy or dissipating wave energy by induced turbulent motion. Tethered float breakwater (TFB) belongs to the second category in which wave energy dissipation is mainly due to drag from the resultant buoy motion. This system was

first proposed by Professor John Isaac of the Scripps Institution of Oceanography. Laboratory evaluation was conducted by Dr. Seymour at Scripps (Essoglou, 1975). A mathematical model has been derived by Seymour (1974) to predict the attenuation of a particular array configuration on a given incident wave spectrum. The physical model of the system developed has been tested in the regular waves to understand the performance of the system for various combinations of wave heights and periods.

MECHANISM OF WAVE REDUCTION BY TFB

The TFB system is made up of a large number of arrays of independently tethered spherical buoys (Fig. 1) submerged just below the water surface. The size of each buoy is small compared to the wavelength, but may be of the size of expected wave height. The system is highly damped by the resistance to motion. One component of this resistance is inertial and in phase with the acceleration. The second component, the drag produced during the rapid and vigorous oscillations of the tethered buoyant floats, is in phase with the relative velocity and is dissipative. This is argued to be the main contributing factor in wave energy attenuation (Seymour, 1976). Also, the dissipative power of the system is proportional to the cube of the relative velocity between the floats and the particle velocity of the fluid (Seymour, 1976). For a particular tether length, relative velocity can be increased by proper choice of floats of low specific gravity compared to water. In the present study, floats with specific gravity of 0.203 were employed. The float is tethered and is kept just below the water surface so that it remains in the high pressure gradient field. The tethered float behaves as an oscillator driven by the volume forces of the waves. It is found from the present study that the effective wave reduction is maximum (or transmission coefficient is minimum) when the natural frequency of the system coincides with the wave frequency. In field, 'wave frequency' to be considered is the frequency corresponding to the peak energy in the wave spectrum.

WAVE FLUME AND WAVE MEASUREMENT

The wave flume available at IIT Bombay is a large RCC channel 50 m long, 2 m wide and 2 m deep. It has two observation panels made up of glass plates on one side of the flume. At one end of the flume a wave generator has been installed. Regular waves can be generated by a flap type paddle. This paddle is activated by two adjustable arms, and the desired wave amplitude can be obtained by adjusting the eccentricity of arms. In order to reduce wavereflection from the far end, wave absorbers are used. At the far end of the flume, a beach with a conventional parabolic profile is constructed. The paddle stroke can be varied to generate waves of heights between 6 cm and 40 cm for a given water depth and wave period. The possible wave periods that can be generated are between 1 sec. and 6 sec. The layout of the wave flume is shown in Fig. 2.

The wave measuring unit is a system manufactured by Churchill Controls, U.K. The probe consists of a pair of stainless steel wires of 1.5 mm in diameter and spaced 12.5 mm apart. The wires dip into the water and the current that flows between them is proportional to the depth of immersion. The current is sensed by an electronic circuit which provides an output voltage proportional to the instantaneous depth of immersion, i.e. wave height. The profile can be recorded on a strip chart recorder. Before actual observations were taken, the output voltage was calibrated in terms of wave height by varying the depth of immersions of the probe in still water by a measured amount. The wave measuring unit assembly is shown in Fig. 3.

MODEL SET-UP FOR EXPERIMENTS

Spherical buoys made of polyvinyl chloride (PVC) with the following specifications were employed.

outer diameter = 20 cm; wall thickness = 0.75 cm
mass = 850 gm; specific gravity = 0.203

Throughout the experiment the tether length (=100 cm) was kept constant. The buoys were tethered to a frame resting on the bottom. In the first trial, only eleven rows of floats, four or three floats placed in alternate rows was tested (Fig. 4a). The typical results of the experiment are tabulated (Table 1). It is seen from the table that, for all water depths, the transmission coefficient (C_t = transmitted wave height / incident wave height) is relatively high or in other words wave height attenuation is low. The experimental results were examined critically and it was felt that a substantial reduction in wave height could be obtained by increasing the number of rows of buoys and the number of floats in each row which also decreased the gap between end buoys and the flume wall.

In the second experiment, buoys of the same size ($D=20$ cm) were arranged in 22 rows with 5 and 4 buoys placed alternately in each row. Thus, the beam of IFB model was increased from 4.0 m to 8.4 m. Model configuration is shown in Fig. 4b. With the second experimental set-up, tests were performed for four freeboards (10.0, 5.0, 1.5 and -10.0 cm - height of still water level above the top of float). When the water depth was 120 cm, the floats were colliding with each other and the breakwater system was not fully effective and the results have not been considered.

RESULTS AND DISCUSSION

Experiments were conducted for different wave periods ranging between 2 and 5 sec and incident wave heights varying from 10 to 31 cm. Typical wave profiles of incident and transmitted waves are shown in Fig. 5. A few values of wave periods (T), incident and transmitted wave heights (H_i and H_t), transmission coefficients (C_t) and steepness (S) for the three

water depths considered (131.5, 135.0 and 140.0 cm) are given in Table 2. Transmission coefficient varies between 0.36 and 0.90, which shows that the maximum wave height reduction that could be obtained with the present model configuration and a particular combination of wave height and period is approximately 64 percent.

Transmitted wave height (H_t) is a function of incident wave height (H_1), wave length (L), water depths (d), free board (h), diameter of the float (D), specific gravity of the float (ρ_s), lateral and longitudinal spacings between the floats (S_1 and S_2), deflection rate of the tether (R =load/deflection), beam of the model (B), natural frequencies of the tether and the system (f_t and f_n), density of sea water (ρ), gravitational acceleration (g) etc. It may be noted the spring characteristic R determines the frequency f_t of the tether system in the vertical direction and f_n the longitudinal frequency of oscillation is controlled by the tether length ($d-h-D$) i.e.

$$H_t = f(H_1, L, d, h \text{ or } f_t, D, \rho_s, S_1, S_2, R \text{ or } f_n, B, \rho, g, \dots)$$

By dimensional analysis we get,

$$\frac{H_t}{H_1} = \phi\left(\frac{H_1}{L}, \frac{d}{H_1}, \frac{D}{H_1}, \frac{\rho_s}{\rho}, \frac{S_1}{D}, \frac{S_2}{D}, \frac{R}{\rho g H_1^2} \text{ or } \frac{f_n}{\sqrt{g/L}}, \frac{B}{L}, \frac{h}{H_1} \text{ or } \frac{f_t}{\sqrt{g/L}} \dots\right)$$

Transmission coefficient ($C_t = H_t/H_1$) is always less than unity. Lower the transmission coefficient, higher the wave height attenuation.

Larger the steepness values (H_1/L) greater will be the effectiveness of the breakwater. It is observed that low waves pass through the breakwater without any attenuation. For high waves also the system is less effective and there is an optimum wave height limit upto which the breakwater is effective in wave height reduction. Hence, H_1 is an important parameter to be considered while designing the breakwater. Plots of steepness versus transmission coefficient are shown in Fig. 6. The results show such a wide scatter that no definite relationship can be established between C_t and S . The reason may be that the waves generated are long period and there was difficulty in generating short period waves in the flume. Lower the values of d/H_1 , greater will be the effectiveness (C_t will be lower). d/H_1 gives the shallow water effect and wave breaking condition. To study this, tether length should be varied in accordance with the water level change. In this particular work, this aspect has not been studied. h/H_1 has an optimum value. From Table 2, it is clear that for maximum wave height attenuation freeboard should be less, i.e floats should be slightly submerged. As freeboard increases, effective mass (actual mass + added mass of entrained fluid) of the float increases upto a certain freeboard)

but decreases its response to the wave driving force and in effect wave height attenuation will be less. It is expected that performance improves with increasing diameter and hence higher values of D/H_1 are advocated. But, as volume of the float increases, its cost and handling and erection charges also increase rapidly and hence optimum size should be established to minimize costs. Seymour (1974) suggested that reasonable diameter for the floats will be of the same order as the significant wave height. It has been proposed that experiments have to be conducted with buoys of different sizes in future.

Smaller the S_1/D or S_2/D , lower will be C_t . S_1 or S_2 should be taken in such a way that the buoys should not collide with each other. In the present experiment, S_1 and S_2 are kept nearly the same ($S_1=D$ and S_2 is slightly greater than D). If S_1 or S_2 is small, number of floats required will be more and accordingly cost will be higher. It appears reasonable that spacings between floats may be of one clear diameter in all directions. Lower the ρ_s/ρ values, lesser will be C_t . This can be achieved by employing buoys of very low specific gravity compared to seawater. In the present study, $\rho_s = 0.203$. For effective wave reduction ρ_s should be still less. It is proposed to conduct experiments with the procured low specific gravity buoys (Aluminium) to assess the effect of specific gravity in wave energy attenuation. Another important parameter is the tether spring characteristic, $R = \text{load (P)}/\text{deflection (e)}$. Hence for a constant load, R will be less if deflection is greater. When deflection increases, turbulence also increases and greater will be the wave height attenuation. Therefore, lower the $R/\rho g H_1^2$ values, lesser will be C_t . This aspect will be covered in the next stage of the experiment (Spring tether system). Higher the B/L ratio, greater will be the wave height attenuation. B is the factor which decides the level of wave attenuation required. For effective wave reduction, beam of the model should be at least one wave length. This is clear from the low C_t values obtained when the beam is increased from 4.0 m to 8.4m.

The results show that for a given incident wave height, wave height reduction is maximum at a particular frequency. This wave frequency corresponds to the natural frequency of the floats. Natural period (T_n) and frequency (f_n) of the floats and wave period (T_w) and frequency (F_w) corresponding to minimum C_t are tabulated (Table 3). Tethered float may be considered as an inverted simple pendulum. It is seen from Table 3 that natural frequency of oscillation of the floats increases with increase in freeboard. When the floats are under motion due to waves, the effective mass of the float increases and thereby decreases the natural frequency. Hence, resonance occurs at a lower frequency than the natural frequency found under still water conditions. This may be the reason for obtaining minimum C_t for wave frequencies lesser than the natural frequency. Here lies the significance of tether length, specific gravity of the floats and freeboard. Natural frequency of the elastic tether is not assessed separately as a fixed tether length was used in the

present experiments, f_t also has to be reassessed when spring-tether-float system is employed.

CONCLUSIONS

When the beam of the model was increased from 4.0 m to 8.4 m, wave reduction increased appreciably. Hence, for effective wave reduction the beam may be of the order of one wave length. No definite relationship has been established between steepness and transmission coefficient in the case of IFB as the experimental scatter is wide. The maximum reduction in wave height is found to be at the resonance and resonant frequency is slightly lesser than the natural frequency of the floats found under the still water conditions. The contribution of many parameters in wave height attenuation has yet to be determined.

The experiments were performed in regular waves. However, field condition necessitates to evaluate the transmission coefficient in random waves. The length of the model (1.6 m) is slightly smaller compared to its beam. However, length of breakwater may be chosen depending on the width of waveshadow required.

It is proposed to study the performance of the system with different sizes and lower specific gravity buoys (say, aluminium). It is also proposed to conduct experiments with spring connected tethers so as to provide greater freedom for the motion of the floats in the vertical direction for creating greater turbulence and thereby achieve higher wave energy reduction.

Being spherical in shape and individually tethered, the response of the system is similar in all directions of wave approach. Several modules can be fabricated near the site and can be towed to the desired location and deployed. When the purpose is accomplished they can be retrieved for servicing and maintenance. Low installation costs appear attractive for very short term construction projects where high seastate prevails. Since waves along east and west coasts of India are seasonally changing in nature, mainly in accordance with the southwest and northeast monsoons, tethered float breakwater appears to be a promising system to create wave shadow, wherever short term protection is required.

ACKNOWLEDGEMENTS

The authors wish to express their deep gratitude to the Director of NIO, Goa, for his keen interest in the above studies and for providing facilities to carry out the work. The help of Shri Mahesh Shah (former graduate student) and all the laboratory technicians of IIT are gratefully acknowledged. They also extend their thanks to the Salt Commissioner, Government of India, for providing funds to carry out this project work.

REFERENCES

- Essoglou, M.E., Seymour, D.R.J. and Berkley, J.B. (1975).
 IFB : A transportable Open Ocean Breakwater. IEEE
 Oceans '75. pp. 723-725.
- Seymour, R.J. and Isaacs, J.D. (1974). Tethered Float Breakwaters.
 Proc. of Floating Breakwater Conf., Rhode Island, April
 1974. pp. 55-72.
- Seymour, R.J. (1976). Tethered Float Breakwater : A Temporary
 Wave Protection System for Open Ocean Construction.
 Offshore Technology Conference, Paper No. OTC 2545,
 pp. 253-264.

...

Table 1 : Results of Experiment No. 1
 (Eleven rows with 4 and 3 floats in alternate rows -
 staggered arrangement)

Water level (cm)	Wave heights(cm)		Transmission coefficient C_t
	Incident (H_i)	Transmitted (H_t)	
125	19	17	0.90
135	25	18	0.72
145	22	19	0.86

Table 2 : Results of Experiment No. 2

(22 rows with 5 and 4 floats in alternate rows - staggered arrangement)

Water level, cm	T sec	H _i cm ⁱ	H _t cm ^t	$C_t = H_t / H_i$	S
131.5	2.06	30.69	15.41	0.50	0.0509
	2.26	27.28	13.33	0.49	0.0377
	2.40	27.28	10.08	0.37	0.0334
	2.64	23.87	14.58	0.61	0.0242
	2.69	23.87	16.24	0.68	0.0233
	3.17	18.41	11.25	0.61	0.0031
135.0	2.15	25.00	15.00	0.60	0.0396
	2.28	25.00	19.50	0.78	0.0304
	2.40	21.87	12.50	0.57	0.0297
	2.56	23.13	11.25	0.49	0.0289
	2.83	23.00	13.00	0.57	0.0252
	2.90	15.71	11.87	0.76	0.0167
140.0	3.00	16.87	12.50	0.74	0.0172
	2.12	22.00	12.53	0.57	0.0353
	2.35	22.00	14.00	0.64	0.0306
	2.39	21.33	13.00	0.61	0.0287
	2.51	23.33	11.33	0.49	0.0295
	2.59	19.00	14.00	0.74	0.0231
	2.94	16.00	14.00	0.88	0.0165
3.14	16.67	11.67	0.70	0.0158	

Table 3 : Natural Frequency of Floats and Wave Frequency at minimum C_t

Water level cm	T _n sec	F _n H _z	T _w sec	F _w H _z
131.5	2.22	0.4505	2.40	0.4167
135.0	2.09	0.4785	2.56	0.3906
140.0	1.97	0.5076	2.51	0.3984

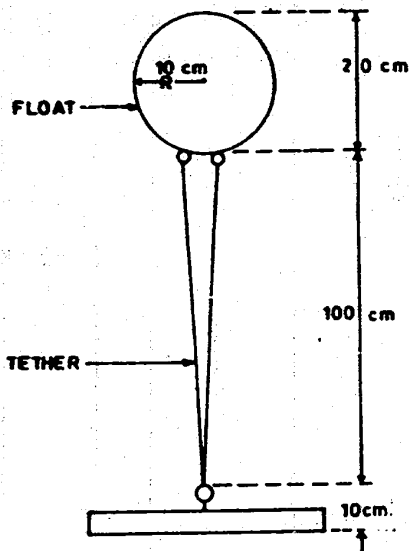

FIG. 1 TETHERED BUOY CONFIGURATION

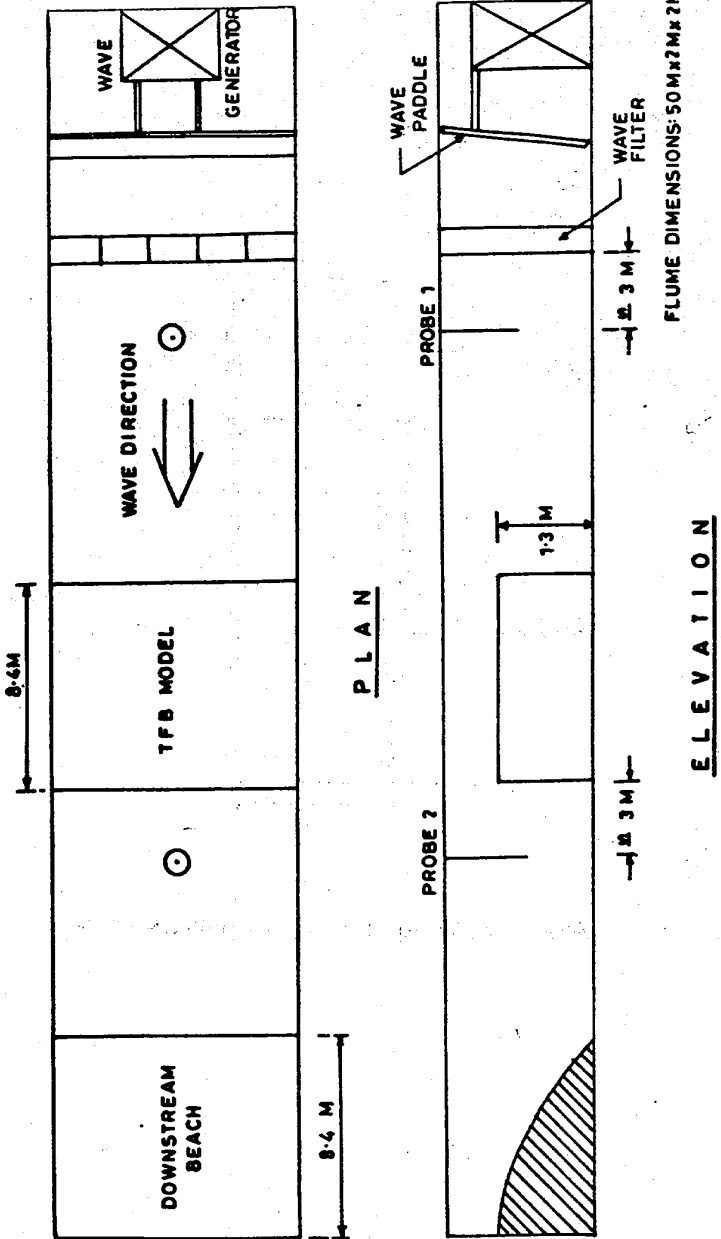

FIG. 2 THE WAVE FLUME AND GENERAL LAYOUT

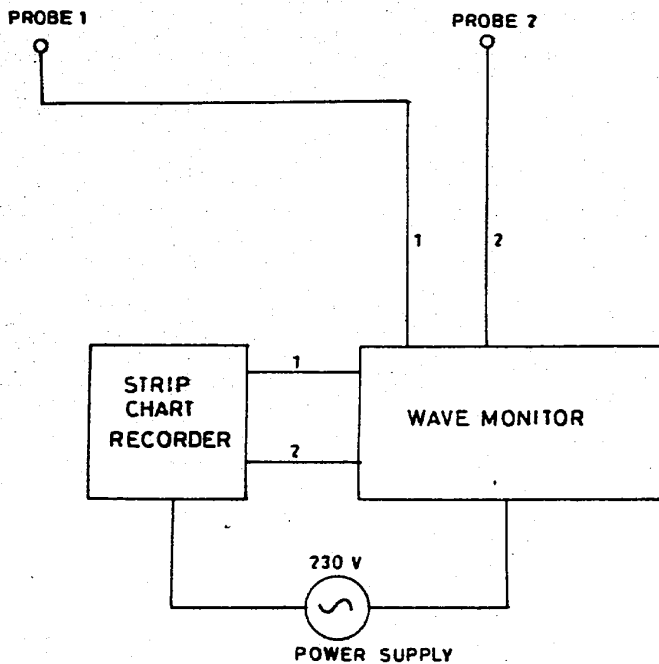
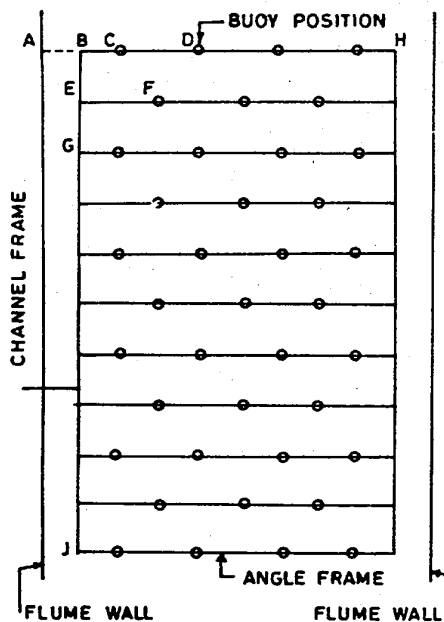
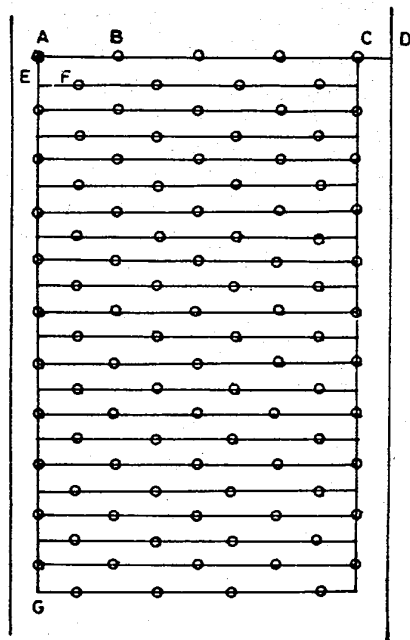

FIG. 3 INSTRUMENT ASSEMBLY



AB = 20 cm BC = 20 cm
 CD = 40 cm EF = 40 cm
 BE = 40 cm EG = 40 cm
 BH = 160 cm BJ = 400 cm
 NO. OF ROWS = 11 NO. OF BUOYS = 39

FIG. 4a. MODEL SET-UP FOR EXPERIMENT NO.1



AB = 40 cm CD = 20 cm
 AE = 40 cm EF = 20 cm
 AC = 160 cm AG = 840 cm
 NO. OF ROWS = 22
 NO. OF BUOYS = 99

FIG. 4b. MODEL SET-UP FOR EXPERIMENT NO.2

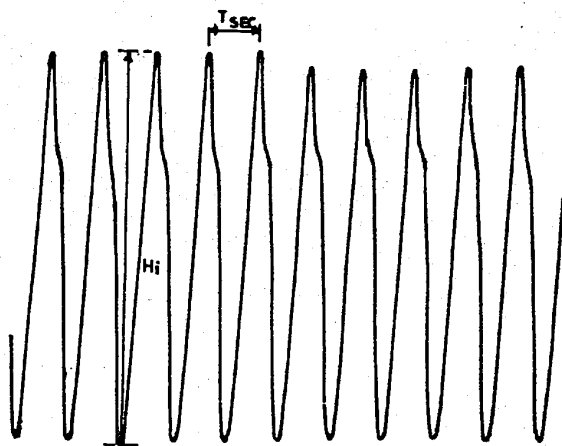

INCIDENT WAVE PROFILE

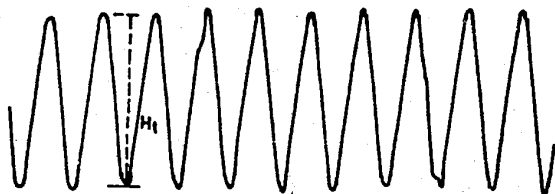

TRANSMITTED WAVE PROFILE

TIME AXIS : 1 cm = 2.36 Sec.

HEIGHT AXIS : 1 cm = 2.917 cm.

FIG. 5 SAMPLE WAVE RECORD

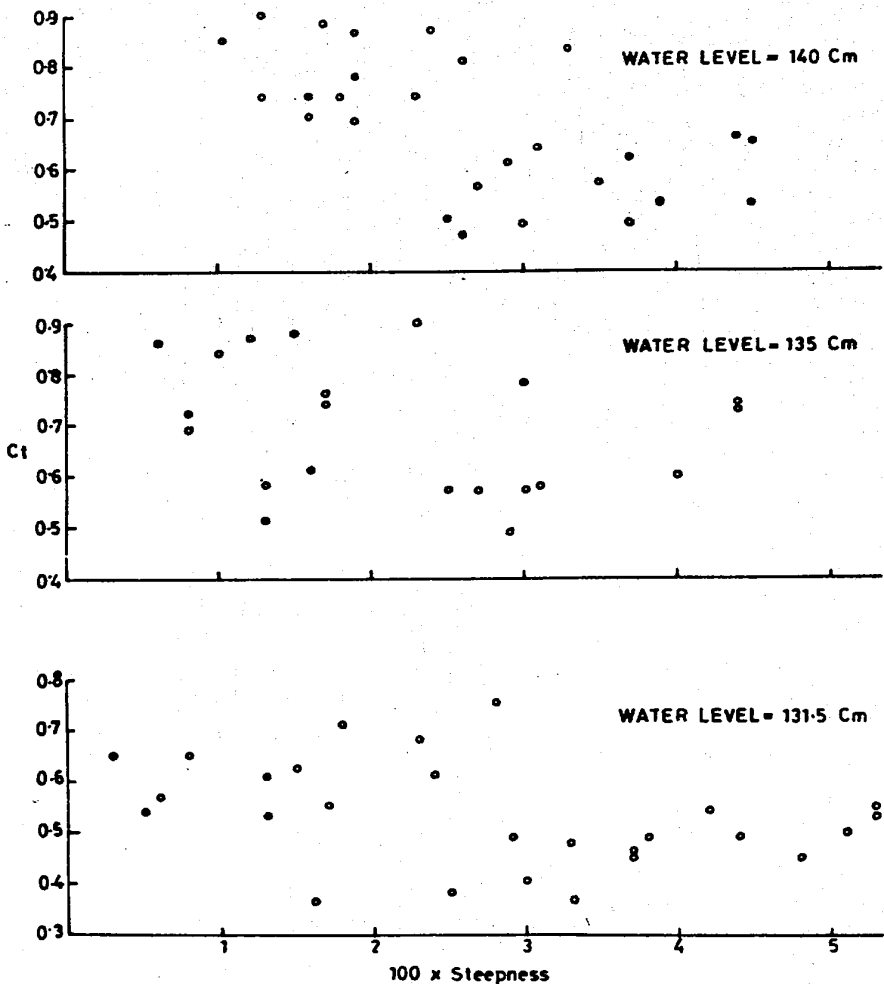

FIG. 6 SCATTER DIAGRAM OF STEEPNESS VS TRANSMISSION COEFFICIENT