

Temperature Measurement in the Sea*

R J Krishnamacharyulu & L V Gangadhara Rao
National Institute of Oceanography, Dona Paula, Goa 403004, India

The importance of measuring sea temperature is explained and the various methods employed for this purpose are reviewed. Instruments used for spot measurement of water temperature at the sea surface and at discrete depths (bucket thermometer, reversing thermometers, T.S. bridge), recording of temperature variation with depth or temperature—depth profile (bathy-thermographs), recording of temperature variation near the sea surface and at different (fixed) depths (thermographs, recording current meters with temperature sensors, moored data buoys and drifting buoys) are described in brief. Specialised equipment used for studying oceanic features like internal waves, thermal fronts and temperature microstructure (thermistor chain, isotherm follower, C/STD systems and Batfish) are also described. Upper ocean temperature measurements carried out recently in the Indian Ocean, using a thermistor chain from an Indian research ship for the first time, are described and the relevant data processing and analysis are presented. Sea surface temperature measurement by infrared and microwave remote sensing techniques (shipborne/airborne precision radiation thermometers, spaceborne very high resolution infrared radiometers, microwave radiometers), their advantages and limitations are also touched upon. Calibration of various instruments used for temperature measurement in the sea and the special set-up/facilities needed for this purpose are also discussed.

The oceans constitute a large reservoir of heat. The temperature of land surface may vary over a wide range. In contrast, the sea surface temperature (SST) is unlikely to vary more than ten degrees with the season or more than one degree between day and night. The SST reaches maximum value at about two o'clock in the afternoon and the minimum value at about five o'clock in the morning. The oceanic temperature distribution varies greatly in space as well as time. Temperature changes at the surface or at various depths may be caused by several factors, such as (i) radiation from the sun, (ii) mixing by the wind, (iii) advection of water of a different temperature, (iv) tidal currents, or (v) internal waves. Variations of temperature in space are

notably modified by ocean currents. For example, comparatively warm water in the course of Gulf stream prevails far in the northern Atlantic and cold water is encountered in the path of the Humbolt (or Peru) current very close to the equator in the eastern part of the Pacific Ocean. Vertical temperature distribution along a longitudinal section through the western Indian Ocean¹ is shown in Fig. 1.

Sea temperature is a primary oceanic parameter and its measurement is of utmost importance in oceanographic studies. Spatial variations in temperature can be related to the properties of water masses and their boundaries. The horizontal boundaries exhibit relatively abrupt temperature changes and represent thermal fronts separating unlike watermasses. It is possible to trace movements of water masses

*Paper presented at the national seminar on Temperature Measurement, NPL, New Delhi, 26-28 February 1985.

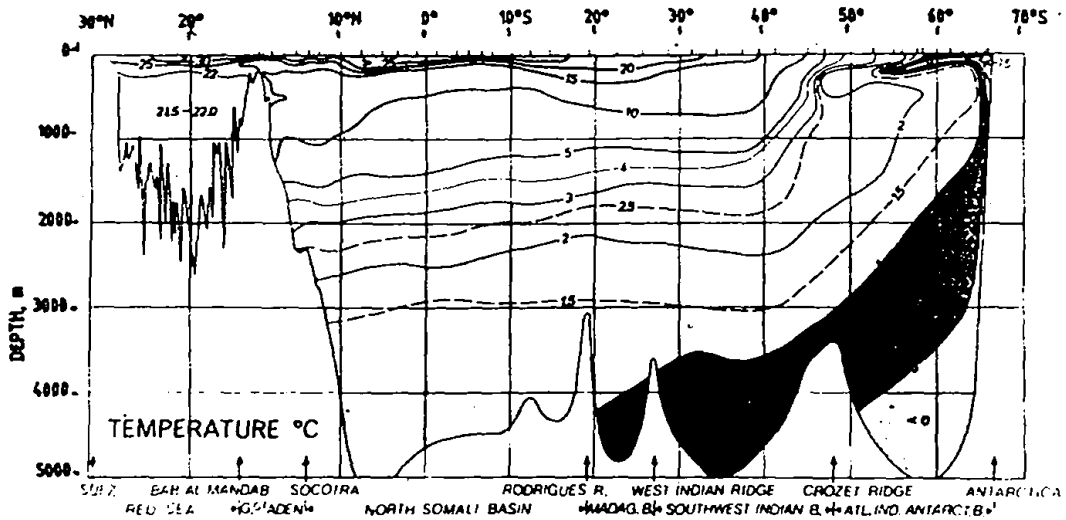

Fig. 1—Vertical distribution of temperature along longitudinal section through the Indian Ocean on the western side. (Based on Wyrtki, 1971)

partially on the basis of temperature differences, and for this purpose we must measure very small differences in temperature with good accuracy (not less than one-tenth of a degree centigrade).

For an accurate indirect computation of salinity (which is another important oceanic parameter) from the measured value of electrical conductivity, we use the relation:

$$S = f(C, T, D)$$

where f is an algebraic function of conductivity, temperature and depth. Similarly, for indirect computation of sea water specific volume and density (needed for deducing the field of mass and thereby the geostrophic currents in the sea) we require accurate sea temperature in addition to salinity. Sound velocity in the sea governs the underwater propagation (transmission and reception) of sound waves, which has vital application in the navigational ranging, acoustic tomography, etc. Sound velocity in the sea can be computed indirectly by the use of the relation:

$$V = \varphi(S, T, D)$$

where φ is an algebraic function of salinity, temperature and depth. At 0°C, the speed of sound is 1449.3 m/sec for a salinity of 35 ppt at

atmospheric pressure and increases by about 4.5 m/sec per 1°C increase in temperature, 1.4 m/sec per 1 ppt increase in salinity and 0.016 m/sec per 1 metre increase in depth (1 atmosphere \approx 10 metres)². Thus the speed of sound in the sea is influenced by temperature to a large extent and hence the measurement of temperature in the sea assumes special significance.

Temperature is an important physical environmental parameter influencing the biological productivity in the sea. Temperature directly influences the rate of development of fish eggs in the sea. The body temperature of most fish differs from that of the surrounding water not more than 1°C and most fish species prefer specific temperature ranges. A thorough knowledge of the temperature distribution in the sea and its seasonal variation helps us in assessing the seasonal abundance of certain species of catchable fish stocks. Thus the measurement of sea temperature is important for the exploration of marine living resources also.

Four types of temperature measuring device are used in oceanography. Accurate thermometers of the standard type are employed for measuring sea surface temperature. A special type of

TEMPERATURE MEASUREMENT IN THE SEA

mercury-in-glass thermometers, called the reversing thermometers, are used for measuring temperature at sub-surface levels. Another type of temperature measuring instruments give continuous record of temperature against depth, such as bathythermographs. The fourth type are the temperature measuring instruments that give a continuous record of temperature against time, such as thermographs. These are employed as moored instruments on board research vessels to record the temperature at fixed levels or near the sea surface.

Temperature measurement at discrete depths

(i) *Bucket thermometer*—This is used to measure sea surface temperature. It consists of a specially designed rugged container (bucket) made up of corrosion-resistant material, holding a standard mercury-in-glass thermometer inside with rubber cushioning for protection. Thermometers with a range of -2° to $+40^{\circ}\text{C}$ and subdivisions of 0.2°C or 0.1°C are normally used for this purpose and are read to the nearest 0.1°C .

(ii) *Reversing thermometers*—These are the mercury-in-glass thermometers specially designed for recording water temperature accurately at any desired depth below the surface, by being reversed there. These are generally mounted on water sampling devices, such as Nansen bottles (1.2 to 2 litres) and Niskin bottles (1.7 to 30 litres), which are used for obtaining water samples from different depths.

There are two types of deep sea reversing thermometers, the protected and unprotected (Fig. 2). Protected reversing thermometers, enclosed in heavy glass jacket, can record true reading of the water temperature without being affected by external hydrostatic pressure. Unprotected reversing thermometers, enclosed in heavy glass jackets with one end open, record readings concerning both water temperature and hydrostatic pressure by being in direct contact with water. An unprotected thermometer when used with a protected thermometer (both

mounted on a water sampling bottle) enables us to calculate the exact depth from where the water sample was collected.

A reversing thermometer consists of two parts, namely, a reversing MAIN thermometer and an ordinary AUXILIARY thermometer. The auxiliary thermometer is used to obtain the correction to be applied to the main thermometer reading for thermal expansion of the thermometer system subsequent to reversal. Besides the correction for thermal expansion, an index correction for errors in the thermometer scale has also to be applied to the main thermometer reading. Usually, the main thermometer is read to 0.01°C and the auxiliary thermometer is read to 0.1°C . After corrections for thermal expansion

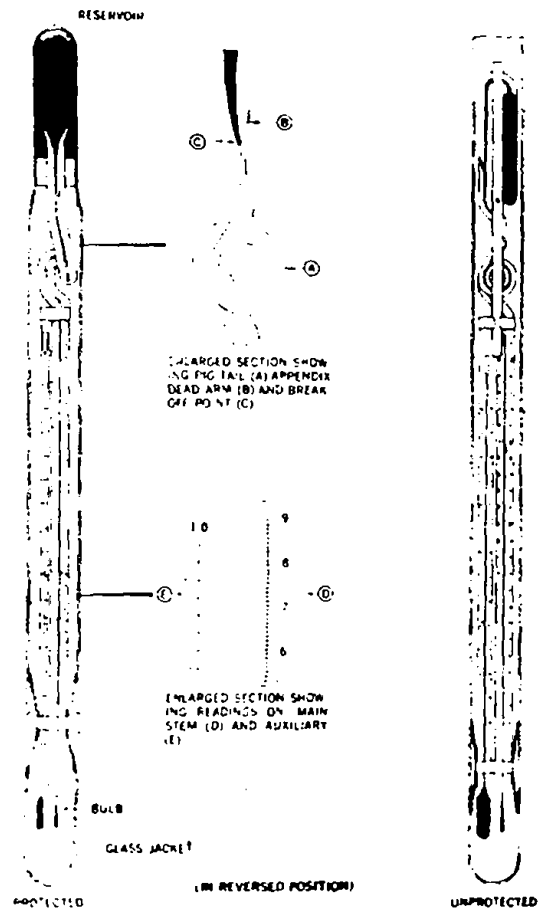

Fig. 2—Protected and Unprotected Deep-Sea Reversing Thermometers

TEMPERATURE MEASUREMENT IN THE SEA

be read on the deck unit. Normally the following ranges are available:

Temperature	: 0° to 40°C (accuracy $\pm 0.5^\circ\text{C}$)
Conductivity	: 0 to 60 mmho/cm (accuracy ± 0.5 mmho/cm)
Salinity	: 0 to 40 ppt (accuracy ± 0.3 ppt)

The T.S. Bridge is very useful for observations in the nearshore waters and estuaries.

Temperature-depth profile measurement

(i) *Mechanical bathythermograph (MBT)*—This is a widely used instrument to obtain continuous record of temperature against depth (Fig. 4). In this instrument a liquid-in-metal thermometer (capillary tube filled with xylene driving a Bourdon tube) causes a metal point (stylus) to move in one direction over a smoked/gold-coated glass slide which is itself moved at right angles to this direction by a pressure sensitive copper bellows (slyphon). This torpedo-shaped instrument is lowered into the sea from a vessel to its specified depth limit and then brought back onto the deck. Since pressure is directly related to depth, the line scratched on the smoked glass slide forms a graph of temperature against depth. The glass slide with the trace is superimposed on a pre-calibrated grid to read the temperature at different depths. This instrument can be used from a ship moving at speeds up to 12 knots.

Typical specifications:

Depth range	: 0 to 60m, 0 to 140m, 0 to 275m; Accuracy: ± 2 m
Temperature range	: -2° to $+32^\circ\text{C}$; Accuracy: $\pm 0.2^\circ\text{C}$

(ii) *Expendable bathythermograph (XBT)*—Expendable bathythermograph system is specially designed for use in any sea state and while the ship is underway at speeds up to 30 knots. It employs an advanced technique for continuous

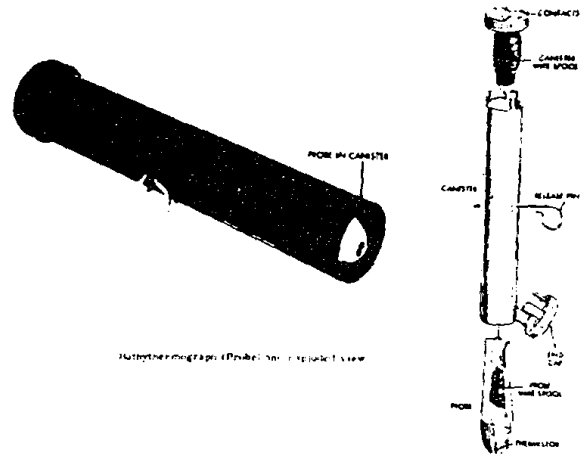

Fig. 5—Expendable Bathythermograph Probe and its Exploded View

measurement and recording of ocean temperatures against depth. It consists of an expendable probe, a launcher and a recorder. The probe is small, streamlined and hydrodynamically smooth and contains a thermistor connected to two spools of fine twin-bonded pair of thin copper wires, one in the nose part of the probe and the other in the probe canister (Fig. 5). When the probe is launched from a deck-mounted or hand-held launcher, the wire from both spools is free to unwind, allowing the probe to fall out at known sink rate without being affected by the forward motion of the ship. The nose of the probe which contains the thermistor is weighed and the housing is finned to ensure stability of downward motion. Loading the probe into launcher and closing the breech handle automatically makes electrical connection between the probe and recorder. The pins of the launcher are embedded in the metal of the canister contacts which are, in turn, sealed in protective compound (soft jelly) to ensure water-proof connections when the breech handle is closed. When the probe touches water the sea electrode is grounded and the recorder starts. In the recorder, the bridge circuits convert the thermistor resistance into voltage, which is recorded on the strip chart. All changes in the

thermistor resistance due to temperature change are traced on the horizontal scale of the strip chart recorder. Since the rate of descent of the probe is known, depth is recorded directly on the time axis of the chart. A test canister is often used to calibrate the system before use.

Typical specifications:

Depth range	: 0 to 460 m, 0 to 760 m, 0 to 1830 m; Accuracy: $\pm 2\%$ of depth range
Temperature range	: -2° to $+35^{\circ}\text{C}$; Accuracy: $\pm 0.2^{\circ}\text{C}$
Measuring cycle time	: 90 sec (for 0 to 460 m range)

Airborne XBT (AXBT) and Fine Structure XBT (FSXBT) are also available for deployment from aircraft and for fine structure studies respectively. Expendable CTD (XCTD) system, using thermistor as temperature sensing element has also been developed recently. Sippicon Corporation, USA, is manufacturing all types of XBT systems and XCTD systems. The Electronics Corporation of India Limited (ECIL) has also started manufacturing XBT system and probes of 460 m depth range⁴.

Continuous temperature recording at discrete depths

(i) *Thermosalinograph*—Continuous measurement of sea surface temperature and salinity along the ship's track is possible by means of thermosalinograph, wherein sea water is continuously pumped and passed through a temperature sensor and a conductivity sensor⁵. This system consists of a recorder and control unit electrically connected to a temperature sensor and a conductivity sensor. The temperature transducer is a compensated thermistor probe fitted suitably into the supply line of sea water. Filtered, bubble-free sea water through an air separator is supplied to the conductivity sensor, wherein salinity is deduced by inductively sensing sea water conductivity

and applying automatic compensation for temperature. The system records automatically after being turned on and set to the ranges for the temperature and salinity of the geographic area being investigated. Ranges overlap, permitting them to be changed without painstaking scrutiny of the plotter pen positions. Time and position notations are placed on the chart by the operator for correlating temperature and salinity data with geographic locations.

Typical specifications:

Temperature range	: -2° to $+36^{\circ}\text{C}$ in different subranges; Accuracy: $\pm 0.1^{\circ}\text{C}$
Salinity range	: 20 to 38 ppt in different subranges; Accuracy: ± 0.03 ppt

(ii) *Recording thermograph*—In this instrument, a contact print of the position of a temperature-sensing, mercury column-in-glass-plate is made on 70 mm photographic film, which allows direct readings without magnification⁶. The pen position of an integrally mounted pressure indicator can also be recorded directly on the 70 mm film. This simple technique provides accuracy and reliability without complicated electronic circuitry. A solenoid-ratchet-stepping-mechanism advances the film 1 step per each sampling time-interval and spaces successive exposures at approximately 2 mm. At 1-step-per-hour-sampling-rate, the thermograph records for 400 days without replacement of batteries or film. Further, to ensure absolute reliability for the very long operating period, the instrument uses a phosphorescent light source with an embedded radioactive exciter to maintain constant light level without possibility of failure. The photographic film rests in virtual contact with the thermometer column and the pressure indicator, and is exposed by the light source between advances. Each thermometer degree mark and the 0 and 100% pressure range positions are recorded so that any lateral shift in film column will not affect accuracy.

TEMPERATURE MEASUREMENT IN THE SEA

Typical specifications:

Temperature range	: -2° to $+30^{\circ}\text{C}$; Accuracy: $\pm 0.2^{\circ}\text{C}$
Pressure range	: 0 to 15 psi, to 0 to 10000 psi; Accuracy: $\pm 1\%$ of full scale
Thermal response	: 10 minutes
Sampling rate	: 1 step/5 min to 1 step/12 hr
Film	: 100 ft spool Kodak photofluore

(iii) *Recording currentmeters*—Self-contained, recording currentmeters with temperature sensors can be used to obtain data on temperature (with an accuracy of about $\pm 0.1^{\circ}\text{C}$) at any depth. In these instruments normally a thermistor is used to measure temperature and the temperature data form one of the channels of the parameters recorded usually on a magnetic tape. A tape reader is used for translating data from the recorded magnetic tape to a computer compatible tape (CCT); or for on-line processing on a computer through RS 232 interface. A mooring of several recording currentmeters (with temperature sensors) provides record of temperature data at different depths in the sea continuously for long periods. Some types of recording currentmeters have the facility of acoustic telemetry for real-time data acquisition. One of the widely used recording currentmeters with temperature sensor⁷ is shown in Fig. 6.

(iv) *Moored data buoys*—Moored data buoys are used for continuous recording of oceanographic and meteorological parameters such as sea surface temperature, wave height, wind speed and direction, air temperature, atmospheric pressure in any geographic location of interest at sea. A typical data buoy consists of a hull or hollow cylindrical structure containing cylindrical wells, which holds power modules and processor modules. The sensors for meteorological parameters are mounted on a vertical mast on the buoy and the sensors for oceanographic parameters on the sides of the hull. Stabilisation of the buoy platform is achieved by employing a heavy keel held by guy wires. A zinc block is attached to the lower section of the buoy hull forming a sacrificial anode to provide protection

from corrosion. Usually platinum resistance thermometer is used as sensor to measure SST and the data is recorded in processor module on a data cassette. To facilitate recording of data for long periods (3 to 6 months), many high-capacity batteries are used in the power module. Besides internal recording, transmission of data in real-time can be achieved by using radio transmitter on the buoy platform and receivers on the shore stations. Real-time data acquisition is also possible through relay by satellites to earth receiving stations. National Institute of oceanography (NIO) has procured an oceanographic and meteorological data buoy from the Marine Exploration Ltd (MAREX, UK) and operated the same in the sea off Goa coast (Fig. 7). NIO has also developed a data buoy indigenously and tested at sea.

(v) *Drifting buoys*—Continuous recording of temperature at the sea surface and at different depths can be achieved by deploying drifting

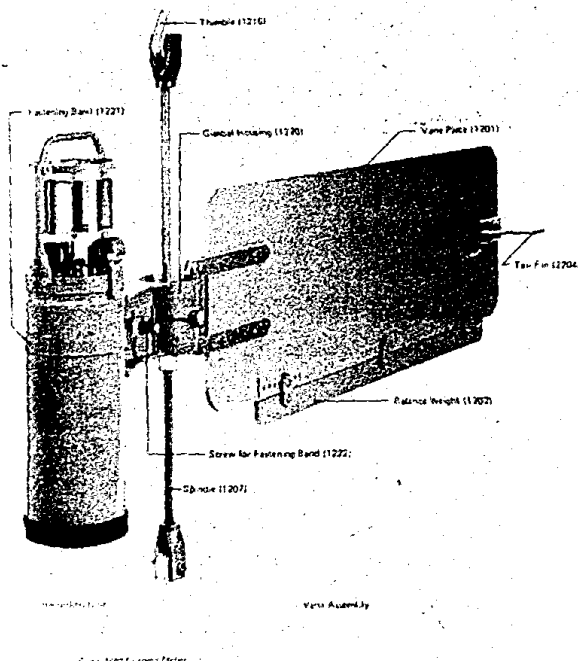

Fig. 6—Assembled Currentmeter with Recording Unit

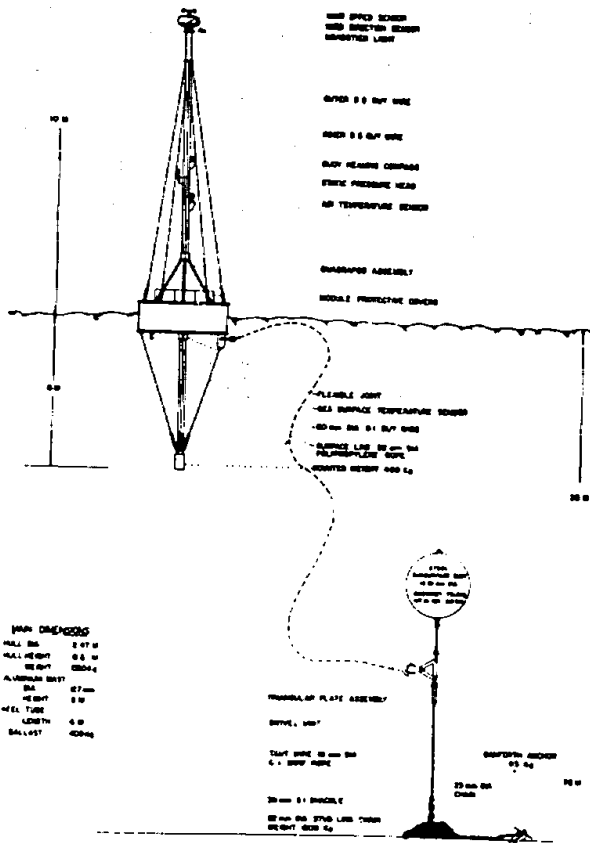

Fig. 7—Meteorological and Oceanographic Data Buoy

buoys, with thermistor sensors, in the open ocean. Usually meteorological drifting buoys sense SST whereas oceanographic drifting buoys measure subsurface also. A typical oceanographic drifting buoy used for subsurface temperature measurement has a thermistor string of ten thermistors suspended beneath and two pressure sensors spaced along the string to a depth of about 200 m. SST is measured by a hull mounted sensor. These drifting buoys are powered by batteries and the data acquired periodically and automatically are transmitted along with the platform position data for telemetering through orbiting satellites to earth receiving stations. The ARGOS system aboard TIROS/NOAA/NIMBUS satellites is used for data telemetry. NIO has procured from the Polar Research Laboratories, USA a few drifting buoys designed for providing information on Hull compartment temperature (SST), air tempera-

ture, atmospheric pressure and winds and use them in the Central Indian Ocean.

Equipment for specialised studies

(i) *Thermistor chain (towing type)*—Thermistor chain is a rather sophisticated temperature-measuring system for obtaining two dimensional sea temperature structure. This is also called “Contouring Temperature Recorder” and consists of the hoist, chain, generator and the drum on which the chain is wound. The chain is composed of flat links and consists of 30 to 40 thermistor sensors mounted at intervals of about 8 m⁸. The upper ends of the electrical leads from the sensors are connected to a recorder located in the ship’s laboratory, where signals from each of the sensors are scanned electronically, the scan cycle being about 12 sec. The order of sensing is from surface to the deepest sensor. The “chain” on the stern of the ship moves forward with the ship, the weight of the chain itself together with about 1000 kg weight at the end helping to keep it close to the vertical even at speeds up to 5 knots. In the recorder, the signals received from sensors are interpolated electronically and a continuous graph of whole number temperature values (isotherms) as a function of depth and time is drawn. The near-surface temperature measured by the upper most thermistor and the depth of the deep extremity of the chain measured by a pressure sensor are also recorded. This is a very useful system to study the upper ocean temperature structure and thereby to investigate the features like vertical motion, horizontal motion and turbulence (Fig. 8).

(ii) *Isotherm follower*—This is a specialised instrument designed for study of shallow water internal waves and is normally used from an oceanographic tower. The system seeks out an isotherm and follows it up and down in the water. This consists of a sea unit with temperature and pressure sensors, an electric winch controlling the cable to the sensing unit, a servo-mechanism, amplifiers, power supply and controls and

TEMPERATURE MEASUREMENT IN THE SEA

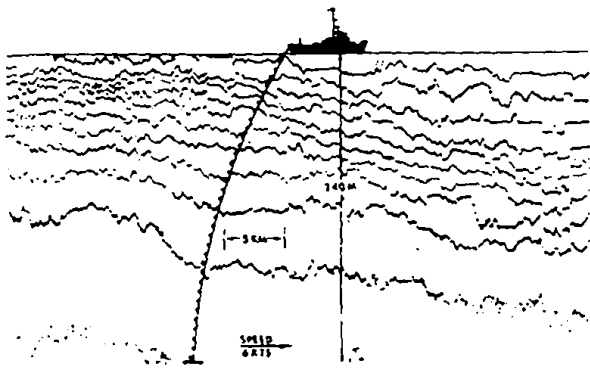

Fig. 8—Vertical temperature structure recorded by Towed Thermistor Chain

recorder for depth of the isotherm versus time. A thermistor in the sea unit is balanced in a bridge circuit with the resistance in one arm of the bridge corresponding to any desired temperature (isotherm). When the bridge becomes unbalanced, the winch is activated, causing it to either wind in or let out the cable. This continuous operation effectively locks the sea unit onto an isotherm. The output of the pressure sensor in the sea unit is continuously recorded. By triangular arrangement of isotherm followers, deployed from an oceanographic tower, it is possible to determine the period, height, speed and direction of internal waves⁹.

(iii) *Conductivity/salinity, temperature, depth systems*—CSTD systems are generally used for acquisition of high accuracy and high resolution temperature and conductivity/salinity data against depth, which are of immense value for studies on turbulence, diffusion and mixing in the sea. Usually these systems are either of self-recording and self-contained type, or powered from a deck unit through conducting armoured cable and data displayed/recorded on the deck units. Apart from conductivity/salinity, temperature and depth measurement, options with additional sensors to measure dissolved oxygen, pH, turbidity and sound velocity are also available in modern systems.

Self-contained STDs can be lowered by ordinary steel wire of a hydrographic winch used for

Nansen casts. In these instruments, which are somewhat less sensitive, temperature and salinity (calculated internally) are plotted on a graph versus depth. Usually a platinum resistance temperature sensor, an inductive type conductivity sensor and a strain gauge pressure/depth sensor are used in these systems. In recent versions, data are recorded internally on a magnetic cassette tape or stored in solid state memory chips which can be decoded and read on retrieval of the system to the deck.

A typical high resolution CTD system consists of an underwater probe unit with conductivity, temperature and pressure sensors, a deck control and indicating/recording unit and an armoured electrical conductor cable connecting them through a winch fitted with slip ring assembly. For temperature fine structure measurement, usually a transducer with a fine copper wire sensing element encased in an oil-filled stainless steel capillary tube (for good thermal contact) is used. This arrangement uses resistance change and consequent voltage change as output for measurement and has very low response time (less than 15 milliseconds). An electrode type conductivity cell of high stability and reduced proximity or 'area' effect, and a strain gauge pressure transducer are used as the other sensors. Outputs from the sensors (in the form of frequency analogs of each measurand) are multiplexed, filtered and amplified and transmitted as a composite signal through a single conductor cable to the deck unit, where the data are decoded and recorded in digital format. In some versions, a multi core armoured cable is used to transmit outputs from each sensor separately to the deck unit and the data in analog form is recorded on XY_1Y_2 chart. Probe unit and sensors of a CTD system made by M/s Guildline Instruments, Canada, are shown in Fig. 9 (a, b). Typical measuring ranges (in various steps) and accuracies:

Temperature range: -2° to $+35^{\circ}$ C; accuracy: $\pm 0.05^{\circ}$ C to 0.005° C.

Salinity range (from equivalent conductivity): 0 to 40 ppt; accuracy: ± 0.05 to ± 0.005 ppt.

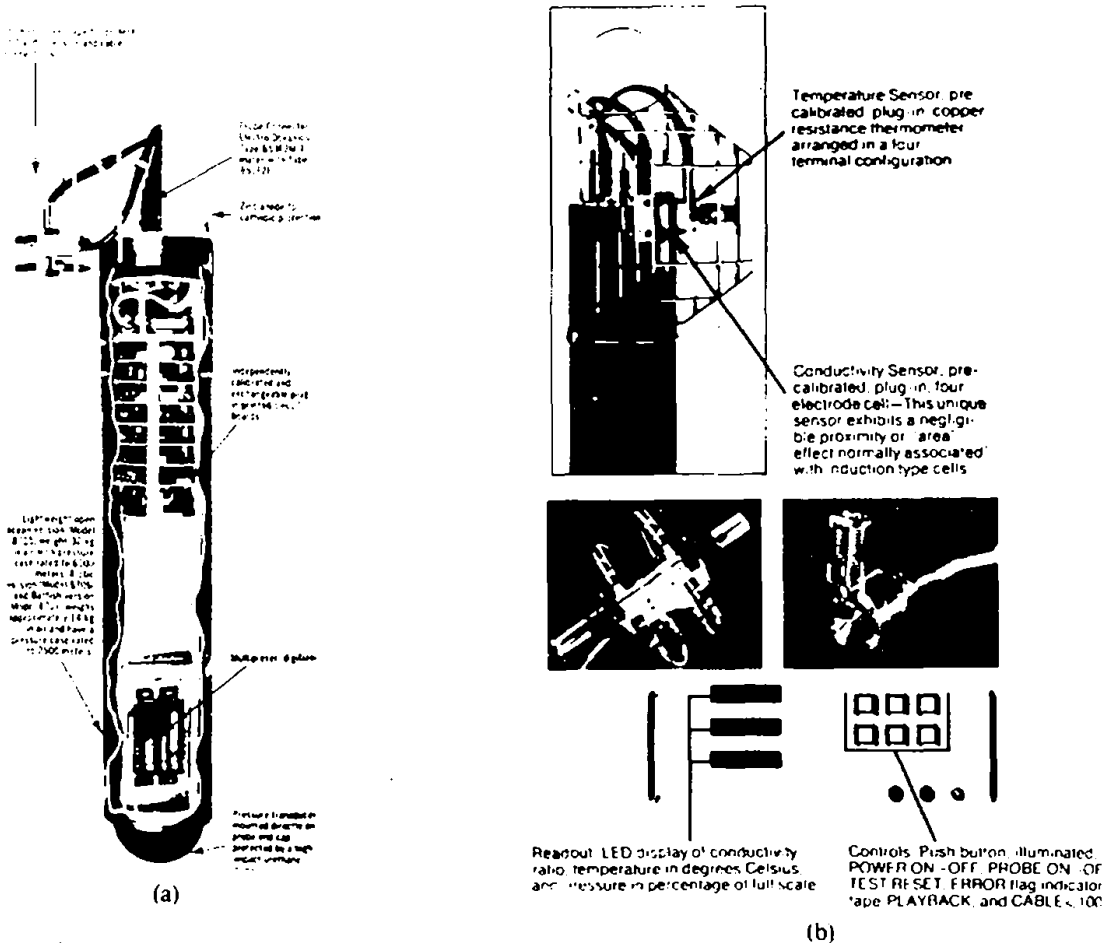

Fig. 9—Conductivity Temperature Depth System (a) Probe Unit (b) Sensors

Depth range (from equivalent pressure): 0 to 6000m; accuracy: $\pm 0.15\%$ to $\pm 0.25\%$ of full scale.

(iv) *Batfish*—Batfish is a depth controllable towed body which serves as a versatile platform for rapid collection of oceanographic data useful for studies on upper ocean temperature and salinity structures, frontal systems, etc. The batfish system consists of submersible body (batfish), to be towed behind a research vessel, connected with the deck control unit through a multicore (electrical) armoured cable on a bidirectional servo-controlled hydraulic winch¹⁰. Sensors designed to continuously measure temperature, conductivity, pressure are usually mounted on batfish. Option to use a fluorometer for dye studies, chlorophyll and turbidity measurement is also available in some versions. Output from the sensors is transmitted up the

tow cable to an onboard control unit, which displays the digital and/or analog values of the parameters measured. The batfish depth is controllable from the vessel by a control unit, which transmits and receives control signals via the tow cable. The control unit allows the operator to remotely set a fixed operating depth or the climb and dive rates and upper and lower limits of a desired profile. To reduce the risk of accident in shallow waters, a 'bottom avoidance' circuit (in the control unit) coupled to the vessel's depth sounder is used. Typical working depth of a standard batfish is up to 100 m (at low speed 4 to 10 knots). For work in deeper waters (up to 400 m), a 'wide-wing batfish' (Fig. 10) with faired cable is used. The temperature measuring range and accuracy achievable is determined by the temperature sensor of the CTD system used with

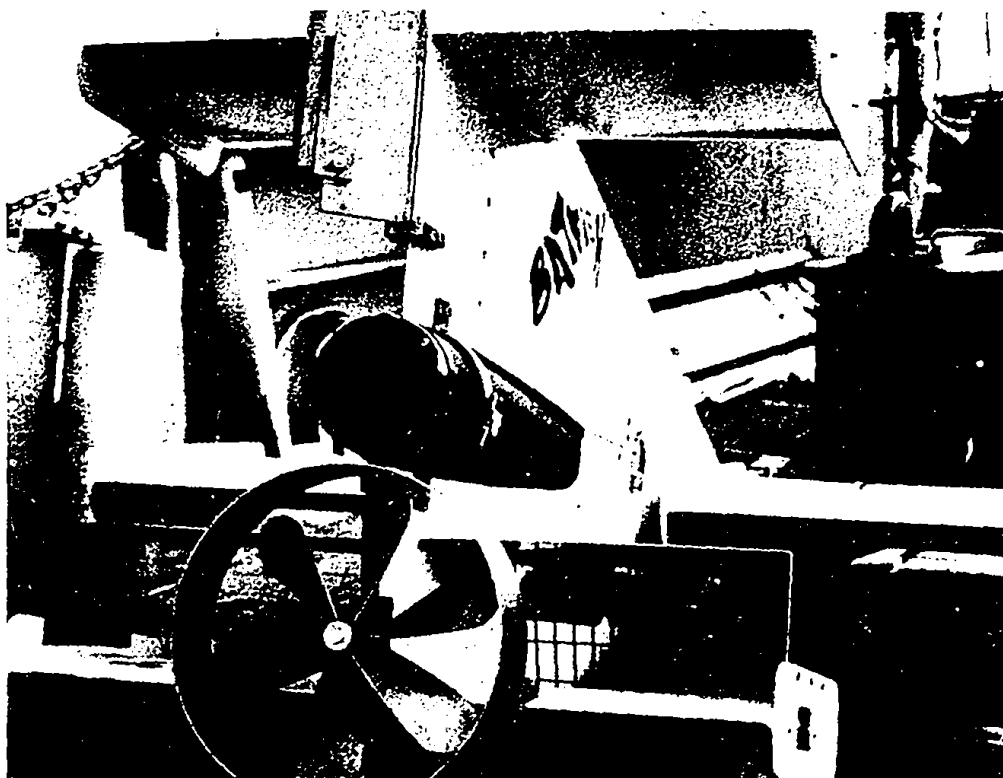

Fig. 10--'Batfish' with CTD Unit and Propeller

batfish. Generally a high resolution CTD system with temperature measuring accuracy of about $\pm 0.01^{\circ}\text{C}$ or more is used with 'Batfish'.

Thermistor chain (self-recording type) measurements in the Indian ocean from ORV Sagar Kanya

The new multidisciplinary Oceanographic Research Vessel (ORV) *Sagar Kanya*, acquired by the Government of India from West Germany in 1983, is equipped with several sophisticated instruments including a self-recording type thermistor chain (Temperature Profile Recorder TR-2) manufactured by M/s Ananderaa Instruments, Norway¹¹. By the use of the chain through a mooring or from a stationary ship, vertical time section of temperature distribution in the upper layers of the sea, which is very useful for studies on internal waves and other physical phenomena, can be obtained.

The instrument consists of a recording unit and a thermistor string (of 20m length) connected together by a water tight plug (Fig. 11). The thermistor string is a 15 conductor polyurethane cable with 11 thermistors built into it at regular space intervals (about 2 m). The thermistors used are 2K ISOCURVE Fenwal GB32 JM19 (with 5700 ohm at 0°C and 2001 ohm at 25°C). In the recording unit, a reference resistor and eleven thermistors (of the string) are multiplexed one by one into an electronic measuring bridge and voltages proportional to the respective temperatures are digitized by an A/D convertor and recorded on a $1/4''$ dual track magnetic tape in 10-bit binary format, as 'N' values which range from 0 to 1023. The recording unit also contains a quartz clock for starting the measurements at regular selectable sampling intervals and a 9-volt, 2 Ah battery for powering the unit. The recorder

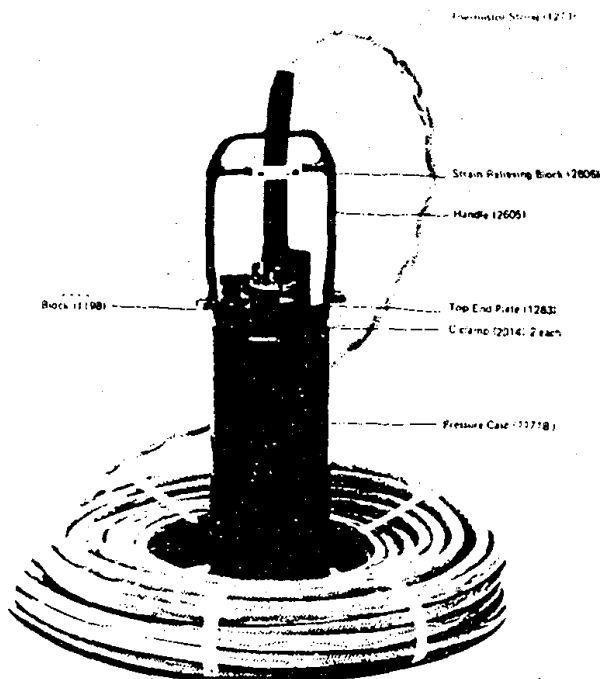

Fig. 11—Self-recording type Thermistor Chain

has an acoustic telemetering facility for real-time acquisition of the data through a hydrophone receiver.

Specifications:

Temperature ranges (selectable)

Low	: -2.46°C to 21.48°C
High	: 10.08°C to 36.04°C
Wide	: -0.34° to 32.17°C
Accuracy	: ±0.15°C
Resolution	: 0.1% of range selected
Thermal time constant	: about 1 minute
Sampling intervals (adjustable)	: 1, 2, 5, 10, 15, 20, 30, 60, or 180 minutes

During the first scientific cruise of ORV *Sagar Kanya* (July-Sept. 1983), in which the authors had an opportunity to participate, this instrument was operated from the ship on 6.8.1983 at Station No. SK-41 (position: equator, 52°E). With the sampling interval set to 1 minute, the chain was lowered from the ship to occupy 30 to 50 m depth from the sea surface and the data was recorded for about 3 hr on an experimental basis for testing the performance.

The data recorded by this instrument were processed in two stages, viz., translation of binary N values from original record on 1/4" magnetic tape to 1/2" CCT through Aanderaa Tape Reader and then computation of temperature from N values on 1/2" CCT, using a TDC/316 computer with RS 232 interface available at NIO. The following formula was used to compute temperature from N values:

$$T = (A + a) + (B + b)N + CN^2 + DN^3$$

where T is the temperature (computed) and A, a, B, b, C, D are the constants appropriate for the range of temperature measurement (which is wide range, viz., -0.34°C to 32.17°C chosen in the present case). The computer program in FORTRAN IV prepared and used for processing the data from 1/2" CCT is given below.

The processed data were plotted and analysed, and a vertical time section of temperature distribution in the layer extending from 30 m to 50 m depth prepared there-from is presented in Fig. 12. Even though the layer studied lies at thermocline top, where decrease of temperature was rather gradual and not so sharp, it is interesting to note that the section reflects the effect of internal waves.

Remote sensing of sea surface temperature

Remote sensing technique is a very useful tool in oceanography for synoptic and continuous spatial examination of oceanic properties over vast areas and thereby for obtaining information on the phenomena occurring simultaneously over large areas, which is not possible by the conventional ship-board measurements. Basically, remote sensing of the oceans consists of measuring reflected, scattered or emitted electromagnetic radiation at different frequencies emanating from the ocean surface. Since the nature of this electromagnetic radiation is closely related to the physical properties of the medium (ocean surface), some of the oceanic parameters/features in respect of sea surface and near surface phenomena can be inferred from it. This

TEMPERATURE MEASUREMENT IN THE SEA

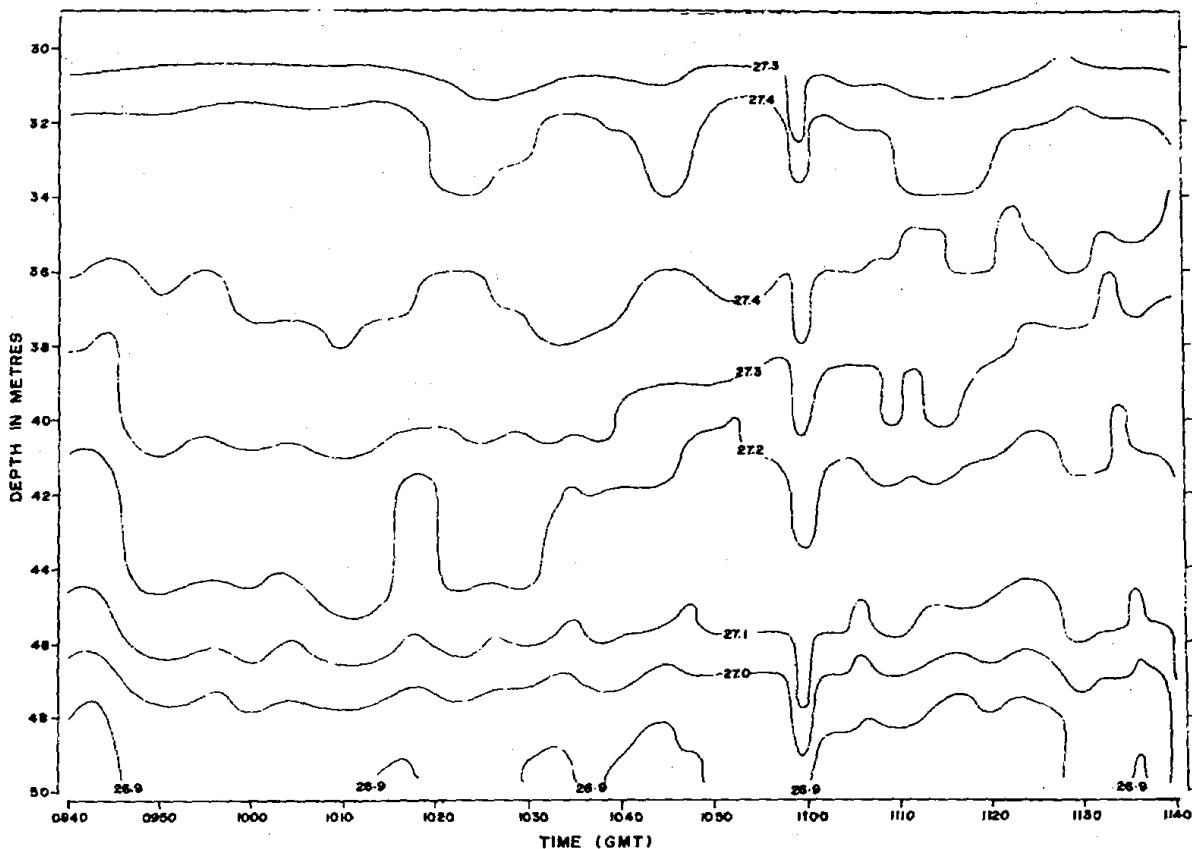

Fig. 12—Vertical time section of temperature at Station SK-41 (Equator, 52°E) obtained by a Self-recording Thermistor Chain.
(Local Time=GMT + 4 hours)

FORTRAN	T CHAIN		
		40	READ(9, 20, END = 70, ERR = 29) (N(I), I = 1, 72)
PROGRAM T CHAIN			M = 1
DIMENSION N(72), TEMP(72), TMP(72)			K = 12
A = -0.34907		210	M1 = M + 1
A2 = 0.03573		200	DO 100 I = M, K
A3 = -0.8388			TEMP(I) = A + [A2 * N(I)] + [A3 * A4 * N(I) * N(I)]
A4 = 1.0E-5			TMP(I) = TEMP(I) + (A5 * A6 * N(I) * N(I) * N(I))
A5 = 0.43		100	CONTINUE
A6 = 1.0E-8			WRITE (8, 30) [L, N(M), (TM(I), I = M1, K)]
L = 1			M = M + 12
IFL = 1			K = K + 12
FIND (9'IFL)			J = J + 1
300 WRITE (8, 50)			L = L + 1
50 FORMAT (1H1, 2X, 'SNO', 2X, 'REF', 4X, 'TMP1',			IF (J.EQ.31) GOTO 300
4X, 'TMP2', 4X, 'TMP3', 4X, 'TMP4', 4X, 'TMP5',			IF (M.GT.72) GOTO 40
4X, 'TMP6', 4X, 'TMP7', 4X, 'TMP8', 4X, 'TMP9',			GOTO 210
4X, 'TMP10', 4X, 'TMP11' //)		20	FORMAT [2 (35 (14, [X], 14)]
J = 1		30	FORMAT [2X, 2 (14, 2X), 11 (F6.3, 4X)]
GOTO 40		70	STOP
29 WRITE (8, 60)			END
60 FORMAT (4X, 'ERROR')			/ASSIGN M.09, DEVICE, NAME = MT, SNO = UNI, UBS = 179
			/Link

radiation can be detected by various types of sensors carried aboard aircrafts or satellites. Some sensors (the active type) have their own source of electromagnetic energy, whereas the others (the passive type) make use of the sun's radiation. The sensors include photographic and television cameras as well as optical scanners for observations in the visible (0.35 to 0.7 μm), radiometers for the infrared (particularly the 8 to 14 μm atmospheric "window") and for microwaves (about 1 to 5 cm) which can "see" through clouds (which blind the infrared sensors) and most recently, imaging and altimetric radars. The spatial resolution of the infrared radiometers/scanners is generally 1 to 7 km and that of the sensors operating in the visible range is 1 km or less, while that of microwave radiometers/scanners is 15 to 150 km and imaging radars is about 25 m.

Among the parameters amenable to remote sensing, is the sea surface temperature which is of vital importance in studies on air-sea interaction and monsoon dynamics, upwelling, currents, eddies and thermal fronts and also useful for weather forecasting. The thermal infrared data from satellites are specially useful for detecting the areas of upwelling and the associated regions of high biological productivity in the ocean and also to some extent for locating large oil slicks on the sea. SST maps prepared from air-borne infrared sensors are found to be of considerable assistance in the fishing for tuna.

(i) *Infrared radiometry*: Determination of SST by this method is based on the fact that ocean surface behaves like a black body in the infrared region from 4 to 13 μm , where its emissivity is nearly unity (0.98) and the emission obeys Stefan-Boltzmann Law.

$$W = E \sigma T^4$$

where W is total radiation flux emitted per unit surface, E is emissivity, σ is Stefan-Boltzmann constant (5.6×10^{-12} watts/cm²/deg.⁴) and T is the absolute temperature of the radiating surface.

The total radiation flux (W) at -2°C is 0.0304 watts/cm² and that at $+35^\circ\text{C}$ is 0.05 watts/cm² respectively.

The infrared radiation received by a sensor from the sea surface is affected by two factors, viz., selective absorption by atmosphere (which depends on altitude, air temperature and constituents like CO₂, ozone, water vapour) and radiation (from other objects, particularly sun) reflected from sea surface at certain wavelengths. In view of this, an infrared thermometer should be designed so as to respond to only those wavelengths at which the atmosphere is nearly transparent and the sea is black (non-reflecting). These conditions are largely fulfilled if the optical system of the radiometer contains filters to pass the radiation in the spectral region 8 to 13 μm only.

A typical Infrared Radiation Thermometer (IRT) consists of three main units: a thermistor-bolometer detector, an in-line reference cavity and signal-processing electronics. Solid-backed thermistor-bolometers are the mostly used. These devices are small, rugged, fast and sensitive having a noise equivalent power (nep) given by

$$nep = \frac{\sqrt{A}}{d_t} \times 10^{-8}$$

where nep is the power exposure required to obtain a signal-to-noise voltage ratio of unity, A is detector area (mm²) and d_t is the detector time constant (millisec). (Typical, $A = 1.0$ mm², $d_t = 2.8$ millisec and $nep = 3.6 \times 10^{-9}$ watts).

The thermistor element which has an active area of about 50 μm is optically immersed on the back of a germanium lens to facilitate use of a fast effective optical system for highest possible sensitivity. A resistance change of the order of one ohm in a one-meg ohm thermistor element takes place when the thermistor is exposed to radiant power. An electrical signal is produced by connecting two identical thermistor elements in a

TEMPERATURE MEASUREMENT IN THE SEA

ic bridge configuration and allowing radiation to strike one element while the second element is shielded from the radiation source and exposed only to the reference cavity, maintained at controlled temperature ($45^{\circ}\text{C} \pm 0.5^{\circ}\text{C}$). An optical chopper alternately exposes the unshielded element to target (ocean) radiation and to the internal reference cavity. The unshielded thermistor element cools when exposed to the ocean and heats when exposed to the reference cavity resulting in temperature changes of less than 0.001°C . Consequently the bridge unbalances by an amount proportional to the radiation from the ocean and the resultant electrical ac signal (via chopper action) is then amplified and read on a suitable voltmeter calibrated in degrees Centigrade. By using a Precision Radiation Thermometer (PRT)^{1,2}, the temperature measurement to an accuracy of $\pm 0.5^{\circ}\text{C}$ and sensitivity better than 0.1°C , can be achieved (Fig. 13). PRT can be used either from

aircraft for mapping SST over limited areas or from ships for sea truth measurement needed for validation of SST data derived from space borne radiometers.

The following space-borne infrared radiometers are very useful for determination of SST:

Sensor	Flown aboard	Spectral band (useful for SST determination)	Accuracy & resolution
AVHRR (Advanced Very High Resolution Radiometer)	NOAA-6,7 (Polar orbiting Satellites)	11.5-12.5 μm 10.5-11.5 μm 3.55-3.93 μm	Better than $\pm 1.0^{\circ}\text{C}$ spatial resolution 1.1 km
VHRR (Very High Resolution Radiometer)	INSAT-1(B) (Geostationary Satellite over Indian Ocean)	10.5-12.5 μm	About $\pm 1.0^{\circ}\text{C}$ spatial resolution 11 km

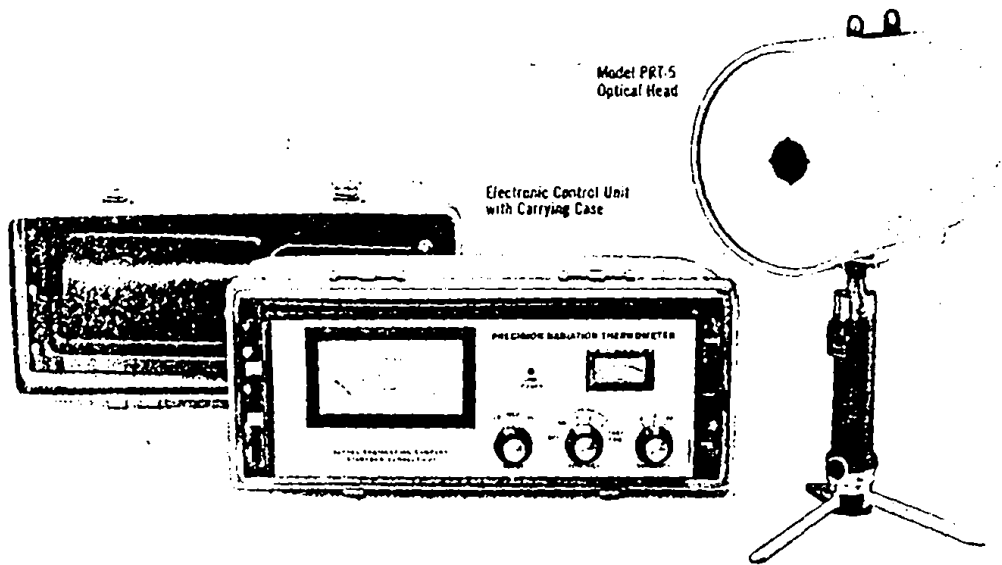

Fig. 13— Precision Infrared Radiation Thermometer

(ii) *Microwave radiometry*—This technique uses the fact that sea acts like a slab of dielectric and its complex dielectric constant is a function of Debye parameters in the static dielectric constant, the relaxation time and ionic conductivity. The Debye parameters derived from physical tables, as functions of temperature and salinity, gives indirectly the emissivity of a calm sea. When the sea becomes rough due to local wind field, white caps, foam and bubbles are formed and the effective microwave emissivity increases and the following relation holds:

$$T_B = e T$$

where T_B is the brightness temperature, T is the physical temperature (SST) and e is the effective microwave emissivity. Thus the brightness temperature of the sea surface is a function of SST, near-sea surface-wind speed and salinity. For determination of SST from space borne passive microwave radiometers, the effect of atmosphere has to be considered and T_B is given by the following relation:

$$T_B = T_1 + T_2 + T_3 + T_4$$

where T_1 is the surface radiance, T_2 is upwelling atmospheric radiance, T_3 is downwelling atmospheric radiance and T_4 is the radiance from space ($\sim 3^\circ\text{K}$). Data on brightness temperature at selected frequencies, measured by space-borne passive microwave radiometers, have been used successfully to obtain information on near-surface wind-speed, water vapour and liquid water in the atmosphere and SST. Brightness temperatures at 6.6 GHz (4.54 cm) and 10.7 GHz (2.8 cm) measured by Scanning Multichannel Microwave Radiometer (with spatial resolution of about 90 km) aboard experimental satellites SEASAT and NIMBUS-7 have been used to determine SST up to about $\pm 1.5^\circ\text{C}$ accuracy. In spite of less spatial resolution, passive microwave radiometry is advantageous for remote sensing OF SST from satellites in the presence of clouds.

Calibration of temperature measuring instruments in oceanography

Even though the manufacturers specify the accuracies and sensitivities of various sensors employed in the instruments, the sensors lose their original characteristics with time (age) and use, and need to be calibrated periodically for obtaining reliable data. Whenever major repairs are carried out or any principal components are replaced, recalibration of instruments is necessary. Because a wide variety of sensors/instruments are used for temperature measurement in the sea, the set-up/equipment required for their calibration is also of varied nature. A few typical calibration equipment used in oceanography are described briefly in this section.

(i) *Calibration of mechanical bathythermograph*—The Naval Physical and Oceanographic Laboratory (DRDO) has developed indigenously an equipment for calibration of mechanical bathythermograph in respect of temperature and pressure¹³. The equipment mainly consists of two parts, viz., the pressure system and the thermal system (Fig. 14). The pressure system comprises of a special pressure vessel (brass cylinder with flanges) connected to a hydraulic pump. The pressure vessel is provided with two lids, one at the top and the other at the bottom, both of which can be opened or closed by working a single hand wheel at the top. In the closed position, the pressure inside the wheel can be increased by the hydraulic pump, up to a maximum value corresponding to the water depth of 450 ft ($\sim 140\text{ m}$). The pressure vessel is placed inside a water bath. The thermal system comprises of the water bath provided with a refrigeration unit, two immersion heaters and stirrer (not shown in the figure). By means of this unit, the temperature of the bath can be varied and maintained at any value between 30°F (-1.1°C) and 110°F (43.3°C). The water bath is suitably insulated from the surroundings. For

TEMPERATURE MEASUREMENT IN THE SEA

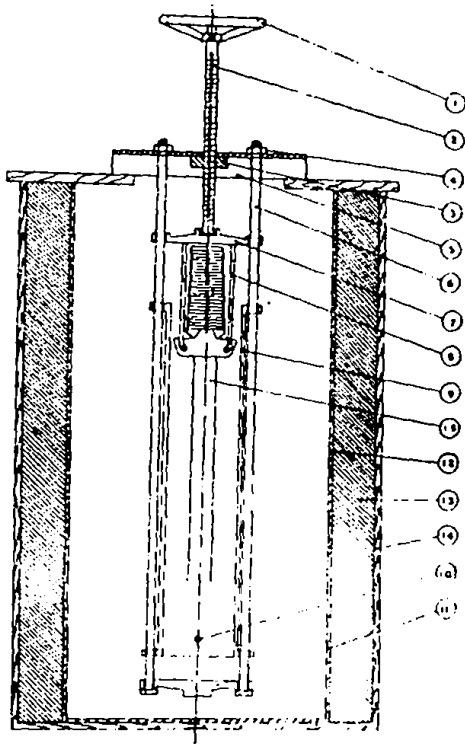

Fig. 14—Equipment for bathythermograph calibration

1 Handwheel, 2 steel screw, 3 nut welded to item no. 5, 4 brass nut for no. 6, 5, channel iron, 6 brass bolt, 7 upper lid, 8 suspension bracket for BT, 9 brass cylinder with flanges, 10 connection for hydraulic pump, 11 lower lid, 12 water container, 13 insulating material, 14 wooden box, 15 bathythermograph with loose piece removed

calibration, a smoked slide is put in the BT (to be calibrated), which in turn is fixed in the pressure vessel and the pressure vessel is immersed in the water bath. Both lids of the pressure vessel are kept open and temperature of the water in the bath and in the pressure vessel is maintained at a constant value, which is measured by an accurate thermometer. Then the hand wheel is operated to close both the lids of the pressure vessel and the hydraulic pump is operated to increase the pressure in the vessel to a desired value. During this process, a vertical trace extending up to the given depth is made on the smoked slide by the stylus of the BT. Then the pressure is released and both lids of the pressure vessel are opened, the

temperature is altered by about 1°F and the above procedure is repeated. These operations are repeated several times using a different combination of temperature and depth, and a series of parallel vertical lines extending to different depths are obtained on the slide. Then the BT is taken out of the calibration equipment and the slide is removed, washed, dried and lacquered. From this "calibration slide", a new grid is prepared using photographic techniques.

The accuracy of calibration that can be achieved by this equipment is 0.5 metres on the depth scale and 0.01°C on the temperature scale, while bathythermographs are usually calibrated to within 1 metre depth and 0.1°C temperature only.

(ii) *Calibration of reversing thermometers*—Equipment used for calibration of deep sea reversing thermometers at M/s GOHLA, West Germany¹⁴ are described here.

The equipment consists of two tanks, one for temperatures above 30°C and the second for temperatures between -3° and $+30^{\circ}\text{C}$. The tank for low ranges is in an airconditioned room capable of being cooled down to approximately 8° to 10°C . Under the tank there is a heater switchable in 6 steps from 45 to 950 watts, indirect cooling part and pump with motor. The intake water flows from the tank through the heating and cooling coils and is pumped back into the tank through a perforated pipe at high pressure, mixing the water in the tank continuously and constantly without a whirlpool. The heating is regulated by an electronic temperature control system. The required temperature is adjusted manually and controlled by standard thermometers graduated in $1/100^{\circ}$ and $1/50^{\circ}\text{C}$. Four sensitive thermistors direct the temperature control system for balance; in the lowest heating step, only a fraction of the

minimum 45 watts is required. In a separate tank the coolant can be maintained at any temperature between -10° and $+25^{\circ}\text{C}$ accurate to approximately $\pm 0.1^{\circ}\text{C}$. Another pump circulates the liquid at a regulated rate through the heat exchanger, in the main pump, continuously. In balance the test bath could be set to maintain a constant temperature within $\pm 0.003^{\circ}\text{C}$ for a longer period of time. Insulation thickness of the double walled cover of the tank is 40 mm and is filled with self-expanding polystyrene foam. The tank capacity is 100 litres. Viewing is accomplished through a double thermopane window in front.

Recently, the National Physical Laboratory (CSIR) has also developed calibration equipment for reversing thermometers.

(iii) *Calibration of high resolution systems*—Modern equipment used for temperature measurement in the sea employs high resolution sensors with good accuracy. For calibration of such equipment, high quality temperature standards are essential. A platinum thermometer with a resistance bridge or a quartz thermometer can be used as temperature standards.

Platinum resistance temperature detectors (RTDs) are recognised as the most reliable standard for measuring and comparing temperature information, because platinum provides long term stability and repeatability. They have a wide temperature range. It is possible to obtain resolution of several tenths of a millidegree with platinum resistance thermometers when used with a high quality Mueller Bridge and a very sensitive galvanometer.

Quartz thermometers, using linear-quartz crystals as temperature sensing elements, offer very high sensitivity and serve as good temperature standards. Usable sensitivity is 0.0003°C for absolute measurements and 0.0001°C for differential measurements. In quartz

thermometer, the frequency of an oscillator under the control of the crystal is measured. At 0°C temperature, the natural frequency of a quartz plate vibrating in the third overtone, thickness-shear mode, is nominally 28.208 MHz. The temperature coefficient of the crystal with this frequency is 1000 Hz/degree centigrade. In this mode, a high speed counter can be used directly to measure the frequency of the oscillator which, after subtraction of the zero-degree frequency, yields the absolute temperature of the crystal. In practice, an automatic zero-degree frequency subtraction during measurement is done to facilitate use of a slower counter. This technique makes possible direct digital display which is advantageous.

(iv) *Variable temperature salinity baths*—These are special type of baths designed to accommodate the sensors of high resolution temperature and salinity measuring instruments and to provide controlled conditions of temperature and salinity while performing calibration tests and adjustments. A typical bath consists of a cabinet with a tank for containing the working fluid, which may be distilled water or tap water or natural/artificial sea water. A motor-driven agitator in the bottom of the tank mixes the working fluid to minimize gradients. Valves for filling and draining the tank are provided. The fluid can be circulated in an external equipment, by means of insulated pipes, as an option.

The temperature in the bath can be maintained at any desired value by employing heaters and condensing units and a suitable temperature sensor and controller. Panel controls, which can be set for manual or automatic temperature control are provided usually. (A dead band electronic temperature control permits adjustment of the sensitivity of the heating/cooling delay¹⁵). Sensitivity to heating or cooling will be around 0.06°C to $\pm 1.6^{\circ}\text{C}$ with a re-setting accuracy of $\pm 0.25\%$. Also, over-temperature cut out can be achieved by using remote bulb temperature control in series with the heating

TEMPERATURE MEASUREMENT IN THE SEA

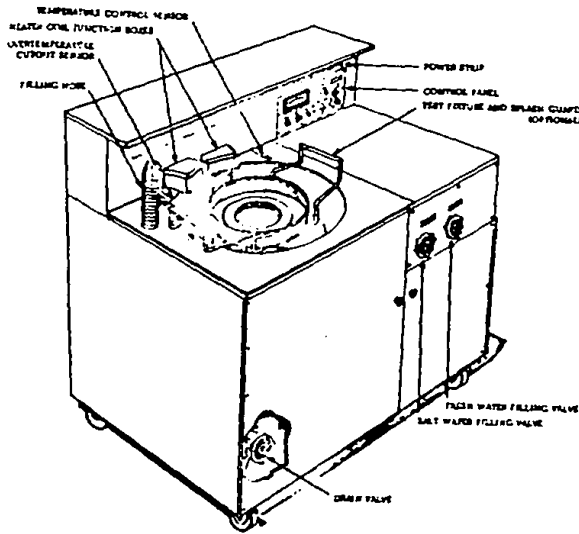

Fig. 15— Variable temperature—salinity bath

solenoid. This is set for 50°C in Model 7600 Variable Temperature Salinity Bath made by M/s Grundy Environmental Systems, USA, shown in Fig. 15.

Variable temperature baths with the range -20°C to +70°C are available. The working fluid for temperature down to 10°C may be water but for lower temperatures glycol or alcohol and water mixtures must be used to prevent damage to the bath. For cooling below room temperature a continuous duty compressor with large capacity copper heat exchanger precharged with refrigerant such as R-12 or R-22 Freon gas may be used. The temperature control may also use a solid state control panel controlling power, pump, heat and refrigeration and operating with a magnetic setting of a thermoregulator to hold temperatures to within $\pm 0.02^\circ\text{C}$. The thermoregulator is usually of mercury-in-glass type which upon reaching set temperature shorts and cuts off a silicon-controlled rectifier in the power circuit.

These variable temperature salinity baths can be used to calibrate C/STD systems, temperature-

salinity bridges, precision infrared radiation thermometers, etc.

Acknowledgement

The authors wish to thank Dr VVR Varadachari and Dr JS Sastry for their encouragement and interest in this work. They are also thankful to Mr MSS Sarma and Mr K Santanam for their help and to Mrs Sheila Vaz and Mr Ramesh S Bhinghe for typing the manuscript.

References

- 1 Wyrski K, *International Indian Ocean Expedition Oceanographic Atlas* (National Science Foundation, Washington D.C.), 1971.
- 2 Morris Schulkin, *Basic Acoustic Oceanography* (US Naval Oceanographic Office RP-1, Washington D.C.) (1975) 13.
- 3 Sverdrup H U, Johnson M W & Fleming R H, *The Oceans—Their Physics, Chemistry & General Biology* (Asia Publishing House) (1961) 351.
- 4 *Instruction Manual for Expendable Bathothermograph System* (Electronics Corporation of India Ltd, Hyderabad) (1979).
- 5 *Instruction Manual for Model 6600T Thermosalinograph* (Plessey Environmental Systems, USA).
- 6 *Brochure on Vehicles & Instrumentation for Marine Research & Ocean Operations* (Braincon Corporation, USA) (1967).
- 7 *Operating Manual for Recording Currentmeter Model 4* (M/s Aanderaa Instruments, Bergen, Norway) (1978).
- 8 Lafond E C & Lafond K G, *Vertical and Horizontal Thermal Structures in the Sea*, NEL/Report 1395 (US Navy Electronics Laboratory, California, USA) (1966).
- 9 Lafond E C & Lee O S, *Internal Waves in the Ocean Navigation*, 9(3) (1962) 231.
- 10 *Batfish Summary Manual* (M/s Guildline Instruments, Canada) (1980).
- 11 *Operating Manual on Temperature Profile Recorder TR-1/2* (M/s Aanderaa Instruments, Bergen, Norway) (1980).
- 12 *Instruction Manual on Precision Radiation Thermometer Model PRT-5* (M/s Barnes Engineering Co, USA).
- 13 Balakrishnan A & Shanmukham A K, *Bull Nat Inst Sci India*, 38 (1968) 334.
- 14 *Brochure on Deep-Sea Reversing Thermometers* (M/s GOHLA, West Germany) (1981).
- 15 *Instruction Manual on Model 7600 Variable Temperature Salinity Bath* (M/s Grundy Environmental Systems, Inc., USA) (1979).

**Appendix 1—Approximate Costs of Some
Instruments**

Sl No.	Name of the instrument	Approximate cost (Rs)	Remarks
1 (a)	Precision Deep Sea Reversing Thermometer, protected type (with test certificate)	2,500	
(b)	Precision Deep Sea Reversing Thermometer, unprotected type (with test certificate)	3,500	
2	Temperature Salinity Bridge (with 100 ft cable)	30,000	Developed by NIO in India
3	Mechanical Bathythermograph	18,000	
4 (a)	Expendable Bathythermograph (Recorder with hand-held launcher)	1,00,000	Made by ECIL in India
(b)	XBT Probe (0-460 m)	700	Made by ECIL in India
5	Thermosalinograph system	3,00,000	
6	Recording Currentmeter (with temperature sensor)	45,000	
7	Meteorological and Oceanographic Data Buoy	10,00,000	Developed by NIO also in India
8	Drifting Buoy	1,60,000	
9	Thermistor Chain (self-recording type)	45,000	
10	C/STD System (0.6000 m)	6,00,000	CTD for use up to 700 m depth was developed by NIO in India
11	Precision Infrared Radiation Thermometer System	2,20,000	
12	Variable Temperature Salinity Bath System	3,50,000	

ABOUT THE AUTHOR



Shri R J Krishnama Charyulu was born in the village of Vinnakota (Krishna District, Andhra Pradesh) on 5 March 1951. Obtained B.Sc. degree with Physics (Major) and Maths (Minor) in 1970 and B.E. degree in telecommunication engineering in 1974 from Vijayanagar College, Hospet and College of Engineering, Gulbarga, both then affiliated to Karnatak University, Dharwar. In 1976, M.Tech. degree in Physical Engineering was obtained from the Physics Department of Indian Institute of Science, Bangalore. He has specialised in Electronics, Instrumentation and Materials Sciences.

After a brief scientific career in the Department of Electrical Communication Engineering of IISc in December 1977, joined Associated Cement Company (A.C.C.) as Junior Engineer and worked in Kymore and Porbandar Cement Plants. From 1980 onwards served in the National Institute of Oceanography (CSIR) in various capacities and presently working as scientist 'B' in its Physical Oceanography Division. Has experience in instrumentation on board oceanographic research vessels "GAVESHANI" and "SAGAR KANYA".

ABOUT THE AUTHOR



Shri L V Gangadhara Rao was born in Eluru (Andhra Pradesh) on 24 April 1941. Obtained B.Sc. degree in Physics in 1960 and M.Sc.(Tech.) degree in Meteorology and Oceanography in 1963 from the Andhra University, Waltair. He had joined as a Research Fellow of INCOR (Indian National Committee on Oceanic Research) in November, 1963 and worked for the Indian programme of IIOE (International Indian Ocean Expedition) until 1965 and then continued as a Research Fellow of NIO (National Institute of Oceanography) at its Data Centre, then located at New Delhi. Joined in as a Scientist, NIO at its permanent establishment at Goa in October 1968 and continued his work in the Physical Oceanography Division, where he presently serves as an Assistant Director handling research projects on oceanic physical processes and ocean remote sensing.

Shri Rao has a vast field and research experience in Physical Oceanography. Participated in various oceanographic expeditions in the Indian Ocean including MONEX-79 and led many oceanographic cruises as Chief Scientist, including the first scientific cruise of ORV SAGAR KANYA during the summer monsoon of 1983. Has more than 25 research publications to his credit.