

EXPERIMENTAL AND THEORETICAL STUDY OF WAVE  
FORCES ON PERFORATED BREAKWATERS  
WITH SPIKES

P. S. RENUKARADHYA\*

Faculty of Marine Science and Technology  
Tokai University  
1000, Orido, Shimizu City, Japan-424

ABSTRACT

The usefulness of spikes superimposed on perforations on breakwater walls in reducing the wave force is investigated for the first time in this study. Breakwater walls inclined at  $57^\circ$  and  $65^\circ$  were provided with 16% and 21% perforations. Spikes were superimposed on these perforations. Horizontal and uplift forces on inclined walls with and without perforations/spikes and also those on solid vertical walls were measured for different parameters. These experimental values were compared with the theoretical values computed by using Sainflou's method. Combination of 21% perforations and spikes on  $57^\circ$  wall proved to be the most effective in wave force reduction. The wave forces in this case were found to be only 40% of those on solid vertical walls at short wave periods.

The wave heights within the body of the model were compared with the incident waves. In case of  $57^\circ$  wall provided with 16% perforations and spikes, the wave heights within the model were found to be only 50% of the incident wave heights in case of short waves.

INTRODUCTION

In 1961, Jarlan applied acoustic theory to the reflective properties of coastal engineering structures and proposed to provide perforations on the outer periphery of the structure to reduce the reflected wave energy thereby making the structure safer and more economical. Since then a number of harbour structures such as breakwaters and offshore structures have been constructed in several continental shelves. Ekofish oil storage tank constructed in North Sea in 1972 is one typical example of such perforated structures.

Though perforated structures are being constructed in many countries ever since the concept of perforations was introduced, there is still a lot of controversy about the percentage of perforated area, the chamber length relative to wave length, the diameter of perforations relative to wall thickness, etc. to obtain maximum reduction in wave forces. This study attempts to solve some of these problems.

---

\*Present Address: Ocean Engineering Division, National Institute of Oceanography, Dona Paula, Goa-403 004.

Model studies were conducted on breakwater models with vertical and inclined faces. Two inclined faces provided with two different perforations were tested. To investigate if the wave forces could be reduced further by superimposing spikes between perforations, spikes were fixed for the first time in this study. Experimental values of both horizontal and uplift forces were compared with the theoretical values computed by using Sainflou's method. Wave height reduction in model chambers is also studied by recording both incident waves and the waves within the model. Results of the above investigations are presented in this paper.

## EXPERIMENTAL WORK

### MODELS

Models with vertical face and also with faces inclined at the angles of  $57^\circ$  and  $65^\circ$  were manufactured to a model scale of 1 : 25. Perforations with void ratios of 16% and 21% were made on the inclined faces. Spikes were fixed both on perforated and unperforated inclined faces. To prevent overtopping of waves, a 10 cm high wall with a curved face was fixed at the top of the models over the entire width. In order to facilitate the insertion of wave recorders inside the body of the model, a hole 10 cm in diameter was provided at the top. The side walls were made of plastic for making them transparent to make the observation of wave pattern within the model possible. All other sides were made of timber planks. Additional weights were added at suitable heights on the inner faces of front and back walls as per the similitude law. Fig. 1 shows the three models tested. Front faces with 16% and 21% perforations were fixed at the angles of  $57^\circ$  and  $65^\circ$  in each side. Spikes were superimposed on these perforations by fixing them with screws. Fig. 2 shows the various combinations of perforations and spikes tested. Fig. 3 shows the size of each spike. The wall fixed on top of each model to prevent overtopping is shown in Fig. 4. The different cases tested are listed below:

- (i) Vertical face with no perforations and no spikes.
- (ii) Front face inclined at  $57^\circ$  and with no perforations and no spikes.
- (iii) Front face inclined at  $65^\circ$  and with no perforations and no spikes.
- (iv) Front face inclined at  $57^\circ$  and with perforations only.
- (v) Front face inclined at  $57^\circ$  and with spikes only.
- (vi) Front face inclined at  $57^\circ$  and with both perforations and spikes.
- (vii) Front face inclined at  $65^\circ$  and with perforations only.

- (viii) Front face inclined at  $65^\circ$  and with spikes only.
- (ix) Front face inclined at  $65^\circ$  and with both perforations and spikes.

#### EXPERIMENTAL SET UP

Experiments were conducted in a wave flume 30 m long, 1.0 m wide and 0.6 m high fitted with a flap type wave generator. The model was placed at a distance of 19.85 m from the flap. It was hung from the top of the flume with an L-arm supported by a frame by leaving a gap of 1 cm from the bottom of the flume. Fig. 5 shows the L-arm used for supporting the model. Two wave recorders - one inside the body of the model and another at a distance of 12.20 m from the centre of the model - were used to record the wave heights inside the body and the incident wave heights. The experimental set up is shown in Fig. 6.

The horizontal and uplift forces arm were measured by fixing 16 strain gauges to the supporting L-arm as shown in Fig. 5. Four gauges fixed on each of the horizontal and vertical models were connected to one Wheatstone bridge as shown in Fig. 7.

The strain gauges were calibrated by applying horizontal and vertical forces manually by using a pulley system and weights. The wave recorders were calibrated by immersing them in static water manually. The forces and wave heights were recorded on oscillographs by using amplifier and recording instrument.

#### WAVE PARAMETERS

Model waves of 5 cm, 7 cm, 10 cm and 14 cm heights and 1.1 sec and 2.6 sec periods were generated. These parameters and their corresponding values in prototype are tabulated in Table 1. A water depth of 40 cm corresponding to 10 m in prototype was maintained in the flume through out the experimental work.

#### THEORETICAL COMPUTATION OF WAVE FORCES- SAINFLOU'S METHOD

Since the waves considered in this investigation are non-breaking waves, the wave forces on breakwater structures are primarily hydrostatic. Sainflou (1928) proposed a method for determining the pressure due to non-breaking waves. Both horizontal and uplift forces are computed by using this method. Though, Sainflou's method is used for the computation of wave forces on vertical walls, it is applied for both vertical and inclined walls in this investigation. This method is explained below briefly.

The wave crest is assumed to be  $H + \delta_0$  above SWL and the wave trough  $H - \delta_0$  below SWL. The shift of mean water level is calculated by

$$\delta_0 = \frac{\bar{\Lambda} H^2}{L} \operatorname{Cot} h \frac{2\bar{\Lambda} h}{L} \dots\dots\dots (1)$$

The force intensities  $P_1$ ,  $P_2$ ,  $P_2'$  at different levels shown in Fig. 8 are given by the following equations:

$$P_1 = (P_2 + W_0 h) \left( \frac{H + \delta_0}{h + H + \delta_0} \right) \dots\dots\dots (2)$$

$$P_1' = W_0 (H + \delta_0) \dots\dots\dots (3)$$

$$P_2 = P_2' = \frac{W_0 H}{\operatorname{Cos} h \frac{2\bar{\Lambda} h}{L}} \dots\dots\dots (4)$$

The uplift force distribution is triangular as shown in Fig. 9. The pressure intensity at the bottom of the front face of the structure  $P_u$  is given by

$$P_u = P_2 = \frac{W_0 H}{\operatorname{Cos} h \frac{2\bar{\Lambda} h}{L}} \dots\dots\dots (5)$$

The computed horizontal and uplift forces for different parameters are tabulated in Table 2 and Table 3.

## RESULTS AND DISCUSSION

### HORIZONTAL FORCES

Fig. 10 to Fig. 13 show the comparison of theoretical values of horizontal wave force with those measured experimentally for different wave heights and wave periods.

Fig. 10 compares the forces on  $57^\circ$  wall due to 1.1 sec wave period with wave heights ranging from 5 cm to 14 cm. As could be seen from the measured forces, the decrease of wave force in case of perforated walls and also perforated walls fixed with spikes, is significant. The forces on perforated walls with and without spikes are only half of those on vertical wall on an average, for all wave heights. The reduction of forces provided with both

perforations and spikes is more than the reduction in the case of perforations alone. This shows clearly that spikes superimposed on perforations are effective in further reducing the wave forces on structures. When spikes are not fixed, 21% perforations have shown better results compared to 16%. The combination of 21% perforations and spikes has proved to be most effective at this wave period.

The wave forces on the walls fixed with spikes alone are more than those on the solid walls without spikes as could be expected. The additional frictional resistance due to spikes increases the wave forces by about 10%. The forces on plain inclined walls are less than those on plain vertical wall.

In case of lower wave heights the measured wave forces on perforated walls superimposed with spikes are only one third of the computed values for solid vertical wall. Even for higher waves, the computed values are more than double the experimental values on these walls. On the other hand, computed values in case of solid walls, though slightly higher than the experimental values, represent the actual values with a fair degree of accuracy.

Fig. 11 compares the experimental and theoretical values on 57° wall for 2.6 sec wave period. The decrease of wave force due to perforations and spikes is not so significant as in the previous case. In case of higher waves, the experimental values show a reduction of about 30% while at lower heights the reduction is negligible. At this wave period of 2.6 sec, 16% perforations have proved to be better than 21%. The same tendency is observed when superimposed with spikes.

The tendency of the increase of forces due to spikes fixed on unperforated walls is clear in this case also. Computed forces are almost double the measured values in case of long periods, and are thus not representative of actual forces.

The forces on 65° wall due to waves with 1.1 sec period are compared in Fig. 12. The reduction due to perforations and spikes is as much as 55% for lower wave heights and 30% for higher waves. 21% perforations have proved to be better than 16% both with and without spikes. Combination of 21% perforations and spikes has proved to be the best in this case also.

Fig. 13 shows the comparison for 65° wall and 2.6 sec wave period. Perforations and spikes are not helpful in reducing the wave forces substantially at this long period. Computed values are observed to be more than the measured ones in both the cases.

#### UPLIFT FORCES

Theoretical and measured uplift forces on 57° and 65° models are compared for 1.1 sec and 2.6 sec wave periods in Fig. 14 to Fig. 17.

Fig. 14 shows the comparison for 57° wall and 1.1 sec wave period. As could be seen from the comparison of experimental values for vertical and inclined walls, perforations and spikes reduce the uplift forces significantly. The forces are halved at lower wave heights and become as less as one-third at higher wave heights. 16% perforations are more effective in case of uplift forces than 21%. Maximum reduction is achieved by combining spikes with 16% perforations.

As the wave period increases the uplift forces increase substantially as shown in Fig. 15. In case of solid wall, the magnitude of uplift forces is almost the same as horizontal forces. Inclined walls without perforations and spikes experience less forces than vertical wall. The forces on vertical wall is about two times those on inclined wall for lower wave heights and about one and a half times for higher waves.

The perforations and spikes significantly reduce the uplift forces. The forces on perforated walls with and without spikes are only 25% of those on solid wall. Spikes superimposed on 16% perforations have again proved to yield maximum reduction in uplift forces.

Fig. 16 shows the comparison for 65° wall and 1.1 sec wave period. The variation of forces along with wave height is almost the same as in the case of 57° wall and 1.1 sec wave period. 16% perforations are more effective than 21%. 16% perforations both with and without spikes have shown to yield maximum force reduction in this case.

The computed and measured forces are compared in Fig. 17 for 65° wall and 2.6 sec wave period. In case of lower wave heights the forces on solid wall are as much as three times the forces on perforated walls with and without spikes. The gap widens as the wave height increases. At the wave height of 14 cm, the forces on vertical walls are five times the forces on perforated walls with and without spikes. Both 16% and 21% perforations with and without spikes have shown almost the same force reduction in case of long wave period at this inclination.

The computed forces agree well with the experimental values in case of uplift forces. In general, both the values at shorter wave period of 1.1 sec are almost half the values at 2.6 sec period.

#### WAVE HEIGHTS INSIDE THE MODELS

The ratios of wave heights within the body of the models and the incident wave heights are tabulated in Table 4 for different cases. The wave heights within the model are comparatively lesser for shorter period than longer period. Spikes superimposed on perforations have tendency to further reduce the wave heights within the models. The front wall inclined at 57° with both perforations and spikes has resulted in minimum wave heights for

the four incident wave heights to which the models were exposed.

#### CONCLUSIONS

1. At short wave periods, combination of 21% perforations and spikes on 57° wall has proved to be most effective in dissipating wave energy. The horizontal wave forces in this case are only 40% of those on solid wall. However, at long periods, perforations and spikes do not reduce horizontal forces significantly particularly at lower wave heights. A reduction of 30% is observed at higher wave heights. 16% perforations have proved to be more useful than 21% at long periods.
2. Spikes combined with perforations are useful in considerably reducing the uplift forces. Maximum reduction is achieved by the combination of spikes and 16% perforations on 57° wall. The uplift forces in this case are only 25% of those on vertical models.
3. Horizontal forces on vertical models computed by using Sainflou's method are slightly higher than the experimental values at short periods but represent the actual values with a fair degree of accuracy. But at long wave periods, computed wave forces are almost double the measured values and are thus not representative of the actual values.
4. The uplift forces increase significantly with the increasing wave period and become almost the same as horizontal forces at long wave periods. The computed uplift forces agree well with the experimental values both at short and long periods.
5. The frictional resistance due to spikes fixed on unperforated inclined walls increases the wave forces acting on the structure by about 10%.
6. Combination of spikes and 16% perforations on 57° wall has resulted in minimum wave heights within the model.

#### ACKNOWLEDGEMENTS

This research work was carried out at the Faculty of Marine Science and Technology, Tokai University, Japan. The author thanks the staff and students of the Ocean Engineering Department of the Faculty for their help and co-operation during the experimental work. Grateful thanks are due to Dr. M. Nishimura, Dean of the Faculty for his kind encouragement and help during the author's stay at the Faculty. Thanks are also due to Dr. B. U. Nayak, Head, Ocean Engineering Division and Dr. V. V. R. Varadachari, Director, National Institute of Oceanography, Goa for the facilities while preparing this paper.

## REFERENCES

1. Jarlan, G. L. E. (1961). "A Perforated Vertical Wall Breakwater", the Dock and Harbour Authority, Vol. XLI, No. 486, pages 394-398.
2. Jarlan, G. L. E. (1965). "The Application of Acoustic Theory to the Reflective Properties of Coastal Engineering Structures", National Research Council of Canada, Report No. DME/NAE, pages 23-63.
3. Lean, G. H. (1967), "A Simplified Theory of Permeable Wave Absorbers," Journal of Hydraulic Research, Vol. 5, No. 1, pages 15-30.
4. Marks, W. (1966), "A Perforated Mobile Breakwater for Fixed and Floating Applications," Proceedings of the Tenth Conference on Coastal Engineering, American Society of Civil Engineers, Vol. 2, pages 1079-1129.
5. Marks, W., and Jarlan, G. L. E. (1968), "Experimental Studies on a Fixed Perforated Breakwater", Proceedings of the Eleventh Conference on Coastal Engineering, American Society of Civil Engineers, Vol. II, pages 1121-1140.
6. Sainflou, G. (1928), "Essai Sur Les Dignes Maritimes Verticales, Ann. Ponts et Chauss, 98, No. 4.

## DEFINITION OF SYMBOLS USED

H	-	Wave amplitude
L	-	Wave length
h	-	Water depth below MWL
	-	Water density
	-	Shift of MWL
$P_1$	-	Water pressure at MWL when the crest approaches the vertical wall
$P'_1$	-	Water pressure at MWL when the trough approaches the vertical wall.
$P_2$	-	Water pressure at the bottom of vertical wall when crest approaches
$P'_2$	-	Water pressure at the bottom of vertical wall when the trough approaches
$P_u$	-	Uplift pressure at the front side of vertical wall
$F_{Hcr}$	-	Horizontal wave force at wave crest
$F_{Htr}$	-	Horizontal wave force at wave trough
$F_{Har}$	-	Horizontal wave force (average)
$F_u$	-	Uplift force
$H_c$	-	Wave height within the model.



**Table 1: Experimental Parameters**  
**(Model Scale = 1/25)**

<b>Parameters</b>	<b>Prototype</b>	<b>Model</b>
<b>Wave Period</b>	<b>5.5 Sec</b>	<b>1.1 Sec</b>
	<b>13.0 Sec</b>	<b>2.6 Sec</b>
<b>Wave Height</b>	<b>1.25 m</b>	<b>0.05 m</b>
	<b>1.75 m</b>	<b>0.07 m</b>
	<b>2.50 m</b>	<b>0.10 m</b>
	<b>3.50 m</b>	<b>0.14 m</b>
<b>Water Depth</b>	<b>10 m</b>	<b>0.40 m</b>

Table 2: Horizontal Forces computed by Sainflou's Method

Sl. No.	Wave period (Sec)	Wave length (m)	Wave height (m)	$\theta$ (m)	$P_2$ ( $t/m^2$ )	$P_1$ ( $t/m^2$ )	$P_1$ ( $t/m^2$ )	$F_{Hcr}$ (Kg)	$F_{Htr}$ (kg)	$F_{Hav}$ (Kg)
1	1.1	1.70	0.05	0.00513	0.0217	0.0511	0.0449	4.79	3.84	4.32
2			0.07	0.01004	0.0303	0.0718	0.0600	6.99	5.16	6.08
3			0.10	0.02050	0.0433	0.1026	0.0795	10.61	6.86	8.74
4			0.14	0.04019	0.0607	0.1431	0.0998	16.09	8.72	12.41
5	2.6	4.94	0.05	0.00339	0.0442	0.0523	0.0466	5.82	5.13	5.48
6			0.07	0.00664	0.0619	0.0743	0.0634	8.25	6.93	7.59
7			0.10	0.0136	0.0884	0.1080	0.0864	12.00	9.34	10.67
8			0.14	0.0266	0.1237	0.1540	0.1134	17.28	12.12	14.70

Table 3: Uplift Forces computed by Sainflou's Method.

Sl. No.	Wave period (Sec)	Wave length (m)	Wave height (m)	Fu on 57° wall (Kg)	Fu on 65° wall (Kg)
1	1.1	1.70	0.05	2.03	1.74
2			0.07	2.84	2.42
3			0.10	4.06	3.46
4			0.14	5.69	4.85
5	2.6	4.94	0.05	4.14	3.53
6			0.07	5.80	4.95
7			0.10	8.28	7.07
8			0.14	11.59	9.89

Table 4: Ratios of the Wave Heights within the Models and the Incident Wave Heights in Different Cases.

Sl. No.	Type of Model	Incident wave height (m)	1.1 Sec Wave Hc/2H	2.6 Sec Wave Hc/2H
1	57° (65°) wall with 16% perforations	0.05	0.65 (0.61)	1.13 (1.10)
		0.07	0.57 (0.57)	0.97 (0.96)
		0.10	0.52 (0.54)	0.83 (0.84)
		0.14	0.51 (0.51)	0.73 (0.77)
2	57° (65°) wall with 21% perforations	0.05	0.76 (0.82)	1.33 (1.25)
		0.07	0.69 (0.74)	1.17 (1.05)
		0.10	0.64 (0.70)	1.00 (0.98)
		0.14	0.58 (0.68)	0.93 (0.87)
3	57° (65°) wall with spikes and 16% perforations	0.05	0.54 (0.68)	1.02 (1.06)
		0.07	0.56 (0.52)	0.89 (0.97)
		0.10	0.48 (0.47)	0.80 (0.84)
		0.14	0.42 (0.42)	0.72 (0.77)
4	57° (65°) wall with spikes and 21% perforations	0.05	0.71 (0.81)	1.23 (1.23)
		0.07	0.64 (0.71)	1.12 (1.05)
		0.10	0.58 (0.70)	0.98 (0.98)
		0.14	0.55 (0.67)	0.90 (0.92)

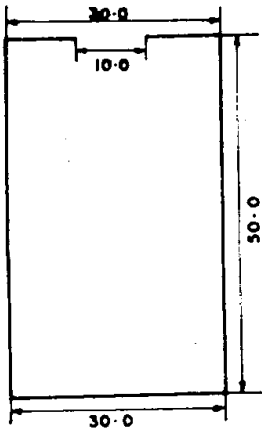

(a) SIDE VIEW OF VERTICAL MODEL

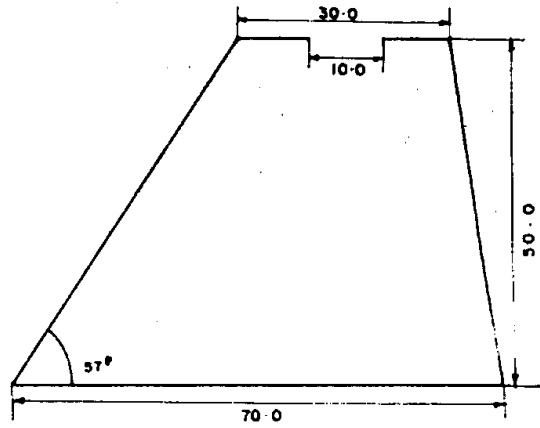

(b) SIDE VIEW OF 57° MODEL

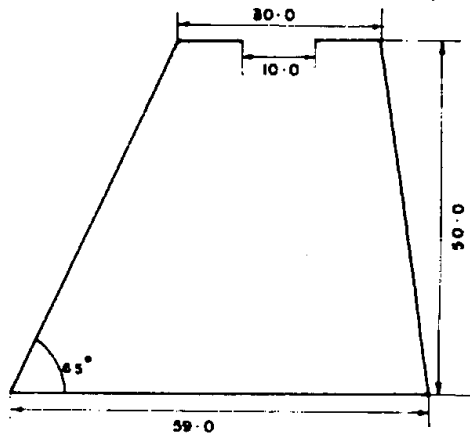

(c) SIDE VIEW OF 65° MODEL

All dimensions in Cms.

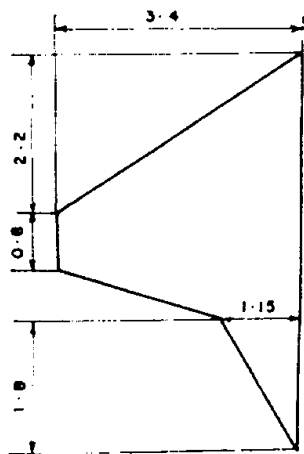
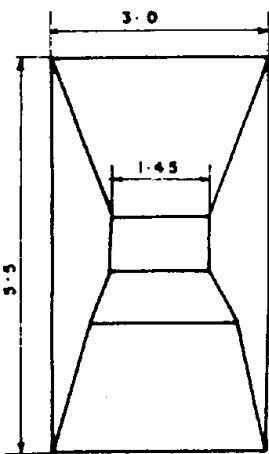
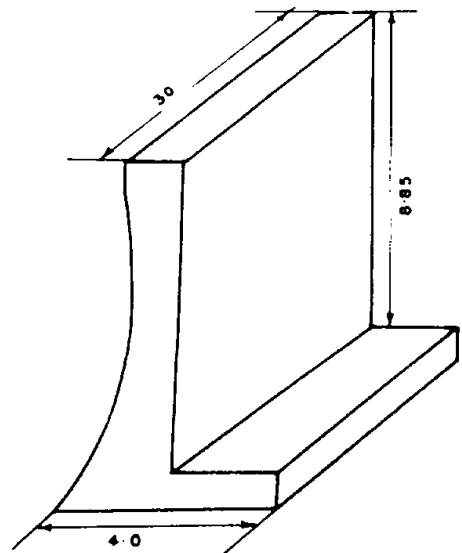
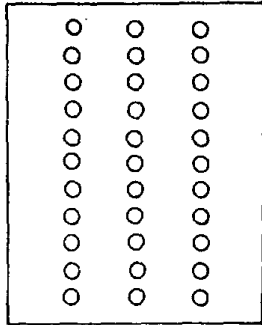

Fig. 3 SPIKES



WAVE REFLECTOR

Fig. 4. WALL TO PREVENT OVERTOPPING



(a) 16% PERFORATIONS

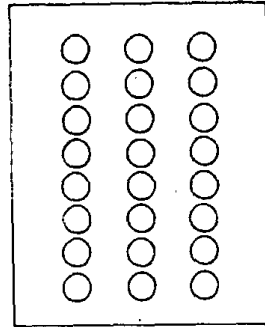

(b) 21% PERFORATIONS

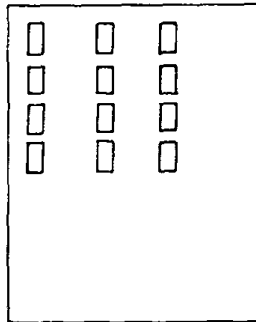

(c) SPIKES ONLY

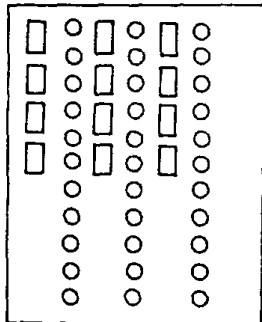

(d) SPIKES & 16% PERFORATIONS

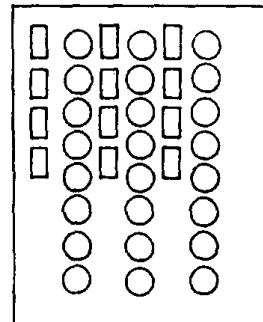

(e) SPIKES & 21% PERFORATIONS

Fig. 2. MODELS WITH PERFORATIONS AND SPIKES

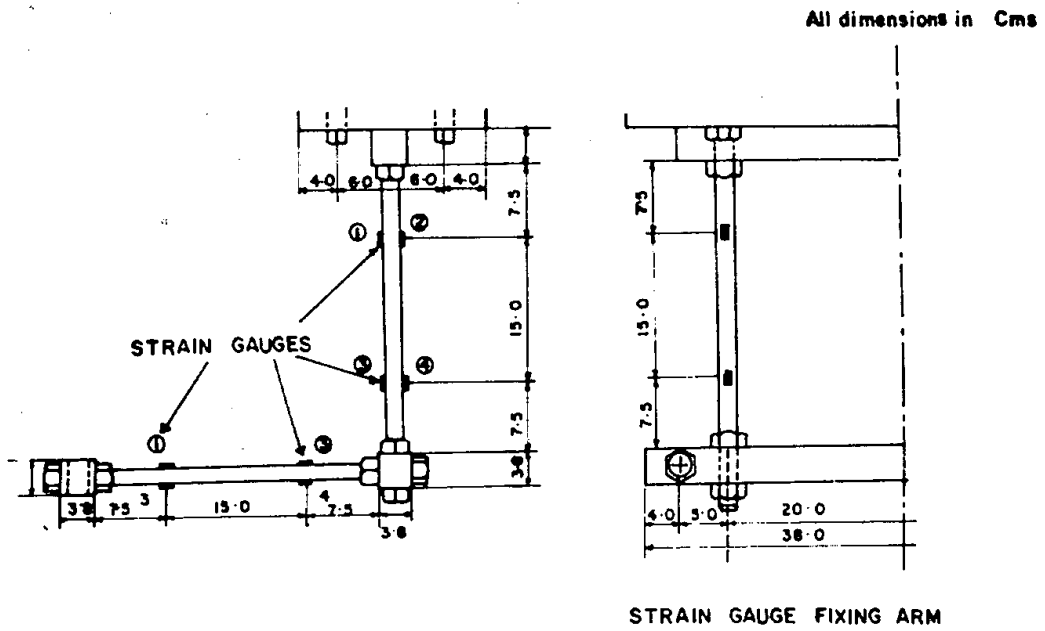
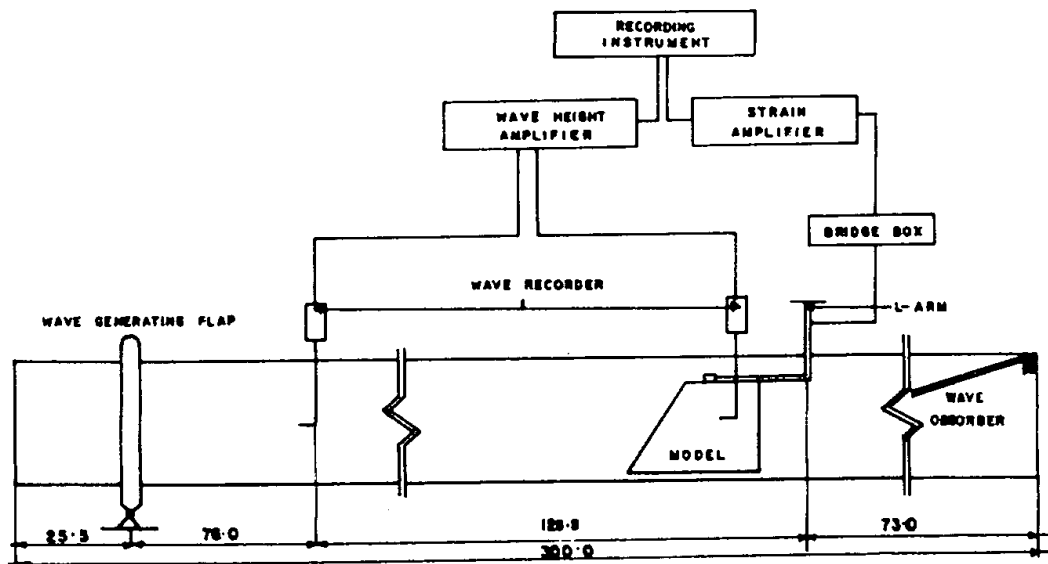

Fig.5 . L- ARM FOR SUPPORTING THE MODEL .



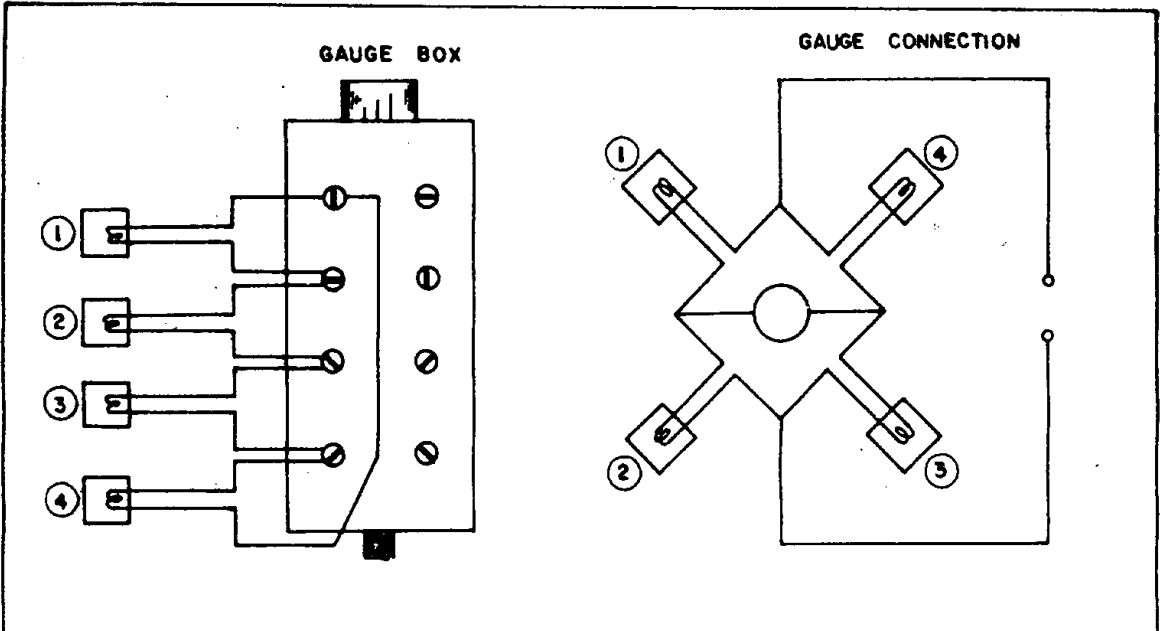

Fig. 7. STRAIN GAUGE CONNECTION.

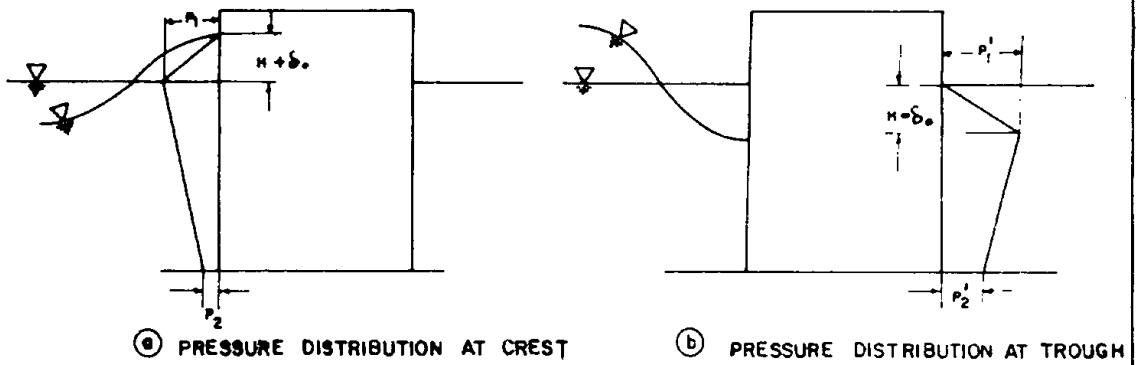

Fig. 8. HORIZONTAL PRESSURE DISTRIBUTION.

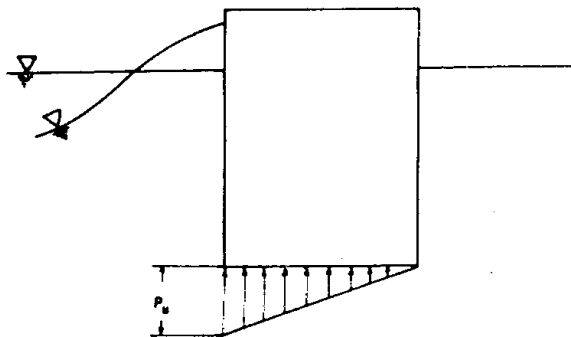

Fig. 9. UPLIFT PRESSURE DISTRIBUTION.



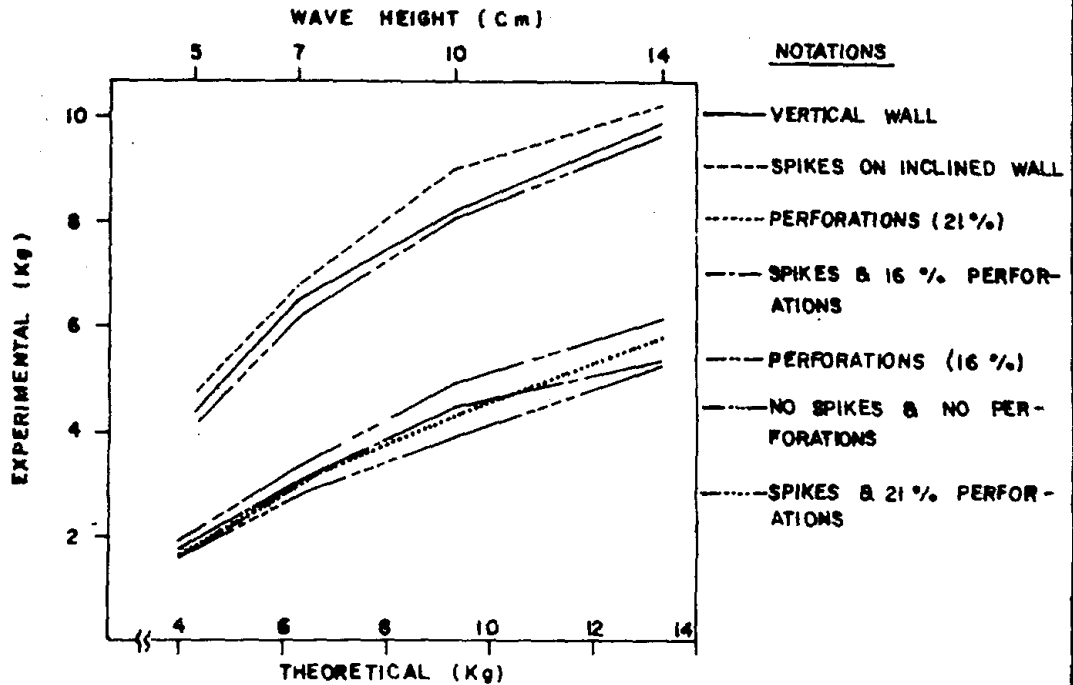

Fig.10. COMPARISON OF EXPERIMENTAL VALUES OF HORIZONTAL FORCE WITH THEORETICAL VALUES (SAINFLOU'S) FOR VERTICAL & 57° WALLS FOR 1.1 Sec WAVE PERIOD.

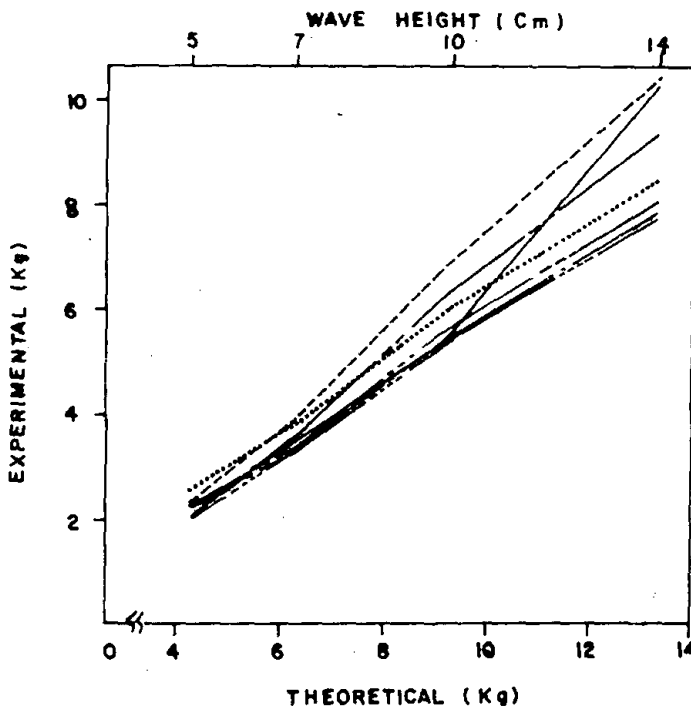

Fig.11. COMPARISON OF EXPERIMENTAL VALUES OF HORIZONTAL FORCE WITH THEORETICAL VALUES (SAINFLOU'S) FOR VERTICAL & 57° WALLS FOR 2.6 Sec WAVE PERIOD.

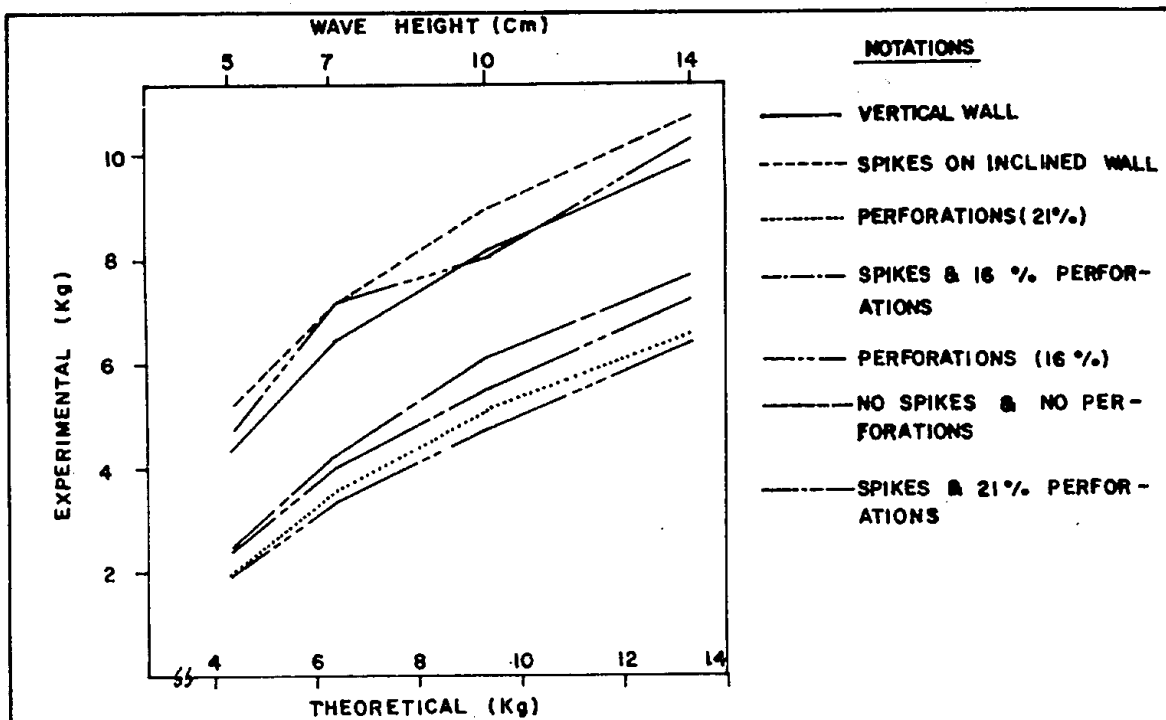

Fig.12. COMPARISON OF EXPERIMENTAL VALUES OF HORIZONTAL FORCE WITH THEORETICAL VALUES (SAINFLOU'S) FOR VERTICAL & 65° WALLS FOR 1.6 Sec. WAVE PERIOD -

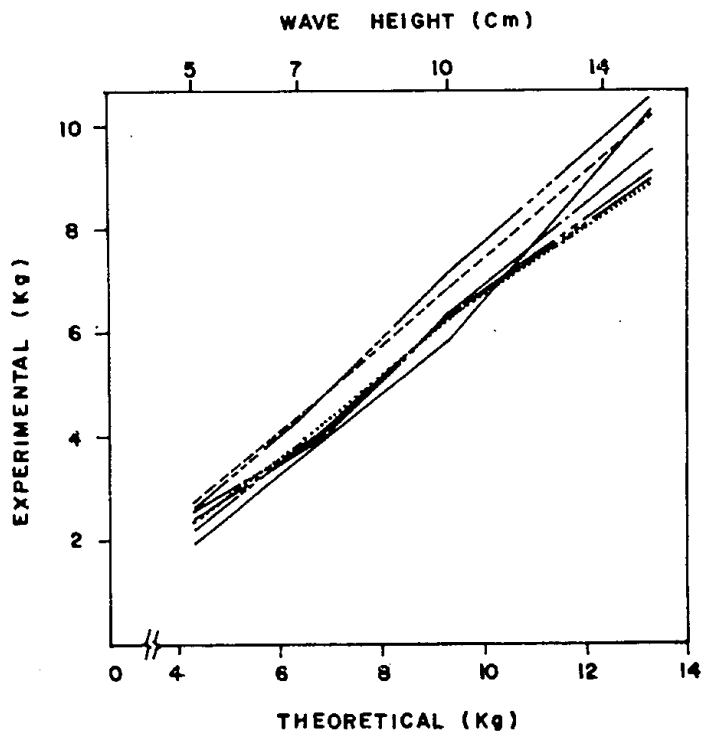

Fig.13. COMPARISON OF EXPERIMENTAL VALUES OF HORIZONTAL FORCE WITH THEORETICAL VALUES (SAINFLOU'S) FOR VERTICAL & 65° WALLS FOR 2.6 Sec. WAVE PERIOD.

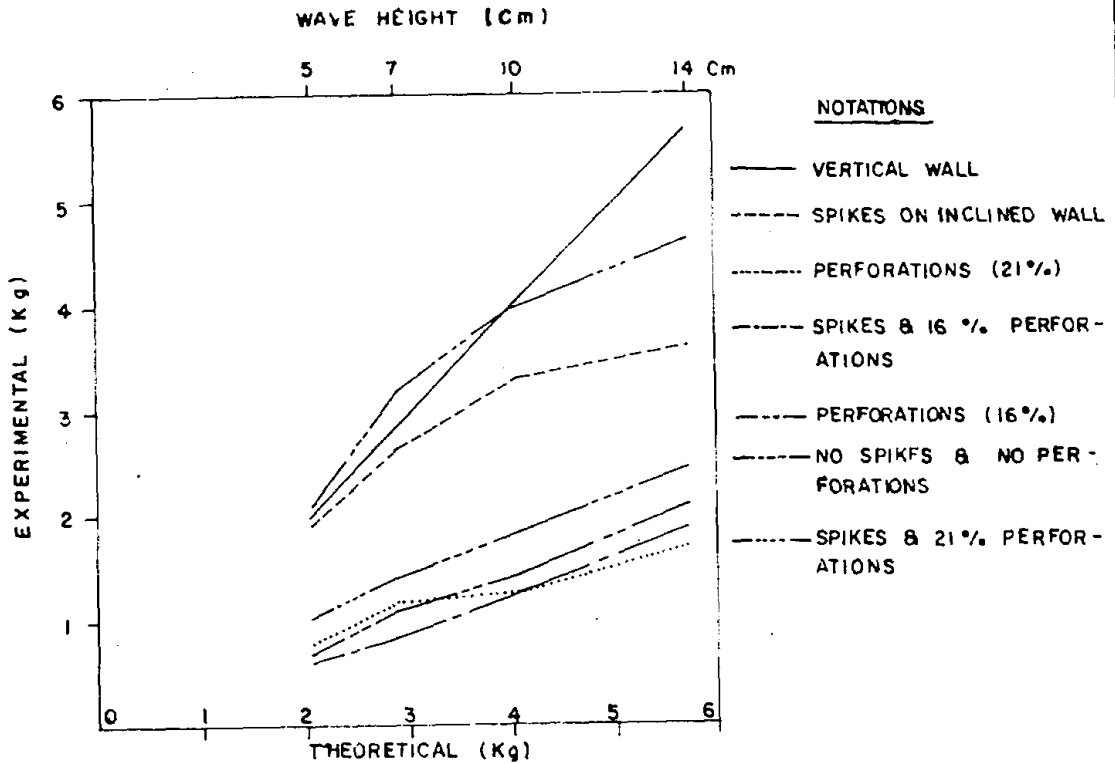

Fig.14. COMPARISON OF EXPERIMENTAL VALUES OF UPLIFT FORCE WITH THEORETICAL VALUES (SAINFLOU'S) FOR VERTICAL & 57° WALLS FOR 1.1 Sec WAVE PERIOD.

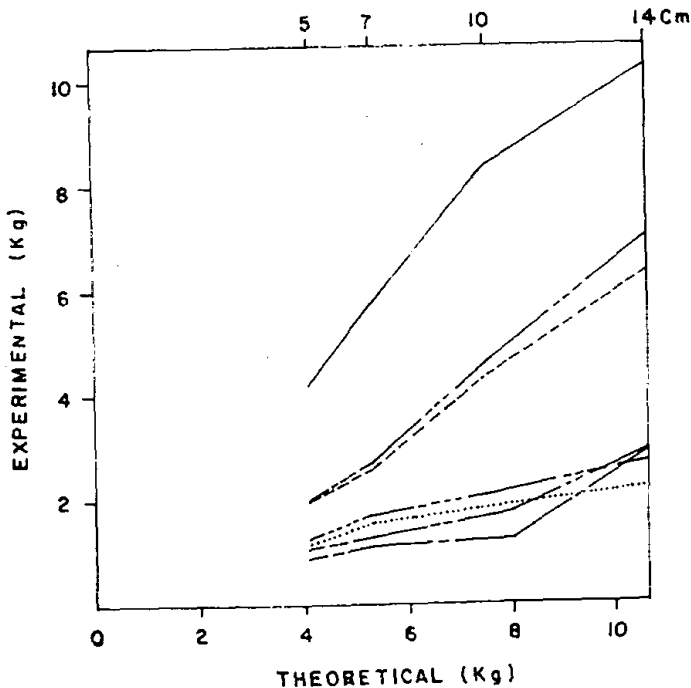

Fig.15. COMPARISON OF EXPERIMENTAL VALUES OF UPLIFT FORCE WITH THEORETICAL VALUES (SAINFLOU'S) FOR VERTICAL & 57° WALLS FOR 2.6 Sec WAVE PERIOD.

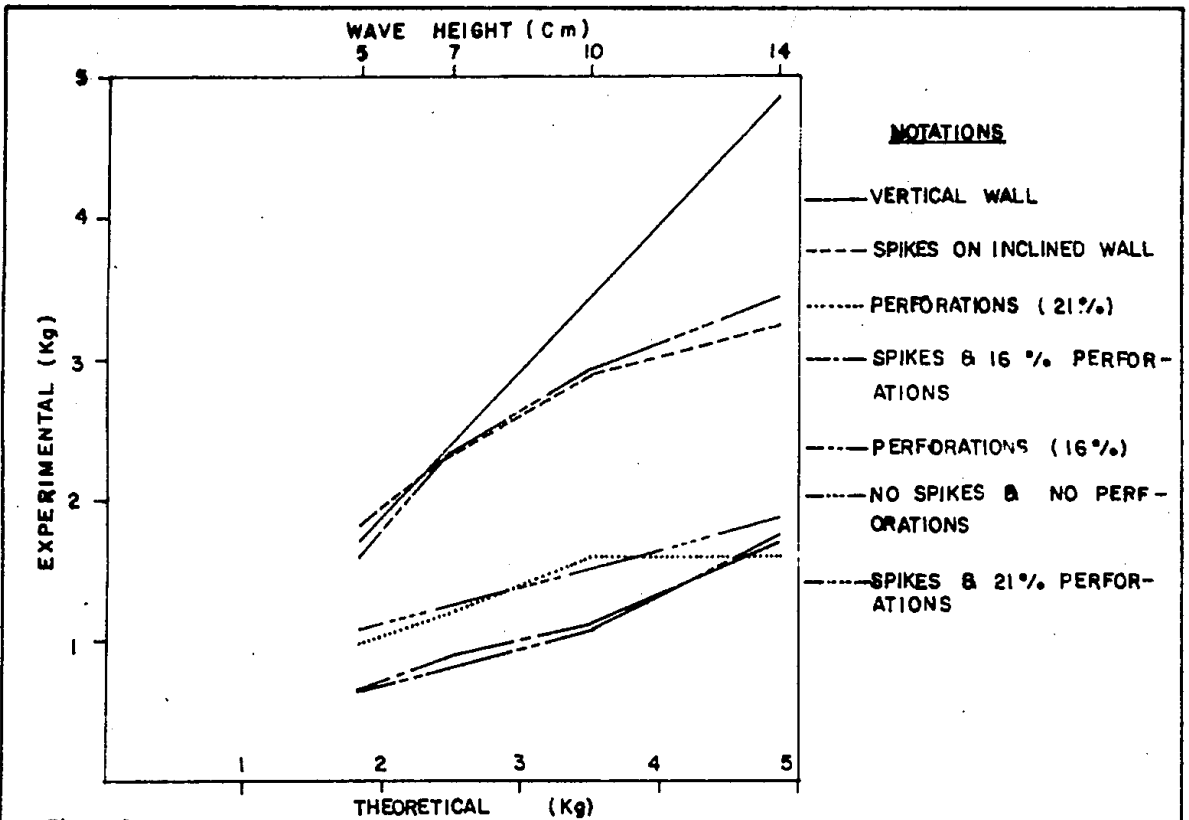

Fig.16. COMPARISON OF EXPERIMENTAL VALUES OF UPLIFT FORCE WITH THEORETICAL VALUES (SAINFLOU'S) FOR VERTICAL & 65° WALLS FOR 1.1 Sec WAVE PERIOD.

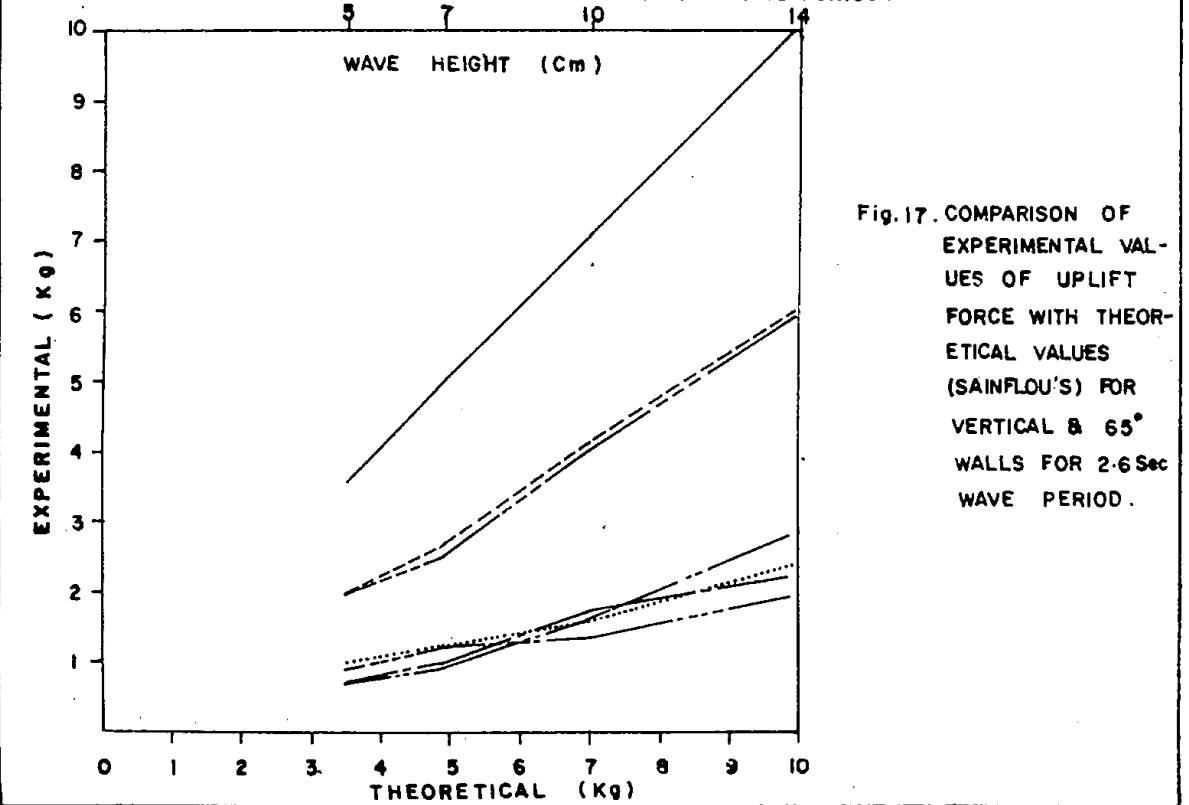

Fig.17. COMPARISON OF EXPERIMENTAL VALUES OF UPLIFT FORCE WITH THEORETICAL VALUES (SAINFLOU'S) FOR VERTICAL & 65° WALLS FOR 2.6 Sec WAVE PERIOD.